

NTS4409N, NVS4409N

MOSFET – Single, N-Channel, Small Signal, ESD Protection, SC-70/SOT-323 25 V, 0.75 A

Features

- Advance Planar Technology for Fast Switching, Low $R_{DS(on)}$
- Higher Efficiency Extending Battery Life
- AEC-Q101 Qualified and PPAP Capable – NVS4409N
- These Devices are Pb-Free and are RoHS Compliant

Applications

- Boost and Buck Converter
- Load Switch
- Battery Protection

MAXIMUM RATINGS ($T_J = 25^\circ\text{C}$ unless otherwise noted)

Rating		Symbol	Value	Unit
Drain-to-Source Voltage		V_{DSS}	25	V
Gate-to-Source Voltage		V_{GS}	± 8.0	V
Drain Current	$t < 5\text{ s}$ $T_A = 25^\circ\text{C}$	I_D	0.75	A
Continuous Drain Current (Note 1)	Steady State $T_A = 25^\circ\text{C}$	I_D	0.7	A
			$T_A = 75^\circ\text{C}$	0.6
Power Dissipation (Note 1)	Steady State	P_D	0.28	W
Power Dissipation (Note 1)	$t \leq 5\text{ s}$	P_D	0.33	W
Pulsed Drain Current	$t_p = 10\ \mu\text{s}$	I_{DM}	3.0	A
Operating Junction and Storage Temperature		T_J, T_{STG}	-55 to +150	$^\circ\text{C}$
Source Current (Body Diode) (Note 1)		I_S	0.3	A
Lead Temperature for Soldering Purposes (1/8" from case for 10 s)		T_L	260	$^\circ\text{C}$
ESD Rating – Machine Model			25	V

THERMAL RESISTANCE RATINGS

Rating	Symbol	Max	Unit
Junction-to-Ambient – Steady State (Note 1)	$R_{\theta JA}$	450	$^\circ\text{C}/\text{W}$
Junction-to-Ambient – $t \leq 5\text{ s}$ (Note 1)	$R_{\theta JA}$	375	

Stresses exceeding Maximum Ratings may damage the device. Maximum Ratings are stress ratings only. Functional operation above the Recommended Operating Conditions is not implied. Extended exposure to stresses above the Recommended Operating Conditions may affect device reliability.

1. Surface mounted on FR4 board using 1 in sq pad size (Cu area = 1.127 in sq [1 oz] including traces).



ON Semiconductor®

<http://onsemi.com>

$V_{(BR)DSS}$	$R_{DS(on)}$ Typ	I_D Max
25 V	249 m Ω @ 4.5 V	0.75 A
	299 m Ω @ 2.7 V	

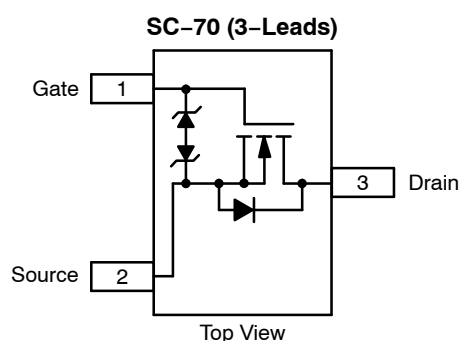

MARKING DIAGRAM & PIN ASSIGNMENT

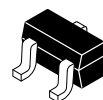

SC-70/SOT-323
CASE 419
STYLE 8

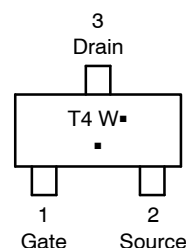

T4 = Device Code
W = Work Week
▪ = Pb-Free Package
(Note: Microdot may be in either location)

ORDERING INFORMATION

Device	Package	Shipping†
NTS4409NT1G	SOT-323 (Pb-Free)	3000 / Tape & Reel
NVS4409NT1G	SOT-323 (Pb-Free)	3000 / Tape & Reel

†For information on tape and reel specifications, including part orientation and tape sizes, please refer to our Tape and Reel Packaging Specification Brochure, BRD8011/D.

NTS4409N, NVS4409N

ELECTRICAL CHARACTERISTICS ($T_J = 25^\circ\text{C}$ unless otherwise noted)

Characteristic	Symbol	Test Condition	Min	Typ	Max	Unit
----------------	--------	----------------	-----	-----	-----	------

OFF CHARACTERISTICS

Drain-to-Source Breakdown Voltage	$V_{(BR)DSS}$	$V_{GS} = 0\text{ V}, I_D = 250\ \mu\text{A}$	25			V
Drain-to-Source Breakdown Voltage Temperature Coefficient	$V_{(BR)DSS}/T_J$			30		$\text{mV}/^\circ\text{C}$
Zero Gate Voltage Drain Current	I_{DSS}	$V_{GS} = 0\text{ V}, V_{DS} = 20\text{ V}$	$T_J = 25^\circ\text{C}$		0.5	μA
			$T_J = 70^\circ\text{C}$		2.0	
			$T_J = 125^\circ\text{C}$		5.0	
Gate-to-Source Leakage Current	I_{GSS}	$V_{DS} = 0\text{ V}, V_{GS} = 8.0\text{ V}$			100	nA

ON CHARACTERISTICS (Note 2)

Gate Threshold Voltage	$V_{GS(TH)}$	$V_{GS} = V_{DS}, I_D = 250\ \mu\text{A}$	0.65		1.5	V
Negative Threshold Temperature Coefficient	$V_{GS(TH)}/T_J$			-2.0		$\text{mV}/^\circ\text{C}$
Drain-to-Source On Resistance	$R_{DS(on)}$	$V_{GS} = 4.5\text{ V}, I_D = 0.6\text{ A}$		249	350	$\text{m}\Omega$
		$V_{GS} = 2.7\text{ V}, I_D = 0.2\text{ A}$		299	400	
		$V_{GS} = 4.5\text{ V}, I_D = 1.2\text{ A}$		260		
Forward Transconductance	g_{FS}	$V_{DS} = 5.0\text{ V}, I_D = 0.5\text{ A}$		0.5		S

CHARGES AND CAPACITANCES

Input Capacitance	C_{ISS}	$V_{GS} = 0\text{ V}, f = 1.0\text{ MHz}, V_{DS} = 10\text{ V}$		49	60	pF
Output Capacitance	C_{OSS}			22.4	30	
Reverse Transfer Capacitance	C_{RSS}			8.0	12	
Total Gate Charge	$Q_{G(TOT)}$	$V_{GS} = 4.5\text{ V}, V_{DS} = 15\text{ V}, I_D = 0.8\text{ A}$		1.2	1.5	nC
Threshold Gate Charge	$Q_{G(TH)}$			0.2		
Gate-to-Source Charge	Q_{GS}			0.28	0.50	
Gate-to-Drain Charge	Q_{GD}			0.3	0.40	

SWITCHING CHARACTERISTICS (Note 3)

Turn-On Delay Time	$t_{d(ON)}$	$V_{GS} = 4.5\text{ V}, V_{DS} = 15\text{ V}, I_D = 0.7\text{ A}, R_G = 51\ \Omega$		5.0	12	ns
Rise Time	t_r			8.2	8.0	
Turn-Off Delay Time	$t_{d(OFF)}$			23	35	
Fall Time	t_f			41	60	

DRAIN-SOURCE DIODE CHARACTERISTICS

Forward Diode Voltage	V_{SD}	$V_{GS} = 0\text{ V}, I_S = 0.6\text{ A}$	$T_J = 25^\circ\text{C}$		0.82	1.20	V
-----------------------	----------	---	--------------------------	--	------	------	---

2. Pulse Test: pulse width $\leq 300\ \mu\text{s}$, duty cycle $\leq 2\%$.
3. Switching characteristics are independent of operating junction temperatures.

TYPICAL PERFORMANCE CURVES ($T_J = 25^\circ\text{C}$ unless otherwise noted)

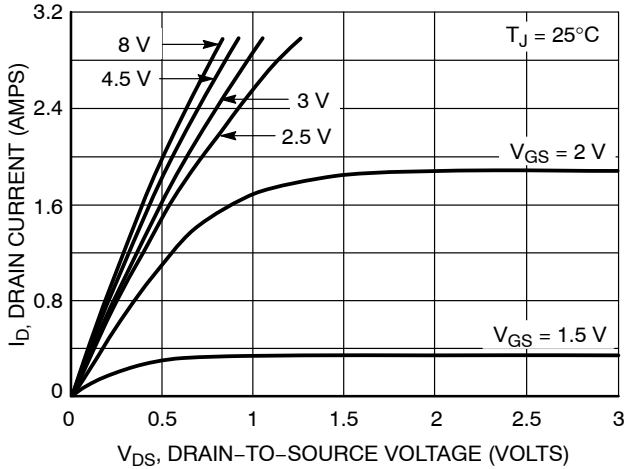

Figure 1. On-Region Characteristics

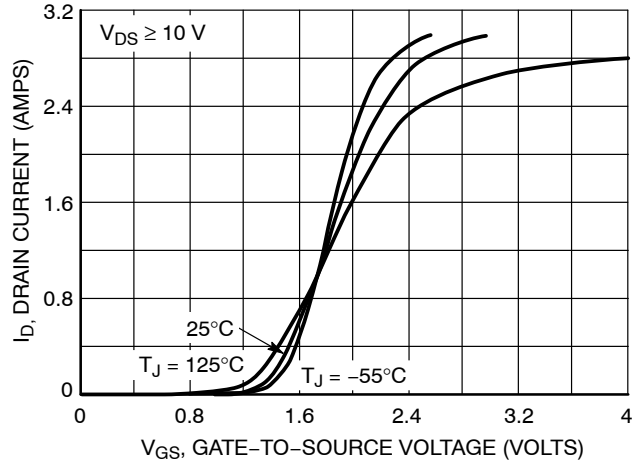

Figure 2. Transfer Characteristics

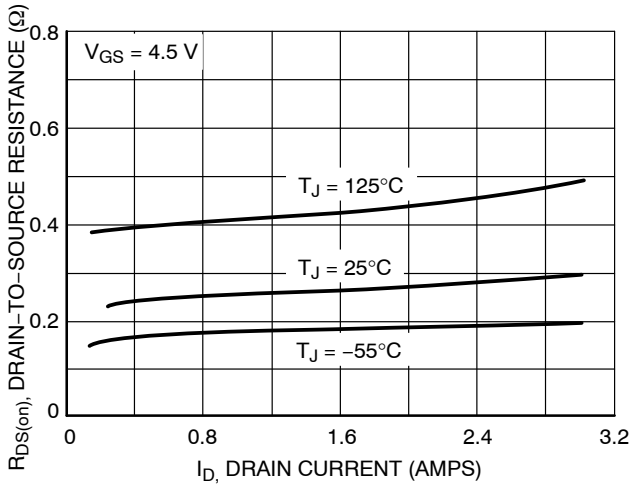

Figure 3. On-Resistance vs. Drain Current and Temperature

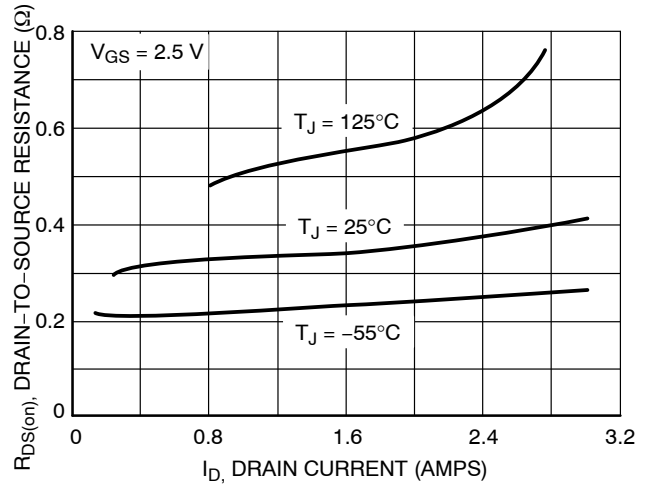

Figure 4. On-Resistance vs. Drain Current and Gate Voltage

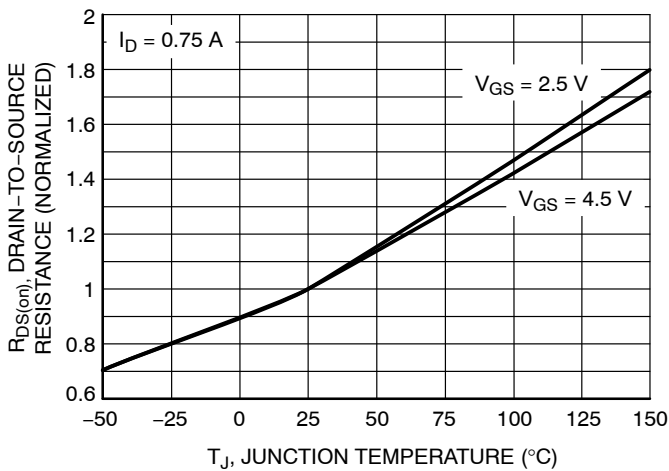

Figure 5. On-Resistance Variation with Temperature

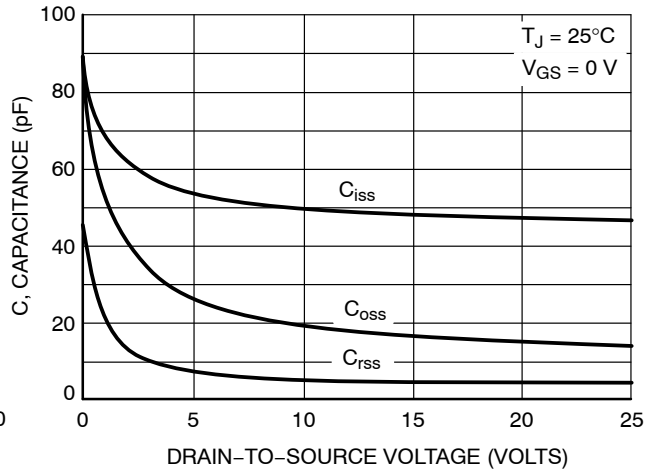

Figure 6. Capacitance Variation

NTS4409N, NVS4409N

TYPICAL PERFORMANCE CURVES ($T_J = 25^\circ\text{C}$ unless otherwise noted)

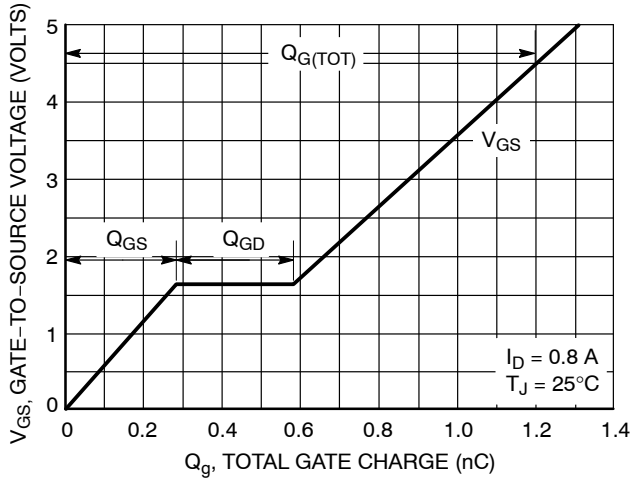

Figure 7. Gate-to-Source and Drain-to-Source Voltage vs. Total Charge

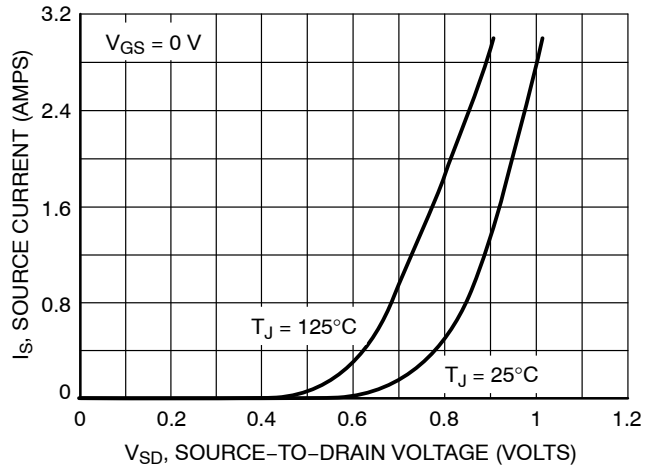
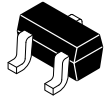

Figure 8. Diode Forward Voltage vs. Current

MECHANICAL CASE OUTLINE PACKAGE DIMENSIONS



SCALE 4:1

SC-70 (SOT-323) CASE 419 ISSUE R

DATE 11 OCT 2022



NOTES:

1. DIMENSIONING AND TOLERANCING PER ASME Y14.5M, 1982.
2. CONTROLLING DIMENSION: INCH

DIM	MILLIMETERS			INCHES		
	MIN.	NOM.	MAX.	MIN.	NOM.	MAX.
A	0.80	0.90	1.00	0.032	0.035	0.040
A1	0.00	0.05	0.10	0.000	0.002	0.004
A2	0.70 REF			0.028 BSC		
b	0.30	0.35	0.40	0.012	0.014	0.016
c	0.10	0.18	0.25	0.004	0.007	0.010
D	1.80	2.00	2.20	0.071	0.080	0.087
E	1.15	1.24	1.35	0.045	0.049	0.053
e	1.20	1.30	1.40	0.047	0.051	0.055
e1	0.65 BSC			0.026 BSC		
L	0.20	0.38	0.56	0.008	0.015	0.022
H _E	2.00	2.10	2.40	0.079	0.083	0.095

GENERIC MARKING DIAGRAM



- XX = Specific Device Code
- M = Date Code
- = Pb-Free Package

*This information is generic. Please refer to device data sheet for actual part marking. Pb-Free indicator, "G" or microdot "▪", may or may not be present. Some products may not follow the Generic Marking.

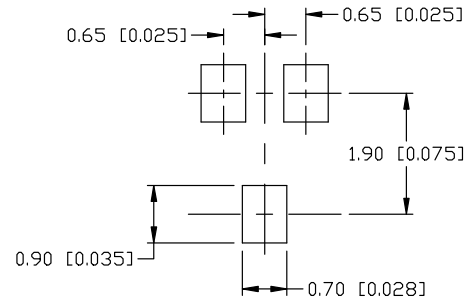

* For additional information on our Pb-Free strategy and soldering details, please download the DN Semiconductor Soldering and Mounting Techniques Reference Manual, SOLDERM/D.

SOLDERING FOOTPRINT

STYLE 1: CANCELLED	STYLE 2: PIN 1. ANODE 2. N.C. 3. CATHODE	STYLE 3: PIN 1. BASE 2. EMITTER 3. COLLECTOR	STYLE 4: PIN 1. CATHODE 2. CATHODE 3. ANODE	STYLE 5: PIN 1. ANODE 2. ANODE 3. CATHODE
STYLE 6: PIN 1. EMITTER 2. BASE 3. COLLECTOR	STYLE 7: PIN 1. BASE 2. EMITTER 3. COLLECTOR	STYLE 8: PIN 1. GATE 2. SOURCE 3. DRAIN	STYLE 9: PIN 1. ANODE 2. CATHODE 3. CATHODE-ANODE	STYLE 10: PIN 1. CATHODE 2. ANODE 3. ANODE-CATHODE
				STYLE 11: PIN 1. CATHODE 2. CATHODE 3. CATHODE

DOCUMENT NUMBER:	98ASB42819B	Electronic versions are uncontrolled except when accessed directly from the Document Repository. Printed versions are uncontrolled except when stamped "CONTROLLED COPY" in red.
DESCRIPTION:	SC-70 (SOT-323)	PAGE 1 OF 1

onsemi and ONSEMI are trademarks of Semiconductor Components Industries, LLC dba onsemi or its subsidiaries in the United States and/or other countries. onsemi reserves the right to make changes without further notice to any products herein. onsemi makes no warranty, representation or guarantee regarding the suitability of its products for any particular purpose, nor does onsemi assume any liability arising out of the application or use of any product or circuit, and specifically disclaims any and all liability, including without limitation special, consequential or incidental damages. onsemi does not convey any license under its patent rights nor the rights of others.

onsemi, **Onsemi**, and other names, marks, and brands are registered and/or common law trademarks of Semiconductor Components Industries, LLC dba "**onsemi**" or its affiliates and/or subsidiaries in the United States and/or other countries. **onsemi** owns the rights to a number of patents, trademarks, copyrights, trade secrets, and other intellectual property. A listing of **onsemi**'s product/patent coverage may be accessed at www.onsemi.com/site/pdf/Patent-Marking.pdf. **onsemi** reserves the right to make changes at any time to any products or information herein, without notice. The information herein is provided "as-is" and **onsemi** makes no warranty, representation or guarantee regarding the accuracy of the information, product features, availability, functionality, or suitability of its products for any particular purpose, nor does **onsemi** assume any liability arising out of the application or use of any product or circuit, and specifically disclaims any and all liability, including without limitation special, consequential or incidental damages. Buyer is responsible for its products and applications using **onsemi** products, including compliance with all laws, regulations and safety requirements or standards, regardless of any support or applications information provided by **onsemi**. "Typical" parameters which may be provided in **onsemi** data sheets and/or specifications can and do vary in different applications and actual performance may vary over time. All operating parameters, including "Typicals" must be validated for each customer application by customer's technical experts. **onsemi** does not convey any license under any of its intellectual property rights nor the rights of others. **onsemi** products are not designed, intended, or authorized for use as a critical component in life support systems or any FDA Class 3 medical devices or medical devices with a same or similar classification in a foreign jurisdiction or any devices intended for implantation in the human body. Should Buyer purchase or use **onsemi** products for any such unintended or unauthorized application, Buyer shall indemnify and hold **onsemi** and its officers, employees, subsidiaries, affiliates, and distributors harmless against all claims, costs, damages, and expenses, and reasonable attorney fees arising out of, directly or indirectly, any claim of personal injury or death associated with such unintended or unauthorized use, even if such claim alleges that **onsemi** was negligent regarding the design or manufacture of the part. **onsemi** is an Equal Opportunity/Affirmative Action Employer. This literature is subject to all applicable copyright laws and is not for resale in any manner.

ADDITIONAL INFORMATION

TECHNICAL PUBLICATIONS:

Technical Library: www.onsemi.com/design/resources/technical-documentation
onsemi Website: www.onsemi.com

ONLINE SUPPORT: www.onsemi.com/support

For additional information, please contact your local Sales Representative at www.onsemi.com/support/sales