

Powerex, Inc., 200 Hillis Street, Youngwood, Pennsylvania 15697-1800 (412) 925-7272  
 Powerex, Europe, S.A. 428 Avenue G. Durand, BP107, 72003 Le Mans, France (43) 41.14.14

### Phase Control SCR 2500 Amperes Average 2100 Volts

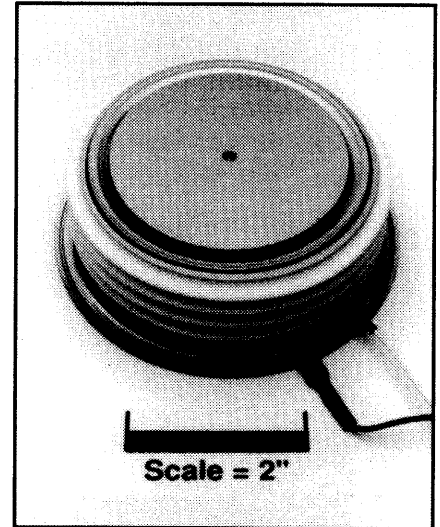
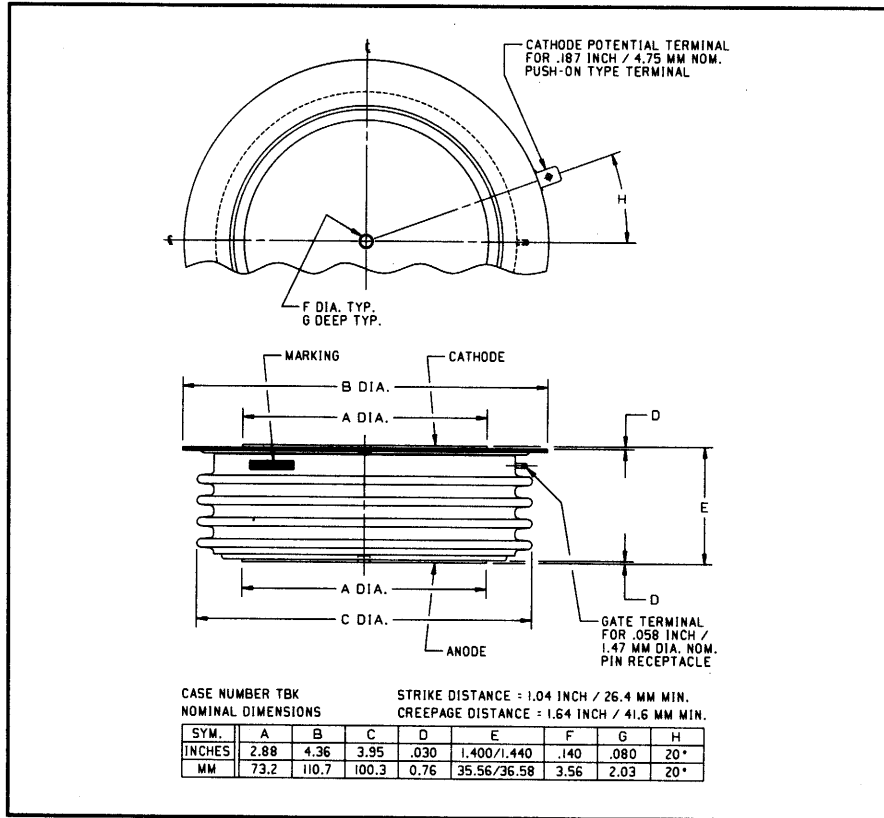

C781 Phase Control SCR  
 2500 Amperes Average, 2100 Volts

C781 (Outline Drawing)

#### Description:

Powerex Silicon Controlled Rectifiers (SCR) are designed for phase control applications. These are all-diffused, Press-Pak, hermetic Pow-R-Disc devices employing the field proven amplifying gate.

#### Features:

- Low On-State Voltage
- High di/dt Capability
- High dv/dt Capability
- Hermetic Packaging
- Excellent Surge and  $I^2t$  Ratings

#### Applications:

- Power Supplies
- Motor Control

#### Ordering Information:

Select the complete five or six digit part number you desire from the table, i.e. C781LA is a 2100 Volt, 2500 Ampere Phase Control SCR.

Type	Voltage		Current
	$V_{DRM}$	Code	$I_{T(av)}$
C781	1200	PB	2500
	1400	PD	
	1600	PM	
	1800	PN	
	2000	L	
	2100	LA	

**C781**  
**Phase Control SCR**  
 2500 Amperes Average, 2100 Volts

## Absolute Maximum Ratings

Characteristics	Symbol	C781	Units
Non-repetitive Transient Peak Reverse Voltage	$V_{RSM}$	$V_{RRM} + 100V$	Volts
RMS On-state Current, $T_C = 72^\circ C$	$I_T(rms)$	3925	Amperes
Average Current 180° Sine Wave, $T_C = 72^\circ C$	$I_T(av)$	2500	Amperes
RMS On-state Current, $T_C = 55^\circ C$	$I_T(rms)$	4820	Amperes
Average Current 180° Sine Wave, $T_C = 55^\circ C$	$I_T(av)$	3070	Amperes
Peak One Cycle Surge On-state Current (Non-repetitive) 60Hz	$I_{tsm}$	45000	Amperes
Peak One Cycle Surge On-state Current (Non-repetitive) 50Hz	$I_{tsm}$	41500	Amperes
Critical Rate-of-rise of On-state Current (Non-repetitive)	$di/dt$	600	A/ $\mu$ sec
Critical Rate-of-rise of On-state Current (Repetitive)	$di/dt$	100	A/ $\mu$ sec
$I^2t$ (for Fusing) for One Cycle, 60Hz	$I^2t$	$8.5 \times 10^6$	A <sup>2</sup> sec
Peak Gate Power Dissipation	$P_{GM}$	250	Watts
Average Gate Power Dissipation	$P_{G(av)}$	35	Watts
Operating Temperature	$T_j$	-40 to +125°C	°C
Storage Temperature	$T_{stg}$	-40 to +150°C	°C
Approximate Weight		3.5	lb.
		1.60	kg
Mounting Force		9000 to 10000	lb.
		40 to 44.5	kN

C781  
 Phase Control SCR  
 2500 Amperes Average, 2100 Volts

## Electrical Characteristics, $T_j = 25^\circ\text{C}$ Unless Otherwise Specified

Characteristics	Symbol	Test Conditions	Min.	Typ.	Max.	Units
Repetitive Peak Reverse Leakage Current	$I_{RRM}$	$T_j = 125^\circ\text{C}, V_R = V_{RRM}$			150	mA
Repetitive Peak Forward Leakage Current	$I_{DRM}$	$T_j = 125^\circ\text{C}, V_D = V_{DRM}$			150	mA
Peak On-state Voltage	$V_{TM}$	$T_j = 125^\circ\text{C}, I_T = 2000\text{A Peak}$ Duty Cycle < 0.1%			1.20	Volts
Threshold Voltage, Low-level	$V_{(TO)1}$	$T_j = 125^\circ\text{C}, I = 15\%, I_{T(av)}$ to $\pi I_{T(av)}$			0.94963	Volts
Slope Resistance, Low-level	$r_{T1}$				0.1234	m $\Omega$
Threshold Voltage, High-level	$V_{(TO)2}$	$T_j = 125^\circ\text{C}, I = \pi I_{T(av)}$ to $I_{TSM}$			1.1007	Volts
Slope Resistance, High-level	$r_{T2}$				0.1149	m $\Omega$
$V_{TM}$ Coefficients, Low-level		$T_j = 125^\circ\text{C}, I = 15\% I_{T(av)}$ to $\pi I_{T(av)}$			$A_1 = -0.007132$ $B_1 = 0.18721$ $C_1 = 1.589\text{E-}04$ $D_1 = -0.011393$	
$V_{TM}$ Coefficients, High-level		$T_j = 125^\circ\text{C}, I = \pi I_{T(av)}$ to $I_{TSM}$			$A_2 = 30.510$ $B_2 = -4.6029$ $C_2 = -2.083\text{E-}04$ $D_2 = 0.1610$	
Typical Delay Time	$t_d$	$T_j = 125^\circ\text{C}, V_D = 1500\text{V}$		3		$\mu\text{sec}$
Typical Turn-off Time	$t_q$	$T_j = 125^\circ\text{C}, I_T = 2000\text{A},$ $t_p > 3\text{msec}, di_T/dt = 5\text{A}/\mu\text{sec},$ V Reapplied = 1000V, $dv/dt = 1000\text{V}/\mu\text{sec}, V_R = 100\text{V}$		250		$\mu\text{sec}$
Minimum Critical $dv/dt$ - Exponential to $V_{DRM}$	$dv/dt$	$T_j = 125^\circ\text{C}, V_D = 0.8 V_{DRM}$	500			V/ $\mu\text{sec}$
Gate Trigger Current	$I_{GT}$	$T_j = 25^\circ\text{C}, V_D = 12\text{V}_{DC}$			250	mA
Gate Trigger Voltage	$V_{GT}$	$T_j = 25^\circ\text{C}, V_D = 12\text{V}_{DC}$			4.2	Volts
Non-Triggering Gate Voltage	$V_{GDM}$	$T_j = 125^\circ\text{C}, V_D = 1000\text{V}$			0.5	Volts
Peak Forward Gate Current	$I_{GTM}$				20	A
Peak Reverse Gate Voltage	$V_{GRM}$				20	Volts

## Thermal Characteristics

Maximum Thermal Resistance, Double Sided Cooling

Junction-to-Case	$R_{\theta(j-c)}$			0.012	$^\circ\text{C}/\text{W}$
Case-to-Sink	$R_{\theta(c-s)}$			0.002	$^\circ\text{C}/\text{W}$

**C781**  
**Phase Control SCR**  
 1500 Amperes Average, 2400 Volts

**Maximum On-State Forward Voltage Drop**  
 ( $T_J = 125^\circ\text{C}$ )

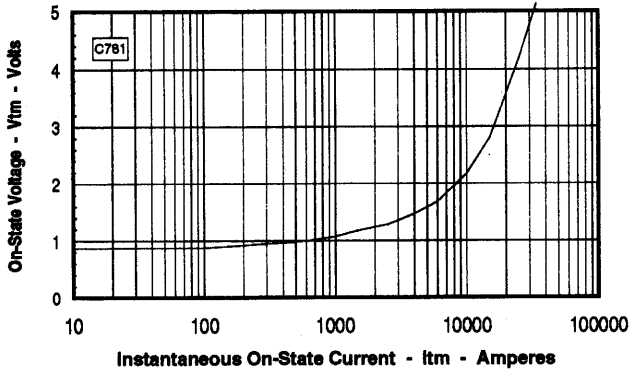

**Maximum Transient Thermal Impedance**  
 (Junction to Case)

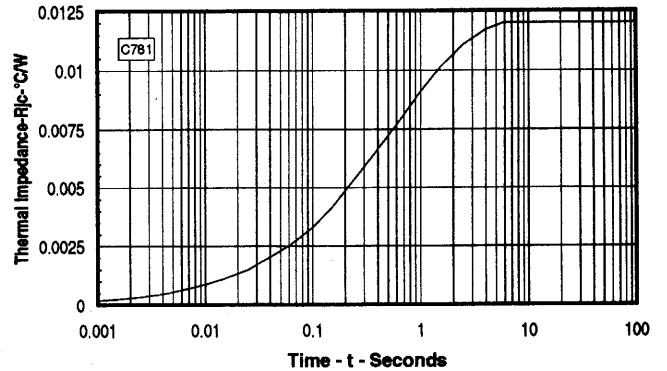

**Maximum On-State Power Dissipation**  
 (Sinusoidal Waveform)

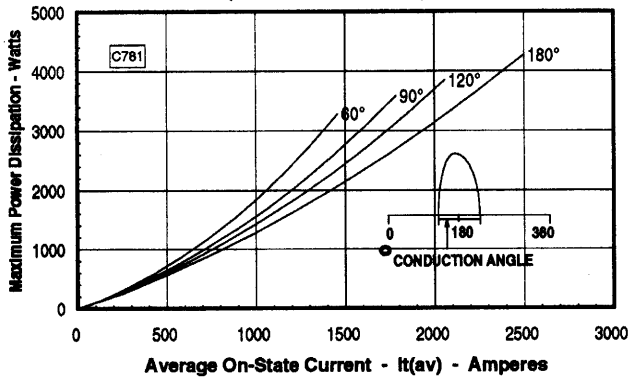

**Maximum Allowable Case Temperature**  
 (Sinusoidal Waveform)

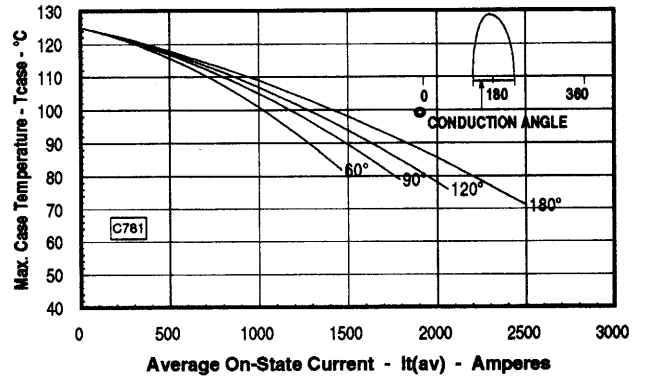

**Maximum On-State Power Dissipation**  
 (Rectangular Waveform)

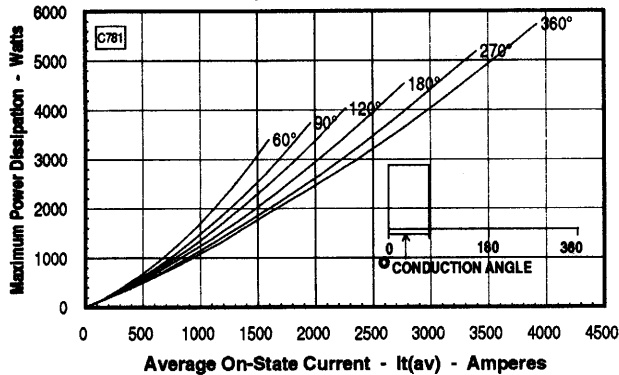

**Maximum Allowable Case Temperature**  
 (Rectangular Waveform)

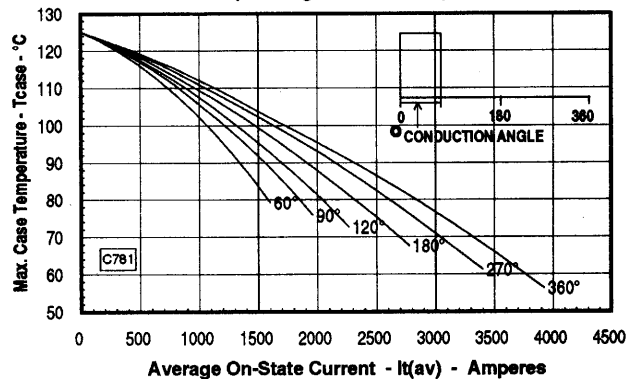

Note: Spreading losses included. Curves are for an inductive load.