

SMD Power Inductor

CDRR7D45/T125



Description

- Ferrite drum core construction
- Magnetically shielded
- LxWxH: 7.2x7.2x4.8 mm Max.
- Product weight:0.6 g(Ref.)
- Moisture Sensitivity Level: 1
- RoHS compliance



Environmental Data

- Operating Temperature: -40°C to +125°C (including self-heating)
- Storage temperature range: -40°C~+125°C

Packaging

- Carrier tape and reel packaging

Applications

- High temp and high reliability automotive applications

Dimension - [mm]

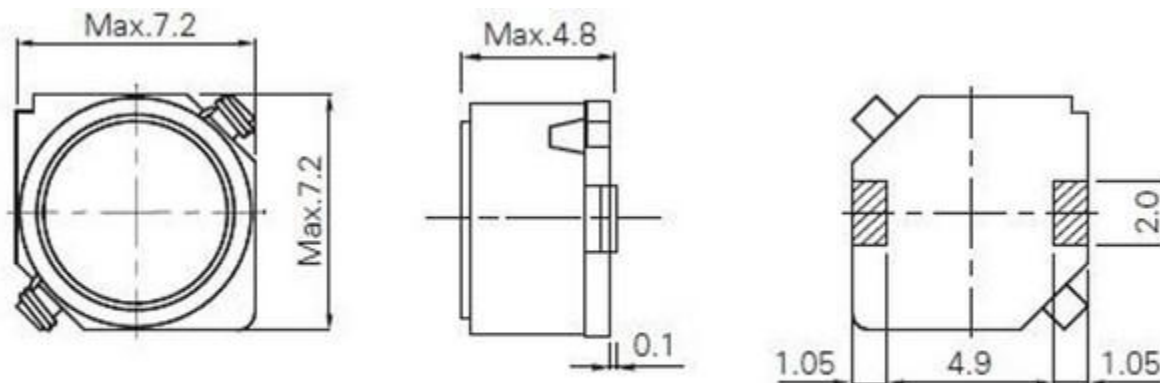

*Dimension does not include the soldering joint between the coil and terminal

Recommended Land pattern - [mm]



Wire Connection

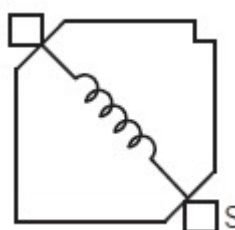

SMD Power Inductor

CDRR7D45/T125



Electrical Characteristics

Part Number	Inductance [Within] (μ H) ※1	D.C.R. at 20°C [Within] (m Ω)	Saturation Current (A) Max.(Typ.) ※2	Temperature Rise Current (A) Max.(Typ.) ※3
CDRR7D45T125NP-3R3MC	3.30 \pm 20%	28.00 \pm 20%	3.50 (4.40)	3.20 (3.65)
CDRR7D45T125NP-4R7MC	4.70 \pm 20%	31.00 \pm 20%	2.80 (3.58)	2.90 (3.34)
CDRR7D45T125NP-6R8MC	6.80 \pm 20%	39.00 \pm 20%	2.40 (3.02)	2.45 (2.81)
CDRR7D45T125NP-100MC	10.00 \pm 20%	47.00 \pm 20%	1.96 (2.47)	2.25 (2.60)
CDRR7D45T125NP-150MC	15.00 \pm 20%	68.00 \pm 20%	1.64 (2.08)	1.85 (2.10)
CDRR7D45T125NP-220MC	22.00 \pm 20%	82.00 \pm 20%	1.36 (1.70)	1.60 (1.82)
CDRR7D45T125NP-330MC	33.00 \pm 20%	120 \pm 20%	1.21 (1.45)	1.30 (1.50)
CDRR7D45T125NP-470MC	47.00 \pm 20%	180 \pm 20%	0.94 (1.17)	1.10 (1.27)
CDRR7D45T125NP-680MC	68.00 \pm 20%	270 \pm 20%	0.78 (0.95)	0.90 (1.04)
CDRR7D45T125NP-101MC	100 \pm 20%	390 \pm 20%	0.62 (0.76)	0.73 (0.85)
CDRR7D45T125NP-151MC	150 \pm 20%	550 \pm 20%	0.52 (0.65)	0.65 (0.74)
CDRR7D45T125NP-221MC	220 \pm 20%	830 \pm 20%	0.44 (0.56)	0.54 (0.60)
CDRR7D45T125NP-331MC	330 \pm 20%	1150 \pm 20%	0.35 (0.46)	0.44 (0.50)
CDRR7D45T125NP-471MC	470 \pm 20%	1800 \pm 20%	0.31 (0.38)	0.36 (0.41)

※1. Inductance measuring condition: at 100 kHz.

※2. Saturation current: The value of D.C. current when the inductance decreases to 90% of it's nominal value.

※3. Temperature rise current: The value of D.C. current when the temperature rise is $\Delta t=40^{\circ}\text{C}$ ($T_a=20^{\circ}\text{C}$).

Solder Reflow Condition

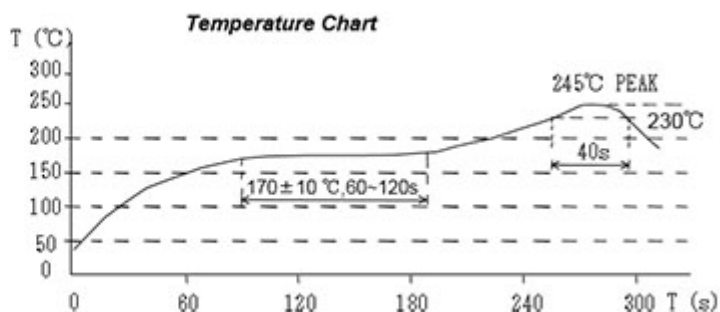
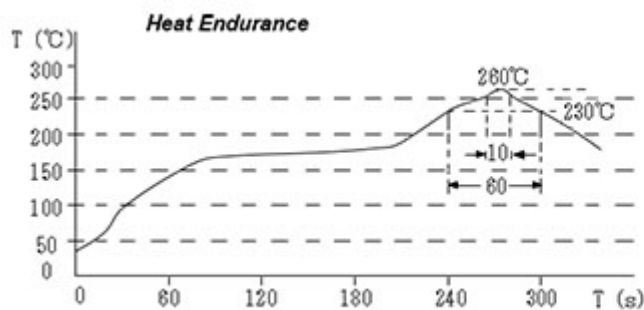

SMD Power Inductor

CDRR7D45/T125



Saturation Current & Temperature Rise Graph

— L (20°C) — ΔT

1. CDRR7D45T125NP-3R3MC

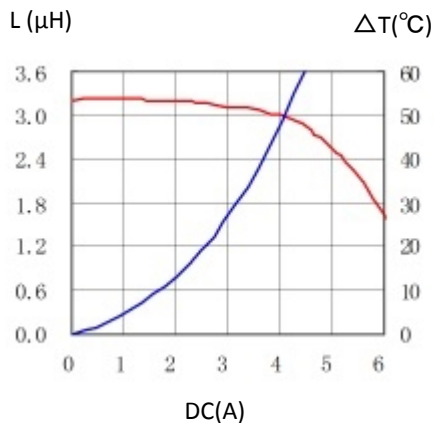

2. CDRR7D45T125NP-4R7MC

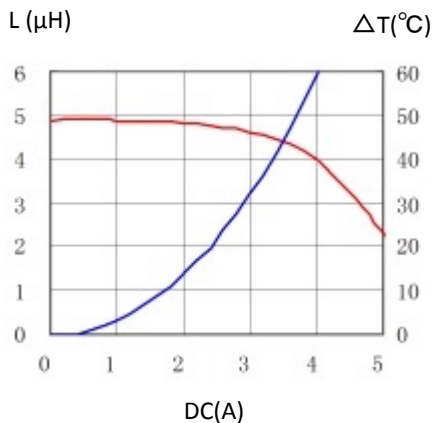

3. CDRR7D45T125NP-6R8MC

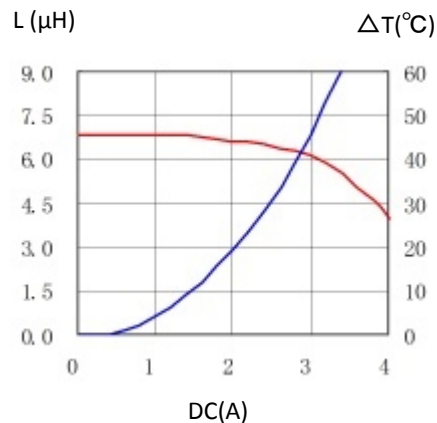

4. CDRR7D45T125NP-100MC

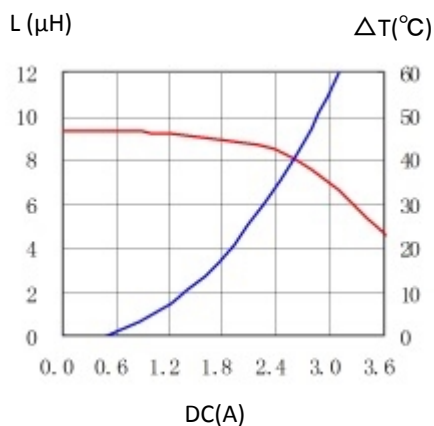

5. CDRR7D45T125NP-150MC

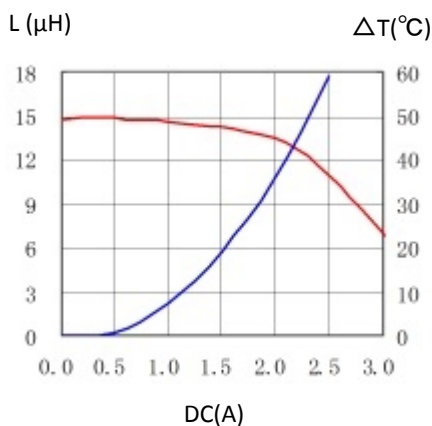

6. CDRR7D45T125NP-220MC

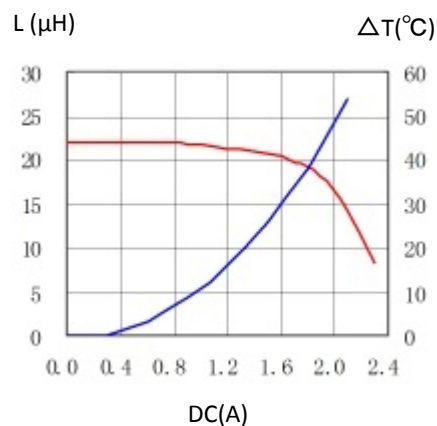

7. CDRR7D45T125NP-330MC

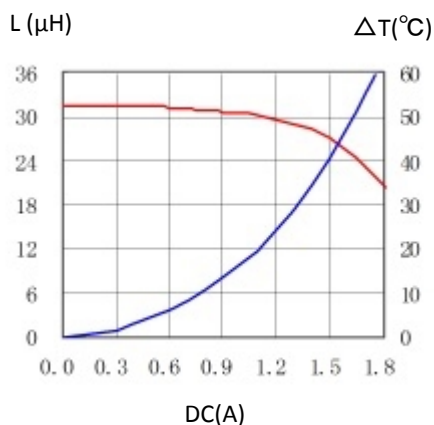

8. CDRR7D45T125NP-470MC

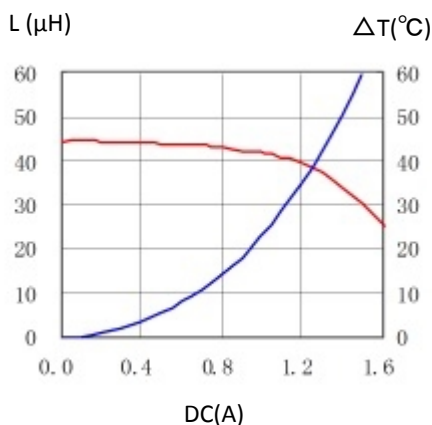

9. CDRR7D45T125NP-680MC

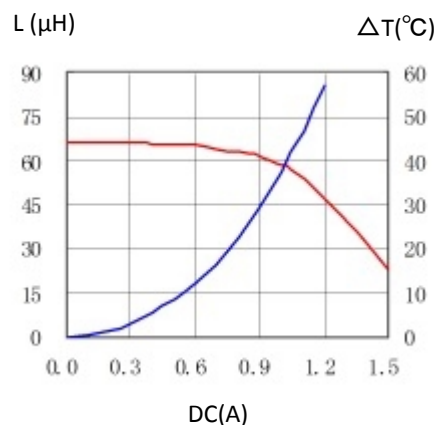

Note: This specification is subject to change without notice. Please contact your nearest sales office for updated information when placing an order.

SMD Power Inductor

CDRR7D45/T125



10. CDRR7D45T125NP-101MC

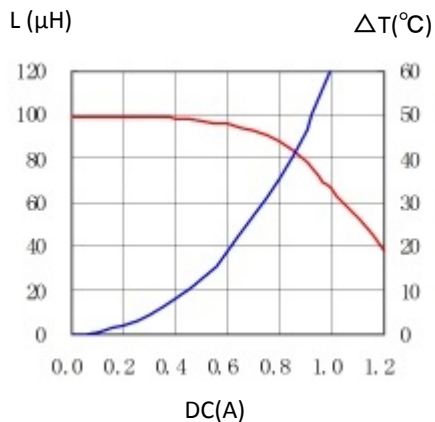

11. CDRR7D45T125NP-151MC

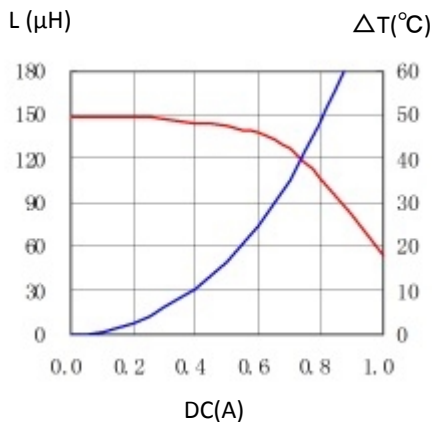

12. CDRR7D45T125NP-221MC

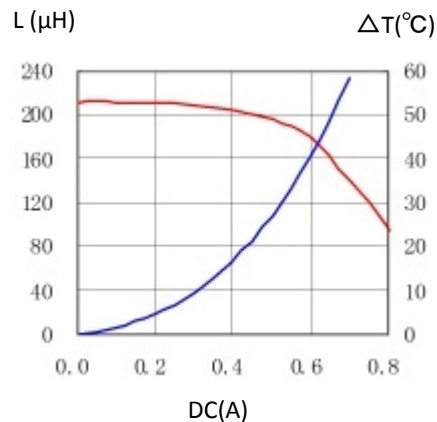

13. CDRR7D45T125NP-331MC

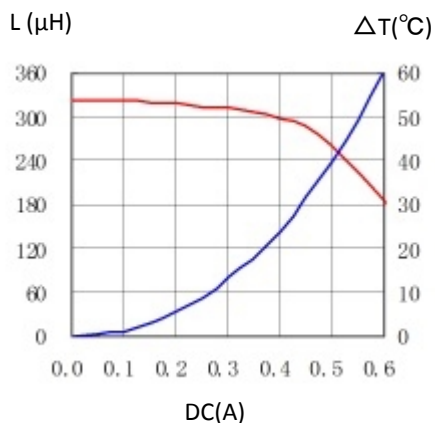

14. CDRR7D45T125NP-471MC

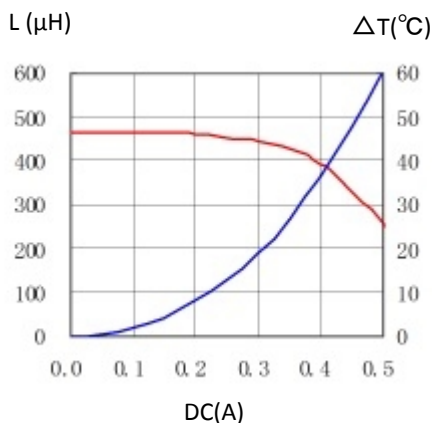

For sales office information, please [click here](#) to visit our website.