

Trench Power MOSFET

Very low $R_{DS(on)}$

$V_{DSS} = 100\text{ V}$
 $I_{D25} = 350\text{ A}$
 $R_{DS(on) \text{ typ.}} = 1.9\text{ m}\Omega$

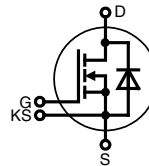

**SOT-227 B,
miniBLOC**

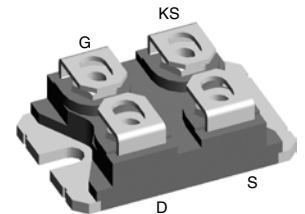

G = Gate, D = Drain,
S = Source, KS = Kelvin Source

MOSFET			
Symbol	Conditions	Maximum Ratings	
V_{DSS}	$T_{VJ} = 25^\circ\text{C}$ to 150°C	100	V
V_{GS}		± 20	V
I_{D25}	$T_C = 25^\circ\text{C}$; limited by leads	350	A
I_{D90}	$T_C = 90^\circ\text{C}$	265	A
$I_{D(RMS)}$	Package lead current limit	150	A
P_D	$T_C = 25^\circ\text{C}$	830	W

Symbol	Conditions	Characteristic Values		
		min.	typ.	max.
$(T_{VJ} = 25^\circ\text{C}, \text{ unless otherwise specified})$				
R_{DSon}	on chip level: $V_{GS} = 10\text{ V}$ $I_D = 175\text{ A}$; pulse test $t \leq 300\ \mu\text{s}$; duty cycle $\leq 2\%$	$T_{VJ} = 25^\circ\text{C}$ $T_{VJ} = 125^\circ\text{C}$	1.9 4	2.5 m Ω
$R_{pin \text{ to chip}}$	$R_{DS} = R_{DS(on)} + R_{pin \text{ to chip}}$		0.8	m Ω
$V_{GS(th)}$	$V_{DS} = V_{GS}$; $I_D = 3\text{ mA}$		2	4 V
I_{DSS}	$V_{DS} = V_{DSS}$; $V_{GS} = 0\text{ V}$	$T_{VJ} = 25^\circ\text{C}$ $T_{VJ} = 125^\circ\text{C}$		30 μA 1.5 mA
I_{GSS}	$V_{GS} = \pm 10\text{ V}$; $V_{DS} = 0\text{ V}$			± 300 nA
C_{iss}	} $V_{GS} = 0\text{ V}$; $V_{DS} = 25\text{ V}$; $f = 1\text{ MHz}$		27	nF
C_{oss}			3	nF
C_{rss}			2	nF
Q_g	} $V_{GS} = 10\text{ V}$; $V_{DS} = 80\text{ V}$; $I_D = 300\text{ A}$		640	nC
Q_{gs}			135	nC
Q_{gd}			275	nC
$t_{d(on)}$	} $V_{GS} = 10\text{ V}$; $V_{DS} = 50\text{ V}$; $I_D = 250\text{ A}$; $R_G = 1.9\ \Omega$ (external)	$T_{VJ} = 125^\circ\text{C}$	115	ns
t_r			175	ns
$t_{d(off)}$			650	ns
t_f			150	ns
E_{on}			1.0	mJ
E_{off}			3.1	mJ
$E_{rec(off)}$			0.32	mJ
R_{thJC}	with heat transfer paste		0.18	K/W
R_{thCH}		0.06	K/W	

Features

- trench MOSFET
- very low on state resistance R_{DSon}
- fast switching
- fast body diode
- industry standard outline
- isolated package
- high reliability

Applications

- automotive
- converters for fuel cells
- AC drives
- choppers to replace series dropping resistors used for motors, heaters etc.
- DC-DC converters
- electronic switches
- replacing relays and fuses
- power supplies
- solar inverters
- battery supplied systems
- choppers or inverters for motor control in hand tools
- battery chargers

Advantages

- Easy to mount
- Space savings
- High power density

Source-Drain Diode

Symbol	Conditions	Characteristic Values		
		min.	typ.	max.
I_s	$V_{GS} = 0\text{ V}$			300
I_{SM}	Repetitive, pulse width limited by T_{JM}			550
V_{SD}	$I_F = 250\text{ A}$; $V_{GS} = 0\text{ V}$ Pulse test, $t \leq 300\ \mu\text{s}$, duty cycle $\leq 2\%$	1.1	1.3	
t_{rr}	$I_F = 350\text{ A}$; $-di_F/dt = 600\text{ A}/\mu\text{s}$; $V_R = 50\text{ V}$		120	ns
I_{RM}			35	A
Q_{RR}			2.8	μC

Component

Symbol	Conditions	Maximum Ratings		
		min.	typ.	max.
T_{VJ}	operating		-55...+150	$^{\circ}\text{C}$
T_{stg}	storage		-55...+150	$^{\circ}\text{C}$
V_{ISOL}	50/60 Hz, RMS, $I_{ISOL} \leq 1\text{ mA}$		2500	V~
	$t = 1\text{ min}$		3000	V~
	$t = 1\text{ s}$			
M_d	mounting torque		1.5	Nm
	terminal connection torque		1.5	Nm

Symbol	Conditions	Characteristic Values		
		min.	typ.	max.
Weight			30	g

SOT-227 B, miniBLOC

Dim.	Millimeter		Inches	
	Min.	Max.	Min.	Max.
A	31.5	31.88	1.24	1.255
B	7.8	8.2	0.307	0.323
C	4.09	4.29	0.161	0.169
D	4.09	4.29	0.161	0.169
E	4.09	4.29	0.161	0.169
F	14.91	15.11	0.587	0.595
G	30.12	30.3	1.186	1.193
H	37.8	38.23	1.489	1.505
J	11.68	12.22	0.46	0.481
K	8.92	9.6	0.351	0.378
L	0.76	0.84	0.03	0.033
M	12.6	12.85	0.496	0.506
N	25.15	25.42	0.99	1.001
O	1.98	2.13	0.78	0.084
P	4.95	5.97	0.195	0.235
Q	26.54	26.9	1.045	1.059
R	3.94	4.42	0.155	0.174
S	4.72	4.85	0.186	0.191
T	24.59	25.07	0.968	0.987
U	-0.05	0.1	-0.002	0.004
V	3.3	4.57	0.13	0.18
W	19.81	21.08	0.78	0.83

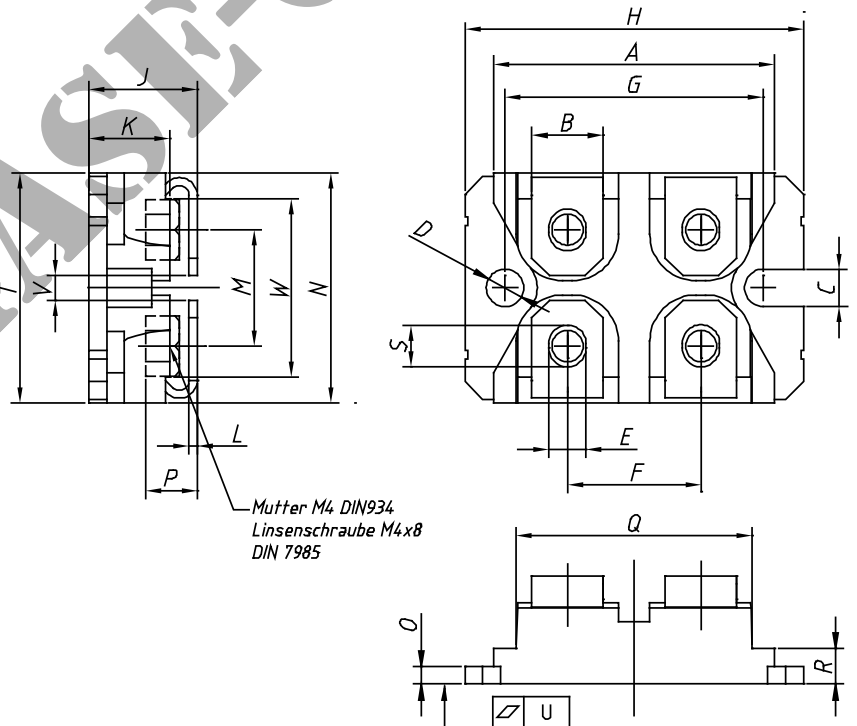

Product Marking

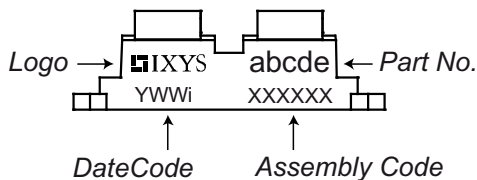

Ordering	Part Name	Marking on Product	Delivering Mode	Base Qty.	Code Key
Standard	IXUN350N10	IXUN350N10	Tube	10	501384

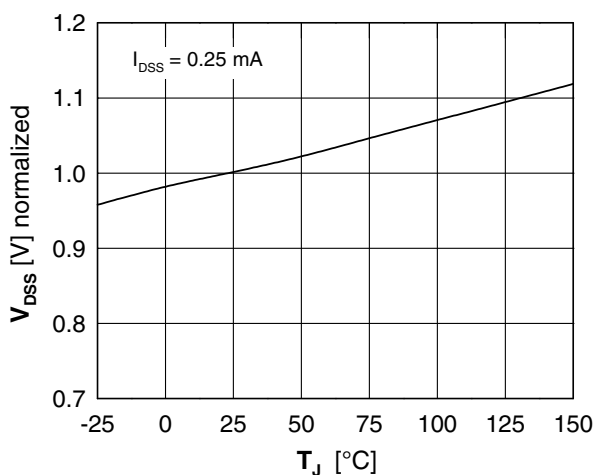

Fig. 1 Drain source breakdown voltage V_{DSS} vs. junction temperature T_J

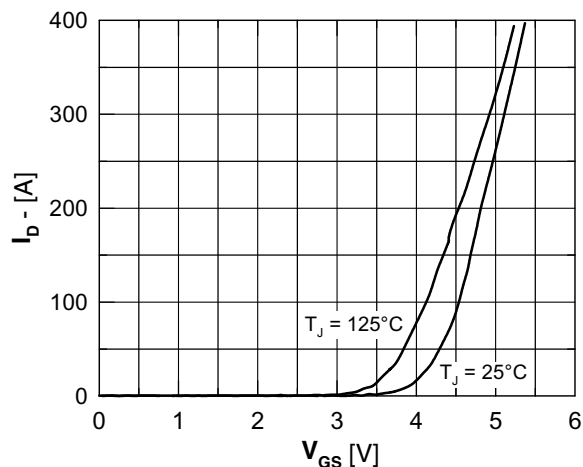

Fig. 2 Typical transfer characteristic

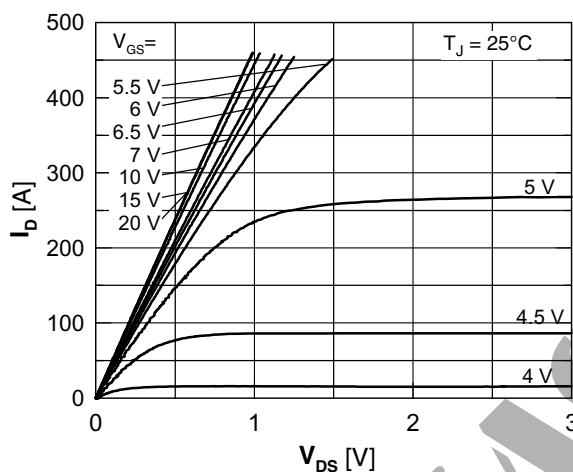

Fig. 3 Typical output characteristic

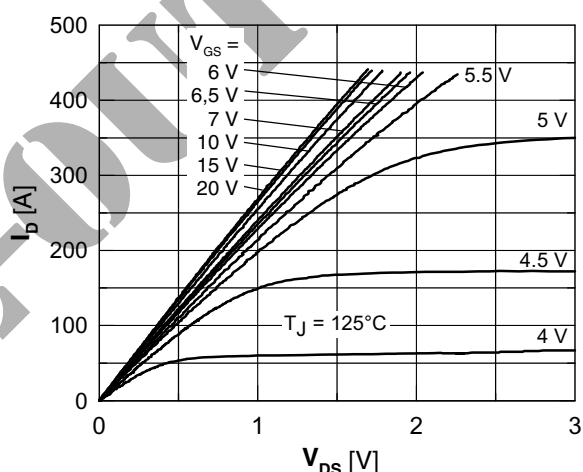

Fig. 4 Typical output characteristic

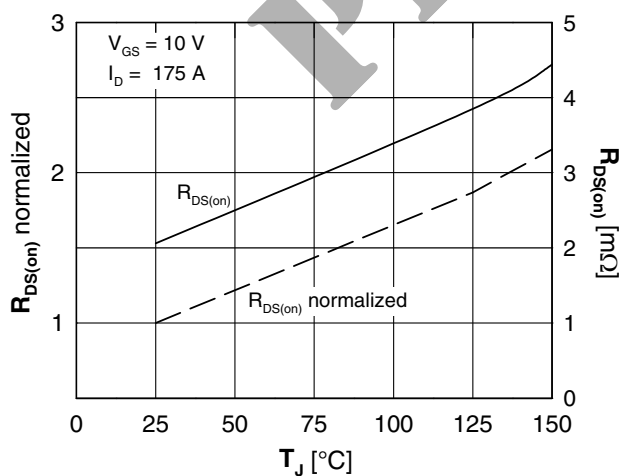

Fig. 5 Drain source on-state resistance $R_{DS(on)}$ versus junction temperature T_J

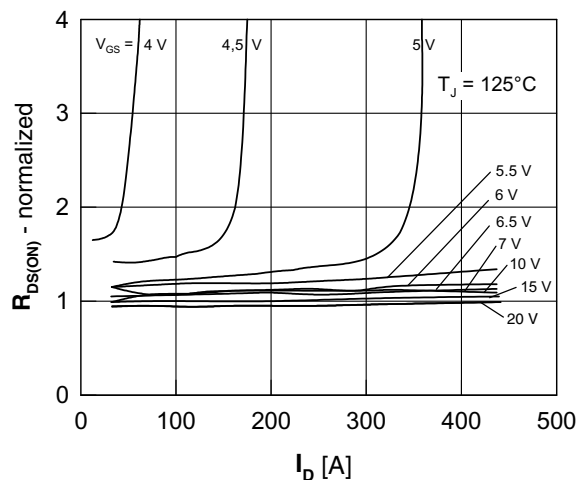

Fig. 6 Drain source on-state resistance $R_{DS(on)}$ versus I_D

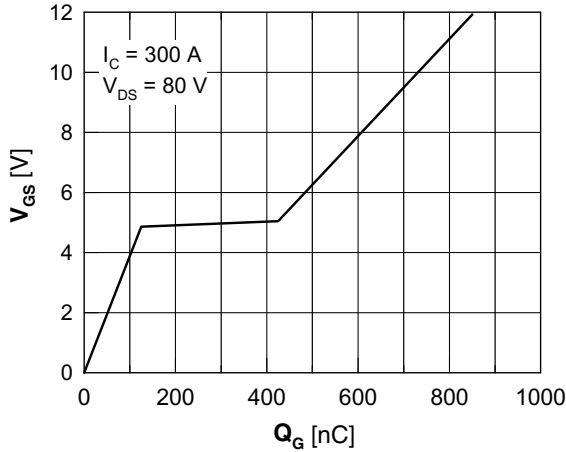

Fig. 7 Gate charge characteristic

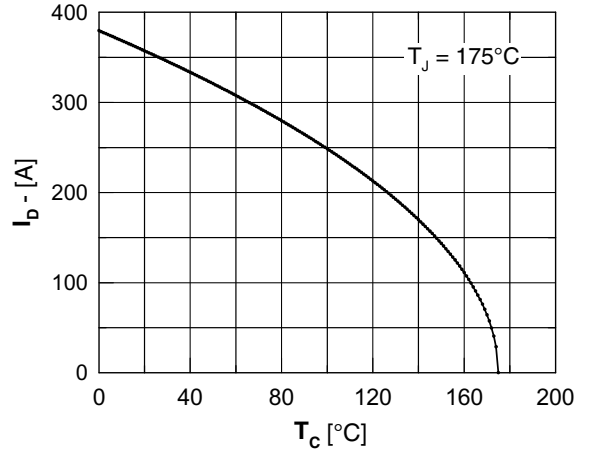

Fig. 8 Drain current I_D vs. case temperature T_C

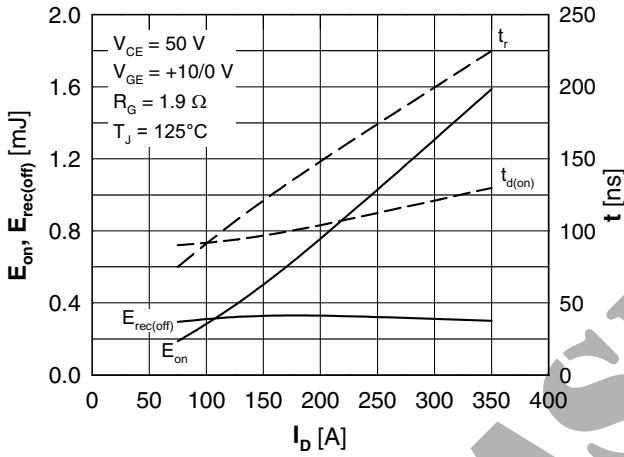

Fig. 9 Typ. turn-on energy & switching times vs. collector current, inductive switching

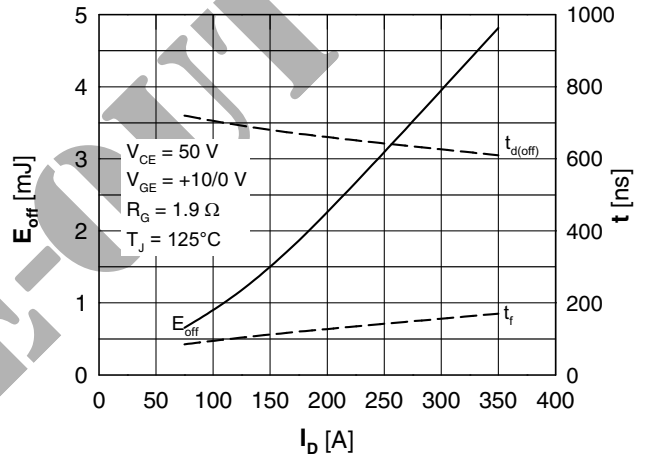

Fig. 10 Typ. turn-off energy & switching times vs. collector current, inductive switching

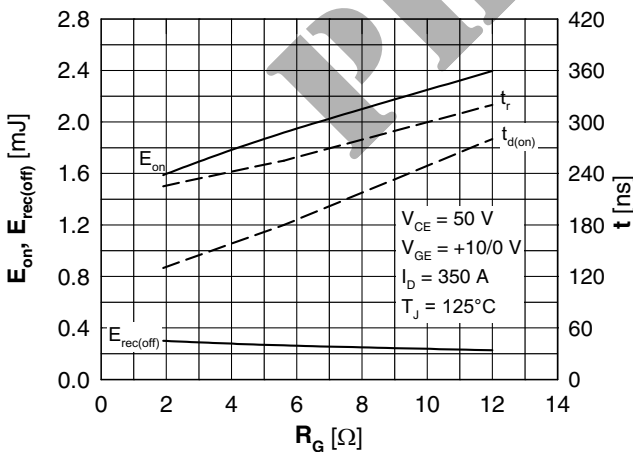

Fig. 11 Typ. turn-on energy & switching times vs. gate resistor, inductive switching

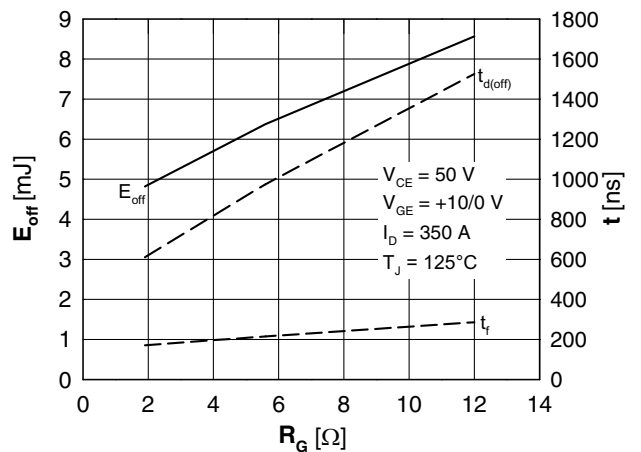

Fig. 12 Typ. turn-off energy & switching times vs. gate resistor, inductive switching

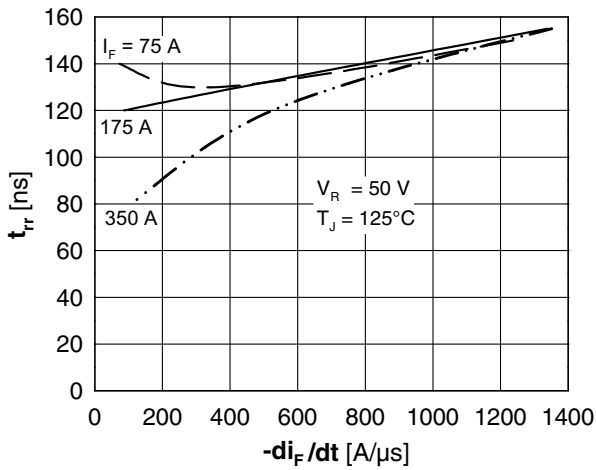

Fig. 13 Reverse recovery time t_{rr} of the body diode vs. di/dt

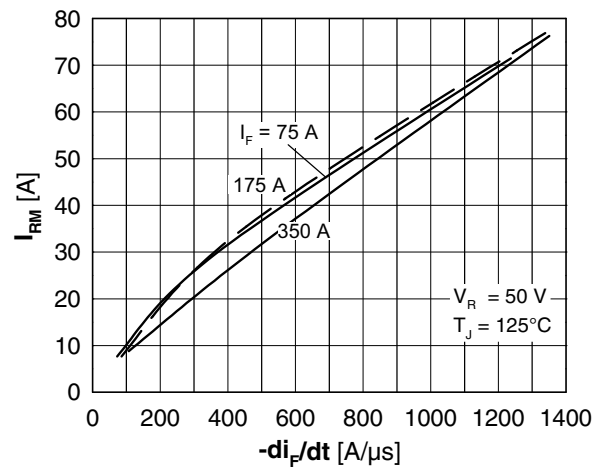

Fig. 14 Reverse recovery current I_{RM} of the body diode vs. di/dt

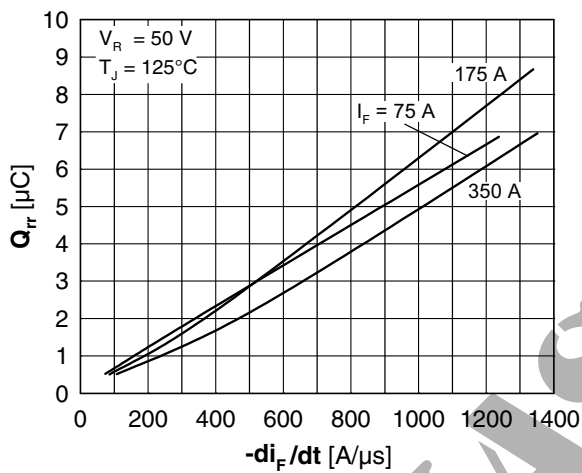

Fig. 15 Reverse recovery charge Q_{rr} of the body diode vs. di/dt

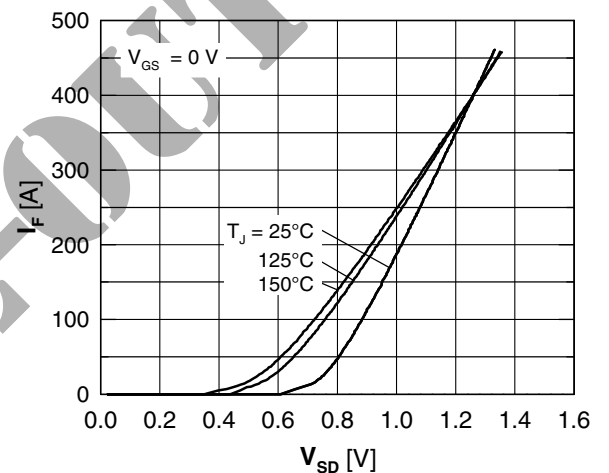

Fig. 16 Source drain diode current I_F vs. source drain voltage V_{SD} (body diode)

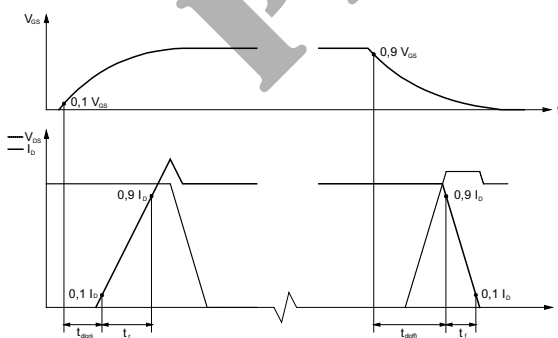

Fig. 17 Definition of switching times

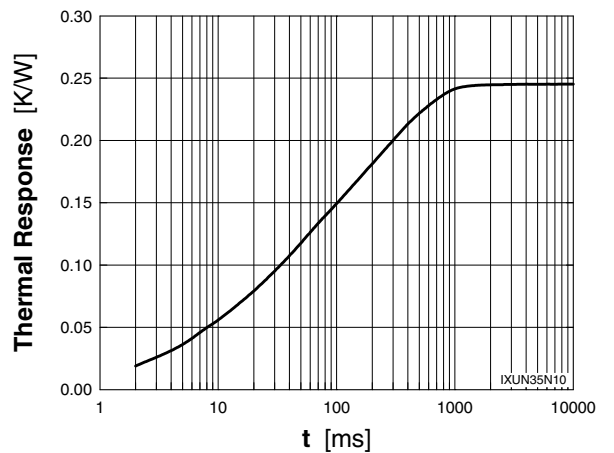

Fig. 18 Typ. thermal impedance junction to heatsink Z_{thJH} with heat transfer paste