



MICROCHIP TC4426AM/TC4427AM/TC4428AM

1.5A Dual High-Speed Power MOSFET Drivers

Features

- High Peak Output Current: 1.5A
- Wide Input Supply Voltage Operating Range:
 - 4.5V to 18V
- High Capacitive Load Drive Capability:
 - 1000 pF in 25 ns (typ.)
- Short Delay Times: 30 ns (typ.)
- Matched Rise, Fall and Delay Times
- Low Supply Current:
 - With Logic '1' Input – 1 mA (typ.)
 - With Logic '0' Input – 100 μ A (typ.)
- Low Output Impedance: 7 Ω (typ.)
- Latch-Up Protected: Will Withstand 0.5A Reverse Current
- Input: Will Withstand Negative Inputs Up to 5V
- ESD Protected: 4 kV
- Pin-compatible with the TC426M/TC427M/TC428M and TC4426M/TC4427M/TC4428M
- Wide Operating Temperature Range:
 - -55°C to +125°C
- See TC4426A/TC4427A/TC4428A Data Sheet (DS21423) for additional temperature range and packaging offerings

Applications

- Switch-mode Power Supplies
- Line Drivers
- Pulse Transformer Drive

General Description

The TC4426AM/TC4427AM/TC4428AM are improved versions of the earlier TC4426M/TC4427M/TC4428M family of MOSFET drivers. In addition to matched rise and fall times, the TC4426AM/TC4427AM/TC4428AM devices have matched leading and falling edge propagation delay times.

These devices are highly latch-up resistant under any conditions within their power and voltage ratings. They are not subject to damage when up to 5V of noise spiking (of either polarity) occurs on the ground pin. They can accept, without damage or logic upset, up to 500 mA of reverse current (of either polarity) being forced back into their outputs. All terminals are fully protected against Electrostatic Discharge (ESD) up to 4 kV.

The TC4426AM/TC4427AM/TC4428AM MOSFET drivers can easily charge/discharge 1000 pF gate capacitances in under 30 ns, while providing low enough impedances in both the on and off states to ensure the MOSFET's intended state will not be affected, even by large transients.

Package Types

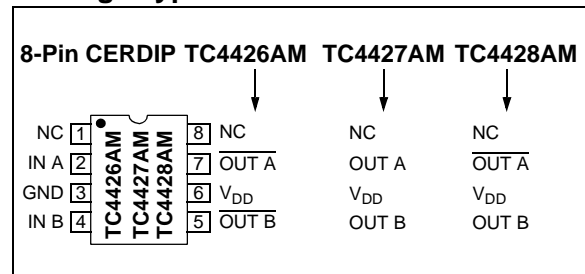

TC4426AM/TC4427AM/TC4428AM

Functional Block Diagram

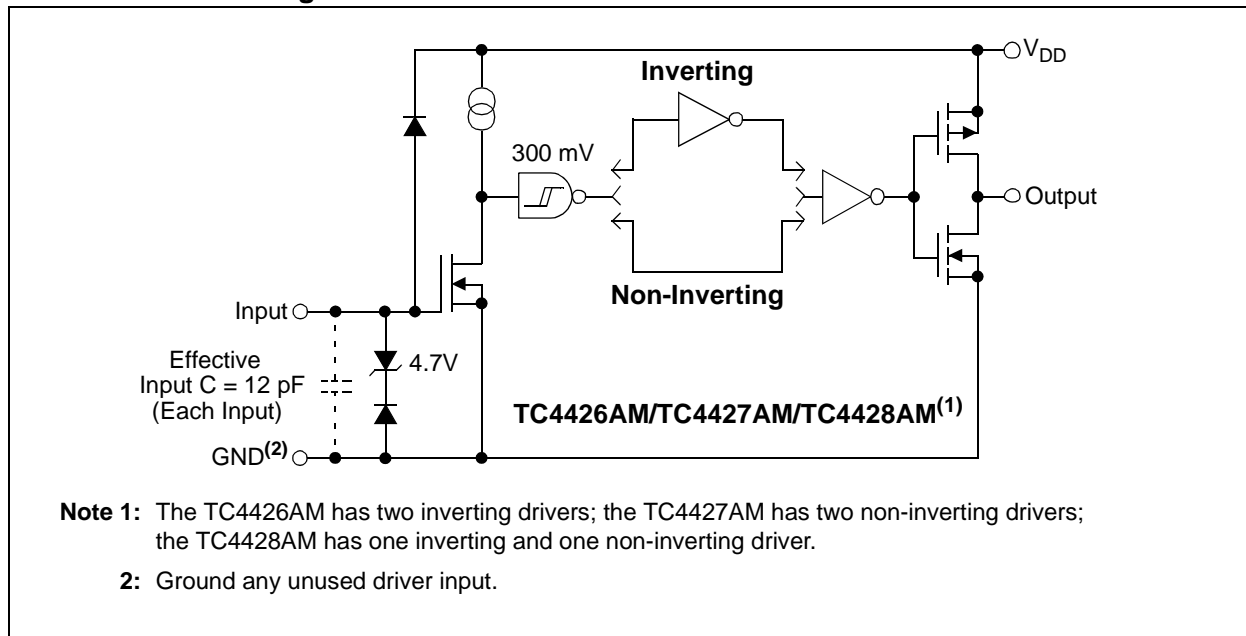

TC4426AM/TC4427AM/TC4428AM

1.0 ELECTRICAL CHARACTERISTICS

Absolute Maximum Ratings†

Supply Voltage+22V
 Input Voltage, IN A or IN B.....($V_{DD} + 0.3V$) to ($GND - 5V$)

† **Notice:** Stresses above those listed under "Absolute Maximum Ratings" may cause permanent damage to the device. These are stress ratings only and functional operation of the device at these or any other conditions above those indicated in the operation sections of the specifications is not implied. Exposure to Absolute Maximum Rating conditions for extended periods may affect device reliability.

DC CHARACTERISTICS

| Electrical Specifications: Unless otherwise noted, over operating temperature range with $4.5V \leq V_{DD} \leq 18V$. | | | | | | |
|--|-----------|------------------|------------|-------------|----------|--|
| Parameters | Sym | Min | Typ | Max | Units | Conditions |
| Input | | | | | | |
| Logic '1', High Input Voltage | V_{IH} | 2.4 | — | — | V | |
| Logic '0', Low Input Voltage | V_{IL} | — | — | 0.8 | V | |
| Input Current | I_{IN} | -1.0 -10 | — | +1.0 +10 | μA | $0V \leq V_{IN} \leq V_{DD}$ |
| Output | | | | | | |
| High Output Voltage | V_{OH} | $V_{DD} - 0.025$ | — | — | V | DC TEST |
| Low Output Voltage | V_{OL} | — | — | 0.025 | V | DC TEST |
| Output Resistance | R_O | — | 7 8 | 9 12 | Ω | $I_{OUT} = 10 \text{ mA}$, $V_{DD} = 18V$, $T_A = +25^\circ C$ $-55^\circ C \leq T_A \leq +125^\circ C$ |
| Peak Output Current | I_{PK} | — | 1.5 | — | A | $V_{DD} = 18V$ |
| Latch-Up Protection Withstand Reverse Current | I_{REV} | — | >0.5 | — | A | Duty cycle $\leq 2\%$, $t \leq 300 \mu s$ $V_{DD} = 18V$ |
| Switching Time (Note 1) | | | | | | |
| Rise Time | t_R | — | 25 30 | 35 40 | ns | $T_A = +25^\circ C$ $-55^\circ C \leq T_A \leq +125^\circ C$, Figure 4-1 |
| Fall Time | t_F | — | 25 30 | 35 40 | ns | $T_A = +25^\circ C$ $-55^\circ C \leq T_A \leq +125^\circ C$, Figure 4-1 |
| Delay Time | t_{D1} | — | 30 38 | 35 50 | ns | $T_A = +25^\circ C$ $-55^\circ C \leq T_A \leq +125^\circ C$, Figure 4-1 |
| Delay Time | t_{D2} | — | 30 38 | 35 50 | ns | $T_A = +25^\circ C$ $-55^\circ C \leq T_A \leq +125^\circ C$, Figure 4-1 |
| Power Supply | | | | | | |
| Power Supply Current | I_S | — | 1.0 0.1 | 2.0 0.2 | mA | $V_{IN} = 3V$ (Both inputs) $V_{IN} = 0V$ (Both inputs), $V_{DD} = 18V$ |

Note 1: Switching times ensured by design.

TEMPERATURE CHARACTERISTICS

| Electrical Specifications: Unless otherwise noted, all parameters apply with $4.5V \leq V_{DD} \leq 18V$. | | | | | | |
|--|---------------|-----|-----|------|--------------|------------|
| Parameters | Sym | Min | Typ | Max | Units | Conditions |
| Temperature Ranges | | | | | | |
| Specified Temperature Range (M) | T_A | -55 | — | +125 | $^\circ C$ | |
| Maximum Junction Temperature | T_J | — | — | +150 | $^\circ C$ | |
| Storage Temperature Range | T_A | -65 | — | +150 | $^\circ C$ | |
| Package Thermal Resistances | | | | | | |
| Thermal Resistance, 8L-CERDIP | θ_{JA} | — | 150 | — | $^\circ C/W$ | |

TC4426AM/TC4427AM/TC4428AM

2.0 TYPICAL PERFORMANCE CURVES

Note: The graphs and tables provided following this note are a statistical summary based on a limited number of samples and are provided for informational purposes only. The performance characteristics listed herein are not tested or guaranteed. In some graphs or tables, the data presented may be outside the specified operating range (e.g., outside specified power supply range) and therefore outside the warranted range.

Note: Unless otherwise indicated, over operating temperature range with $4.5V \leq V_{DD} \leq 18V$.

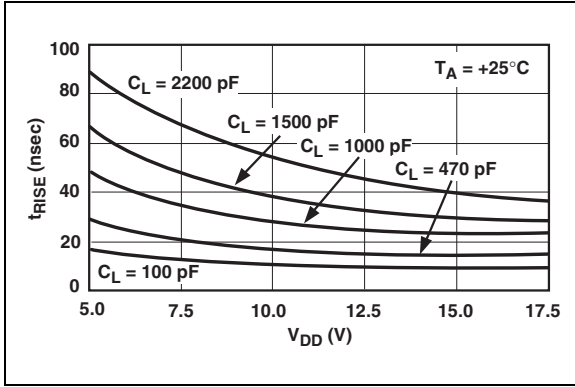

FIGURE 2-1: Rise Time vs. Supply Voltage.

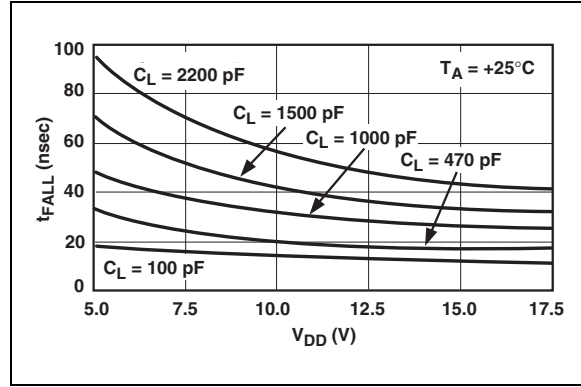

FIGURE 2-4: Fall Time vs. Supply Voltage.

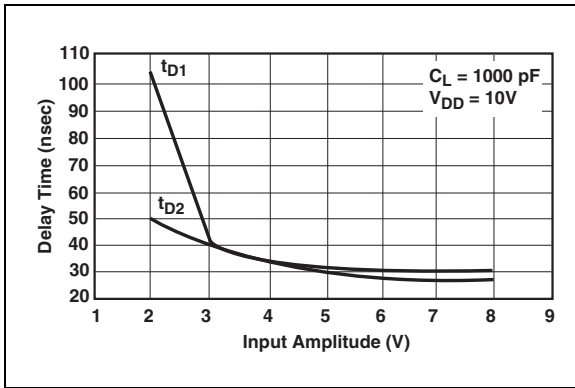

FIGURE 2-2: Delay Time vs. Input Amplitude.

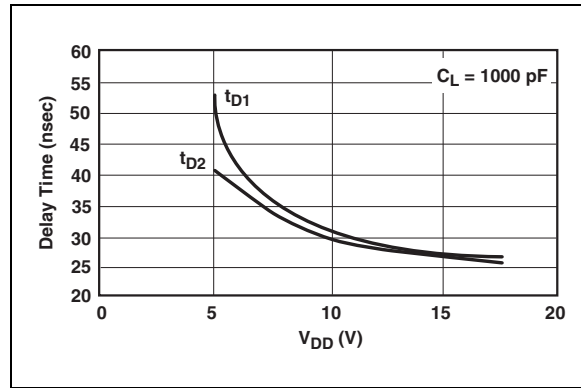

FIGURE 2-5: Propagation Delay Time vs. Supply Voltage.

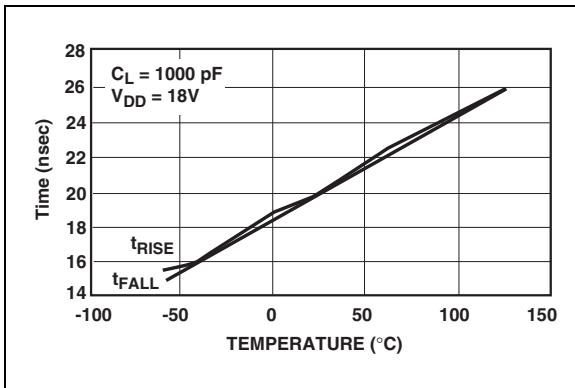

FIGURE 2-3: Rise and Fall Times vs. Temperature.

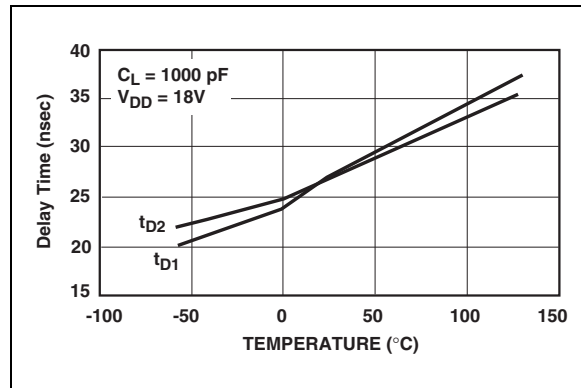

FIGURE 2-6: Propagation Delay Time vs. Temperature.

TC4426AM/TC4427AM/TC4428AM

Note: Unless otherwise indicated, over operating temperature range with $4.5V \leq V_{DD} \leq 18V$.

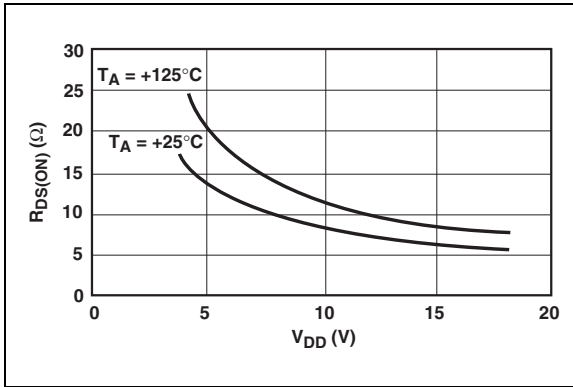

FIGURE 2-7: High-State Output Resistance.

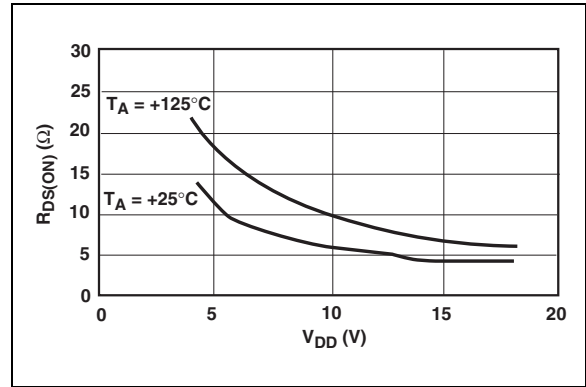

FIGURE 2-10: Low-State Output Resistance.

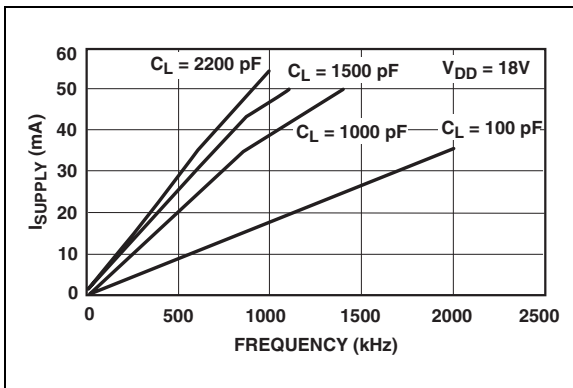

FIGURE 2-8: Supply Current vs. Frequency.

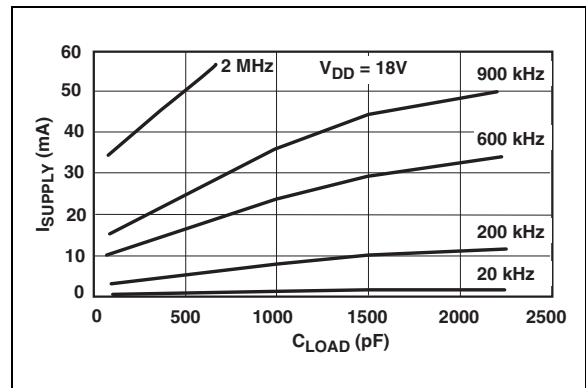

FIGURE 2-11: Supply Current vs. Capacitive Load.

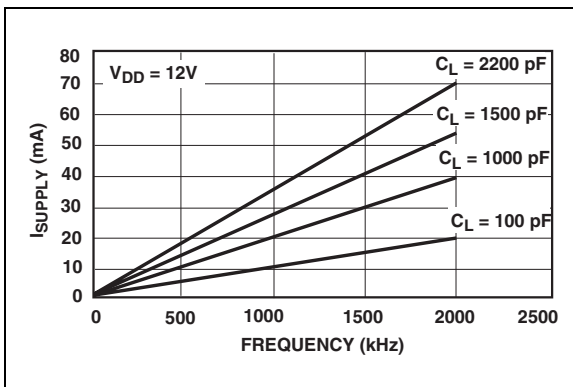

FIGURE 2-9: Supply Current vs. Frequency.

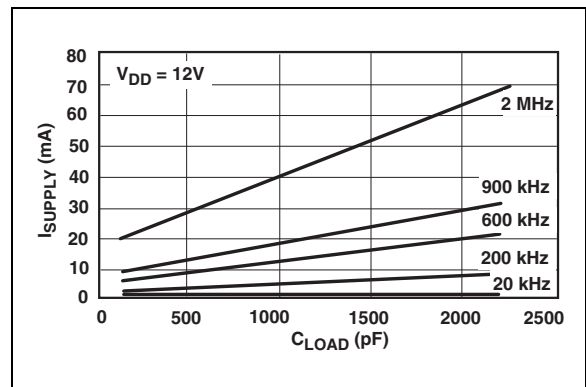

FIGURE 2-12: Supply Current vs. Capacitive Load.

TC4426AM/TC4427AM/TC4428AM

Note: Unless otherwise indicated, over operating temperature range with $4.5V \leq V_{DD} \leq 18V$.

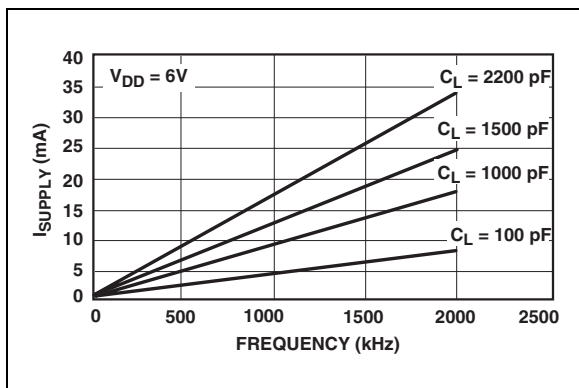

FIGURE 2-13: Supply Current vs. Frequency.

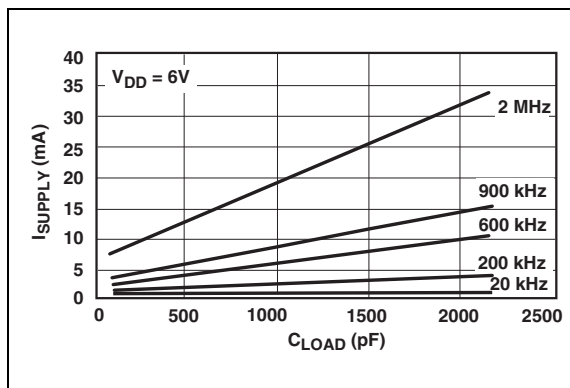

FIGURE 2-15: Supply Current vs. Capacitive Load.

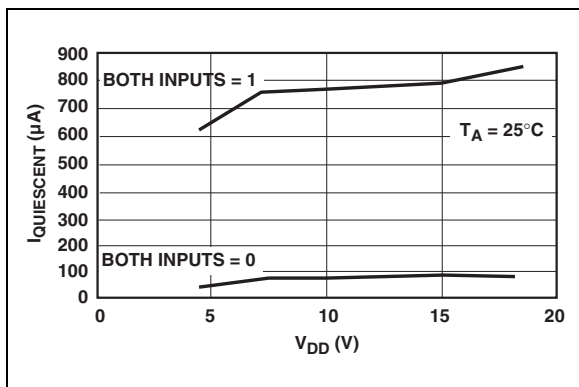

FIGURE 2-14: Quiescent Supply Current vs. Voltage.

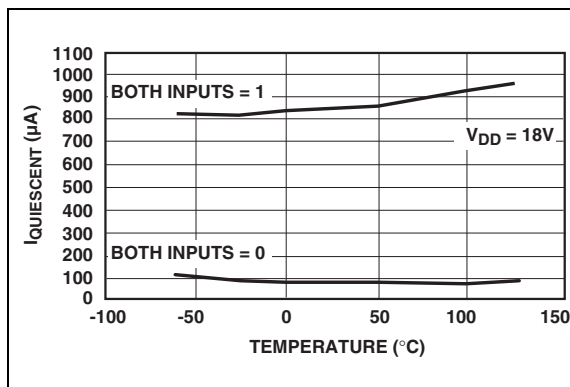

FIGURE 2-16: Quiescent Supply Current vs. Temperature.

TC4426AM/TC4427AM/TC4428AM

3.0 PIN DESCRIPTIONS

The descriptions of the pins are listed in Table 3-1.

TABLE 3-1: PIN FUNCTION TABLE

| 8-Pin Cerdip | Symbol | Description |
|--------------|-----------------|---------------|
| 1 | NC | No connection |
| 2 | IN A | Input A |
| 3 | GND | Ground |
| 4 | IN B | Input B |
| 5 | OUT B | Output B |
| 6 | V _{DD} | Supply input |
| 7 | OUT A | Output A |
| 8 | NC | No connection |

3.1 Inputs A & B (IN A and IN B)

MOSFET driver IN A & B are high-impedance, TTL/CMOS-compatible inputs. These inputs also have 300 mV of hysteresis between the high and low thresholds, which prevents output glitching even when the rise and fall time of the input signal is very slow.

3.2 Ground (GND)

The GND pin is the return path for both the bias current and the high peak current that discharges the external load capacitance. The ground pin should be tied into a ground plane or have a very short trace to the bias supply source return.

3.3 Outputs A & B (OUT A and OUT B)

MOSFET driver OUT A & B are low-impedance, CMOS, push-pull style outputs. The pull-down and pull-up devices are of equal strength, making the rise and fall times equivalent.

3.4 Supply Input (V_{DD})

The V_{DD} input is the bias supply for the MOSFET driver and is rated for 4.5V to 18V, with respect to the ground pin. The V_{DD} input should be bypassed with local ceramic capacitors. The value of these capacitors should be chosen based on the capacitive load that is being driven.

TC4426AM/TC4427AM/TC4428AM

4.0 APPLICATIONS INFORMATION

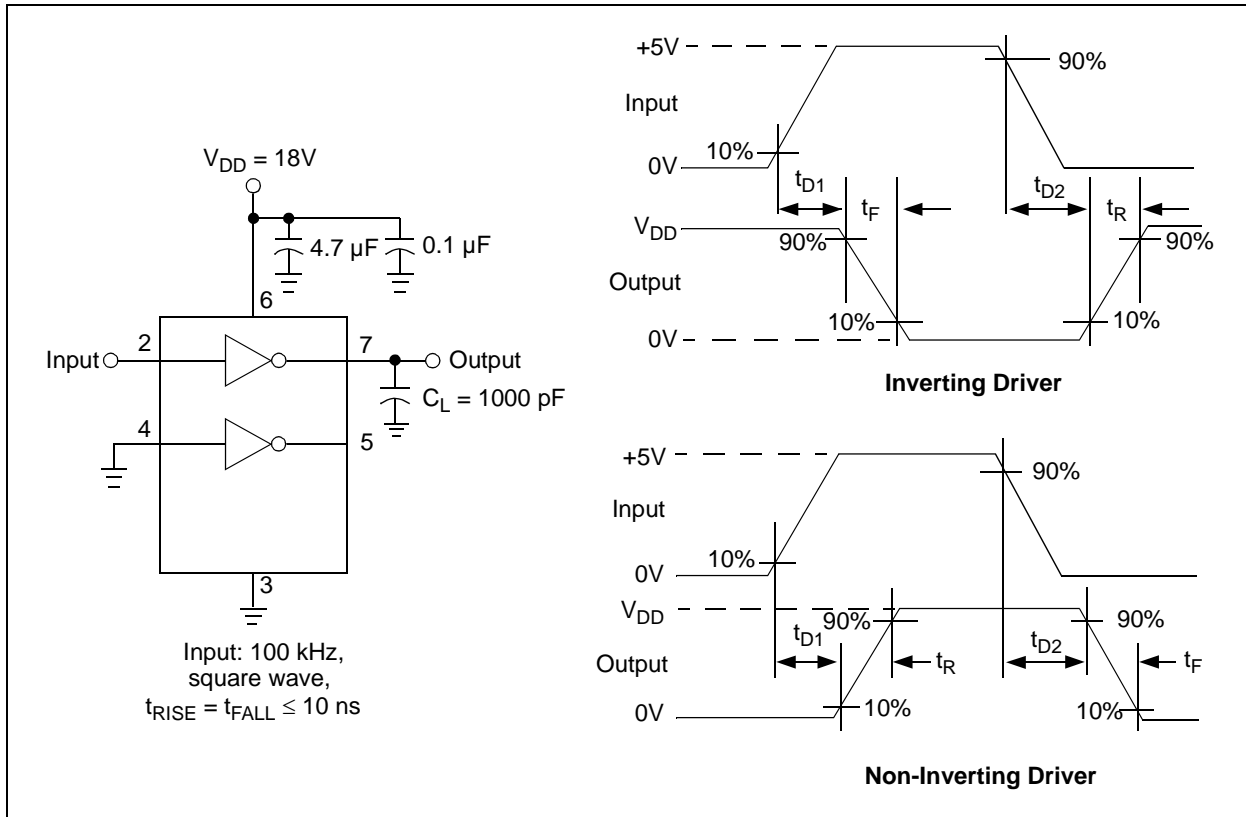

FIGURE 4-1: Switching Time Test Circuit.

TC4426AM/TC4427AM/TC4428AM

5.0 PACKAGING INFORMATION

5.1 Package Marking Information

8-Lead CERDIP (300 mil)

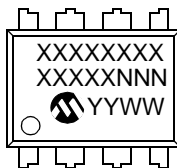

Example:

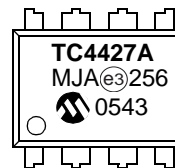

| | | |
|----------------|--------|--|
| Legend: | XX...X | Customer-specific information |
| | Y | Year code (last digit of calendar year) |
| | YY | Year code (last 2 digits of calendar year) |
| | WW | Week code (week of January 1 is week '01') |
| | NNN | Alphanumeric traceability code |
| | (e3) | Pb-free JEDEC designator for Matte Tin (Sn) |
| | * | This package is Pb-free. The Pb-free JEDEC designator (e3) can be found on the outer packaging for this package. |

Note: In the event the full Microchip part number cannot be marked on one line, it will be carried over to the next line, thus limiting the number of available characters for customer-specific information.

TC4426AM/TC4427AM/TC4428AM

8-Lead Ceramic Dual In-line – 300 mil (CERDIP)

Note: For the most current package drawings, please see the Microchip Packaging Specification located at <http://www.microchip.com/packaging>

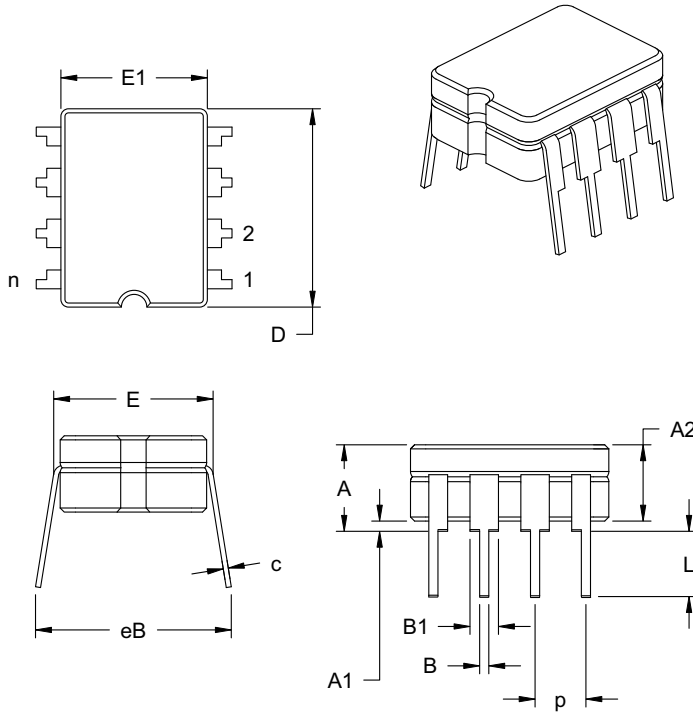

| Dimension Limits | Units | INCHES* | | | MILLIMETERS | | |
|----------------------------|-------|---------|------|------|-------------|------|-------|
| | | MIN | NOM | MAX | MIN | NOM | MAX |
| Number of Pins | n | | 8 | | | 8 | |
| Pitch | p | | .100 | | | 2.54 | |
| Top to Seating Plane | A | .160 | .180 | .200 | 4.06 | 4.57 | 5.08 |
| Standoff § | A1 | .020 | .030 | .040 | 0.51 | 0.77 | 1.02 |
| Shoulder to Shoulder Width | E | .290 | .305 | .320 | 7.37 | 7.75 | 8.13 |
| Ceramic Pkg. Width | E1 | .230 | .265 | .300 | 5.84 | 6.73 | 7.62 |
| Overall Length | D | .370 | .385 | .400 | 9.40 | 9.78 | 10.16 |
| Tip to Seating Plane | L | .125 | .163 | .200 | 3.18 | 4.13 | 5.08 |
| Lead Thickness | c | .008 | .012 | .015 | 0.20 | 0.29 | 0.38 |
| Upper Lead Width | B1 | .045 | .055 | .065 | 1.14 | 1.40 | 1.65 |
| Lower Lead Width | B | .016 | .018 | .020 | 0.41 | 0.46 | 0.51 |
| Overall Row Spacing | eB | .320 | .360 | .400 | 8.13 | 9.15 | 10.16 |

*Controlling Parameter

JEDEC Equivalent: MS-030

Drawing No. C04-010

APPENDIX A: REVISION HISTORY

Revision A (February 2005)

- Original Release of this Document.

Revision B (January 2013)

Added a note to each package outline drawing.

TC4426AM/TC4427AM/TC4428AM

NOTES:

TC4426AM/TC4427AM/TC4428AM

PRODUCT IDENTIFICATION SYSTEM

To order or obtain information, e.g., on pricing or delivery, refer to the factory or the listed sales office.

| <u>PART NO.</u> | <u>XX</u> |
|-------------------------------------|---|
| Device and Temperature Range | Package |
| Device and Temperature Range: | TC4426AM: 1.5A Dual MOSFET Driver, Inverting, -55°C to +125°C TC4427AM: 1.5A Dual MOSFET Driver, Non-Inverting, -55°C to +125°C TC4428AM: 1.5A Dual MOSFET Driver, Complementary, -55°C to +125°C |
| Package: | JA = Ceramic Dual In-line (300 mil Body), 8-lead |

Examples:

- a) TC4426AMJA: 1.5A Dual MOSFET driver, Inverting, -55°C to +125°C 8LD CERDIP package.
- a) TC4427AMJA: 1.5A Dual MOSFET driver, Non-Inverting -55°C to +125°C 8LD CERDIP package.
- a) TC4428AMJA: 1.5A Dual MOSFET driver, Complementary, -55°C to +125°C 8LD CERDIP package.

TC4426AM/TC4427AM/TC4428AM

NOTES:

Note the following details of the code protection feature on Microchip devices:

- Microchip products meet the specification contained in their particular Microchip Data Sheet.
- Microchip believes that its family of products is one of the most secure families of its kind on the market today, when used in the intended manner and under normal conditions.
- There are dishonest and possibly illegal methods used to breach the code protection feature. All of these methods, to our knowledge, require using the Microchip products in a manner outside the operating specifications contained in Microchip's Data Sheets. Most likely, the person doing so is engaged in theft of intellectual property.
- Microchip is willing to work with the customer who is concerned about the integrity of their code.
- Neither Microchip nor any other semiconductor manufacturer can guarantee the security of their code. Code protection does not mean that we are guaranteeing the product as “unbreakable.”

Code protection is constantly evolving. We at Microchip are committed to continuously improving the code protection features of our products. Attempts to break Microchip's code protection feature may be a violation of the Digital Millennium Copyright Act. If such acts allow unauthorized access to your software or other copyrighted work, you may have a right to sue for relief under that Act.

Information contained in this publication regarding device applications and the like is provided only for your convenience and may be superseded by updates. It is your responsibility to ensure that your application meets with your specifications. MICROCHIP MAKES NO REPRESENTATIONS OR WARRANTIES OF ANY KIND WHETHER EXPRESS OR IMPLIED, WRITTEN OR ORAL, STATUTORY OR OTHERWISE, RELATED TO THE INFORMATION, INCLUDING BUT NOT LIMITED TO ITS CONDITION, QUALITY, PERFORMANCE, MERCHANTABILITY OR FITNESS FOR PURPOSE. Microchip disclaims all liability arising from this information and its use. Use of Microchip devices in life support and/or safety applications is entirely at the buyer's risk, and the buyer agrees to defend, indemnify and hold harmless Microchip from any and all damages, claims, suits, or expenses resulting from such use. No licenses are conveyed, implicitly or otherwise, under any Microchip intellectual property rights.

Trademarks

The Microchip name and logo, the Microchip logo, dsPIC, FlashFlex, KEELOQ, KEELOQ logo, MPLAB, PIC, PICmicro, PICSTART, PIC³² logo, rPIC, SST, SST Logo, SuperFlash and UNI/O are registered trademarks of Microchip Technology Incorporated in the U.S.A. and other countries.

FilterLab, Hampshire, HI-TECH C, Linear Active Thermistor, MTP, SEEVAL and The Embedded Control Solutions Company are registered trademarks of Microchip Technology Incorporated in the U.S.A.

Silicon Storage Technology is a registered trademark of Microchip Technology Inc. in other countries.

Analog-for-the-Digital Age, Application Maestro, BodyCom, chipKIT, chipKIT logo, CodeGuard, dsPICDEM, dsPICDEM.net, dsPICworks, dsSPEAK, ECAN, ECONOMONITOR, FanSense, HI-TIDE, In-Circuit Serial Programming, ICSP, Mindi, MiWi, MPASM, MPF, MPLAB Certified logo, MPLIB, MPLINK, mTouch, Omniclient Code Generation, PICC, PICC-18, PICDEM, PICDEM.net, PICkit, PICTail, REAL ICE, rLAB, Select Mode, SQI, Serial Quad I/O, Total Endurance, TSHARC, UniWinDriver, WiperLock, ZENA and Z-Scale are trademarks of Microchip Technology Incorporated in the U.S.A. and other countries.

SQTP is a service mark of Microchip Technology Incorporated in the U.S.A.

GestIC and ULPP are registered trademarks of Microchip Technology Germany II GmbH & Co. & KG, a subsidiary of Microchip Technology Inc., in other countries.

All other trademarks mentioned herein are property of their respective companies.

© 2005-2013, Microchip Technology Incorporated, Printed in the U.S.A., All Rights Reserved.

 Printed on recycled paper.

ISBN: 9781620769201

QUALITY MANAGEMENT SYSTEM
CERTIFIED BY DNV
== ISO/TS 16949 ==

Microchip received ISO/TS-16949:2009 certification for its worldwide headquarters, design and wafer fabrication facilities in Chandler and Tempe, Arizona; Gresham, Oregon and design centers in California and India. The Company's quality system processes and procedures are for its PIC[®] MCUs and dsPIC[®] DSCs, KEELOQ[®] code hopping devices, Serial EEPROMs, microperipherals, nonvolatile memory and analog products. In addition, Microchip's quality system for the design and manufacture of development systems is ISO 9001:2000 certified.



MICROCHIP

Worldwide Sales and Service

AMERICAS

Corporate Office
2355 West Chandler Blvd.
Chandler, AZ 85224-6199
Tel: 480-792-7200
Fax: 480-792-7277
Technical Support:
<http://www.microchip.com/support>
Web Address:
www.microchip.com

Atlanta
Duluth, GA
Tel: 678-957-9614
Fax: 678-957-1455

Boston
Westborough, MA
Tel: 774-760-0087
Fax: 774-760-0088

Chicago
Itasca, IL
Tel: 630-285-0071
Fax: 630-285-0075

Cleveland
Independence, OH
Tel: 216-447-0464
Fax: 216-447-0643

Dallas
Addison, TX
Tel: 972-818-7423
Fax: 972-818-2924

Detroit
Farmington Hills, MI
Tel: 248-538-2250
Fax: 248-538-2260

Indianapolis
Noblesville, IN
Tel: 317-773-8323
Fax: 317-773-5453

Los Angeles
Mission Viejo, CA
Tel: 949-462-9523
Fax: 949-462-9608

Santa Clara
Santa Clara, CA
Tel: 408-961-6444
Fax: 408-961-6445

Toronto
Mississauga, Ontario,
Canada
Tel: 905-673-0699
Fax: 905-673-6509

ASIA/PACIFIC

Asia Pacific Office
Suites 3707-14, 37th Floor
Tower 6, The Gateway
Harbour City, Kowloon
Hong Kong
Tel: 852-2401-1200
Fax: 852-2401-3431

Australia - Sydney
Tel: 61-2-9868-6733
Fax: 61-2-9868-6755

China - Beijing
Tel: 86-10-8569-7000
Fax: 86-10-8528-2104

China - Chengdu
Tel: 86-28-8665-5511
Fax: 86-28-8665-7889

China - Chongqing
Tel: 86-23-8980-9588
Fax: 86-23-8980-9500

China - Hangzhou
Tel: 86-571-2819-3187
Fax: 86-571-2819-3189

China - Hong Kong SAR
Tel: 852-2943-5100
Fax: 852-2401-3431

China - Nanjing
Tel: 86-25-8473-2460
Fax: 86-25-8473-2470

China - Qingdao
Tel: 86-532-8502-7355
Fax: 86-532-8502-7205

China - Shanghai
Tel: 86-21-5407-5533
Fax: 86-21-5407-5066

China - Shenyang
Tel: 86-24-2334-2829
Fax: 86-24-2334-2393

China - Shenzhen
Tel: 86-755-8864-2200
Fax: 86-755-8203-1760

China - Wuhan
Tel: 86-27-5980-5300
Fax: 86-27-5980-5118

China - Xian
Tel: 86-29-8833-7252
Fax: 86-29-8833-7256

China - Xiamen
Tel: 86-592-2388138
Fax: 86-592-2388130

China - Zhuhai
Tel: 86-756-3210040
Fax: 86-756-3210049

ASIA/PACIFIC

India - Bangalore
Tel: 91-80-3090-4444
Fax: 91-80-3090-4123

India - New Delhi
Tel: 91-11-4160-8631
Fax: 91-11-4160-8632

India - Pune
Tel: 91-20-2566-1512
Fax: 91-20-2566-1513

Japan - Osaka
Tel: 81-6-6152-7160
Fax: 81-6-6152-9310

Japan - Tokyo
Tel: 81-3-6880-3770
Fax: 81-3-6880-3771

Korea - Daegu
Tel: 82-53-744-4301
Fax: 82-53-744-4302

Korea - Seoul
Tel: 82-2-554-7200
Fax: 82-2-558-5932 or
82-2-558-5934

Malaysia - Kuala Lumpur
Tel: 60-3-6201-9857
Fax: 60-3-6201-9859

Malaysia - Penang
Tel: 60-4-227-8870
Fax: 60-4-227-4068

Philippines - Manila
Tel: 63-2-634-9065
Fax: 63-2-634-9069

Singapore
Tel: 65-6334-8870
Fax: 65-6334-8850

Taiwan - Hsin Chu
Tel: 886-3-5778-366
Fax: 886-3-5770-955

Taiwan - Kaohsiung
Tel: 886-7-213-7828
Fax: 886-7-330-9305

Taiwan - Taipei
Tel: 886-2-2508-8600
Fax: 886-2-2508-0102

Thailand - Bangkok
Tel: 66-2-694-1351
Fax: 66-2-694-1350

EUROPE

Austria - Wels
Tel: 43-7242-2244-39
Fax: 43-7242-2244-393

Denmark - Copenhagen
Tel: 45-4450-2828
Fax: 45-4485-2829

France - Paris
Tel: 33-1-69-53-63-20
Fax: 33-1-69-30-90-79

Germany - Munich
Tel: 49-89-627-144-0
Fax: 49-89-627-144-44

Italy - Milan
Tel: 39-0331-742611
Fax: 39-0331-466781

Netherlands - Drunen
Tel: 31-416-690399
Fax: 31-416-690340

Spain - Madrid
Tel: 34-91-708-08-90
Fax: 34-91-708-08-91

UK - Wokingham
Tel: 44-118-921-5869
Fax: 44-118-921-5820

11/29/12