

## GenX3™ 300V IGBT

## IXGK400N30A3

## IXGX400N30A3\*

\*Obsolete Part Number

Ultra-low V<sub>sat</sub> PT IGBTs for up to 10kHz switching

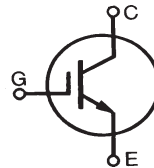

$$V_{CES} = 300V$$

$$I_{C25} = 400A$$

$$V_{CE(sat)} \leq 1.15V$$

Symbol	Test Conditions	Maximum Ratings	
$V_{CES}$	$T_J = 25^\circ C$ to $150^\circ C$	300	V
$V_{CGR}$	$T_J = 25^\circ C$ to $150^\circ C$ , $R_{GE} = 1M\Omega$	300	V
$V_{GES}$	Continuous	$\pm 20$	V
$V_{GEM}$	Transient	$\pm 30$	V
$I_{C25}$	$T_C = 25^\circ C$	400	A
$I_{C110}$	$T_C = 110^\circ C$	200	A
$I_{LRMS}$	Terminal Current Limit	75	A
$I_{CM}$	$T_C = 25^\circ C$ , 1ms	400	A
<b>SSOA</b>	$V_{GE} = 15V$ , $T_{VJ} = 125^\circ C$ , $R_G = 1\Omega$	$I_{CM} = 400$	A
<b>(RBSOA)</b>	Clamped inductive load	@ $0.8 \cdot V_{CES}$	
$P_C$	$T_C = 25^\circ C$	1000	W
$T_J$		-55 ... +150	$^\circ C$
$T_{JM}$		150	$^\circ C$
$T_{stg}$		-55 ... +150	$^\circ C$
$T_L$	Maximum lead temperature for soldering	300	$^\circ C$
$T_{SOLD}$	1.6 mm (0.062 in.) from case for 10	260	$^\circ C$
$M_d$	Mounting torque ( IXGK )	1.13/10	Nm/lb.in.
$F_c$	Mounting force ( IXGX )	20..120/4.5..27	N/lb.
<b>Weight</b>	TO-264	10	g
	PLUS247	6	g

TO-264

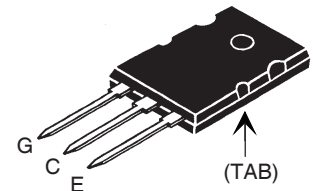

PLUS247™

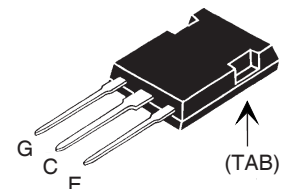

G = Gate                      E = Emitter  
C = Collector                TAB = Collector

### Features

- Optimized for low switching losses
- Square RBSOA
- High avalanche capability
- International standard packages

### Advantages

- High power density
- Low gate drive requirement

### Applications

- Power Inverters
- UPS
- Motor Drives
- SMPS
- PFC Circuits
- Battery Chargers
- Welding Machines
- Lamp Ballasts
- Inrush Current Protection Circuits

Symbol	Test Conditions ( $T_J = 25^\circ C$ , unless otherwise specified)	Characteristic Values		
		Min.	Typ.	Max.
$BV_{CES}$	$I_C = 1mA$ , $V_{GE} = 0V$	300		V
$V_{GE(th)}$	$I_C = 4mA$ , $V_{CE} = V_{GE}$	3.0		5.0 V
$I_{CES}$	$V_{CE} = V_{CES}$ $V_{GE} = 0V$ $T_J = 125^\circ C$			50 $\mu A$ 2 mA
$I_{GES}$	$V_{CE} = 0V$ , $V_{GE} = \pm 20V$			$\pm 400$ nA
$V_{CE(sat)}$	$I_C = 100A$ , $V_{GE} = 15V$ , Note 1 $I_C = 400A$	1.70	1.15	V V

Symbol	Test Conditions	Characteristic Values		
		Min.	Typ.	Max.
$g_{fs}$	$I_C = 60A, V_{CE} = 10V, \text{Note 1}$	100	170	S
$C_{ies}$	$V_{CE} = 25V, V_{GE} = 0V, f = 1 \text{ MHz}$		19	nF
$C_{oes}$			1350	pF
$C_{res}$			190	pF
$Q_{g(on)}$	$I_C = 100A, V_{GE} = 15V, V_{CE} = 0.5 \cdot V_{CES}$		560	nC
$Q_{ge}$			83	nC
$Q_{gc}$			185	nC
$t_{d(on)}$	<b>Resistive load, <math>T_J = 25^\circ\text{C}</math></b> $I_C = 100A, V_{GE} = 15V$ $V_{CE} = 240V, R_G = 1\Omega$		45	ns
$t_r$			45	ns
$t_{d(off)}$			210	ns
$t_f$			107	ns
$t_{d(on)}$		<b>Resistive load, <math>T_J = 125^\circ\text{C}</math></b> $I_C = 100A, V_{GE} = 15V$ $V_{CE} = 240V, R_G = 1\Omega$		47
$t_r$			53	ns
$t_{d(off)}$			240	ns
$t_f$			315	ns
$R_{thJC}$				0.125
$R_{thCK}$		0.15		$^\circ\text{C/W}$

### TO-264 (IXGK) Outline

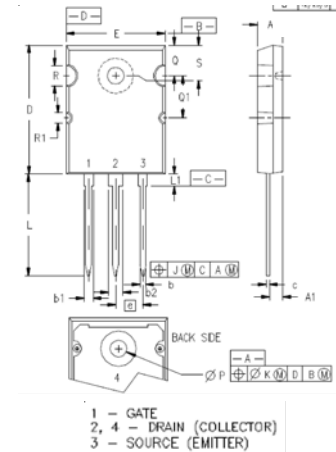

SYM	INCHES		MILLIMETERS	
	MIN	MAX	MIN	MAX
A	.185	.209	4.70	5.31
A1	.102	.118	2.59	3.00
b	.037	.055	0.94	1.40
b1	.087	.102	2.21	2.59
b2	.110	.126	2.79	3.20
c	.017	.029	0.43	0.74
D	1.007	1.047	25.58	26.59
E	.760	.789	19.30	20.29
e	.215BSC		5.46 BSC	
J	.000	.010	0.00	0.25
K	.000	.010	0.00	0.25
L	.779	.842	19.79	21.39
L1	.087	.102	2.21	2.59
ØP	.122	.138	3.10	3.51
Q	.240	.256	6.10	6.50
Q1	.330	.346	8.38	8.79
ØR	.155	.187	3.94	4.75
ØR1	.085	.093	2.16	2.36
S	.243	.253	6.17	6.43

Note: 1. Pulse test,  $t \leq 300\mu\text{s}$ ; duty cycle,  $d \leq 2\%$ .

### PLUS247™ (IXGX) Outline

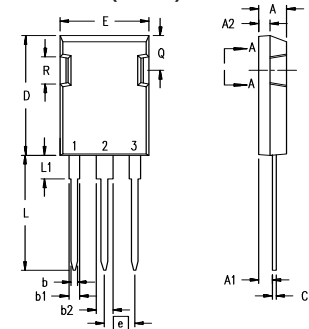

Terminals: 1 - Gate  
2 - Drain (Collector)  
3 - Source (Emitter)

Dim.	Millimeter		Inches	
	Min.	Max.	Min.	Max.
A	4.83	5.21	.190	.205
A <sub>1</sub>	2.29	2.54	.090	.100
A <sub>2</sub>	1.91	2.16	.075	.085
b	1.14	1.40	.045	.055
b <sub>1</sub>	1.91	2.13	.075	.084
b <sub>2</sub>	2.92	3.12	.115	.123
C	0.61	0.80	.024	.031
D	20.80	21.34	.819	.840
E	15.75	16.13	.620	.635
e	5.45 BSC		.215 BSC	
L	19.81	20.32	.780	.800
L1	3.81	4.32	.150	.170
Q	5.59	6.20	.220	0.244
R	4.32	4.83	.170	.190

IXYS reserves the right to change limits, test conditions, and dimensions.

IXYS MOSFETs and IGBTs are covered by one or more of the following U.S. patents:

4,835,592	4,931,844	5,049,961	5,237,481	6,162,665	6,404,065 B1	6,683,344	6,727,585	7,005,734 B2	7,157,338B2
4,850,072	5,017,508	5,063,307	5,381,025	6,259,123 B1	6,534,343	6,710,405 B2	6,759,692	7,063,975 B2	
4,881,106	5,034,796	5,187,117	5,486,715	6,306,728 B1	6,583,505	6,710,463	6,771,478 B2	7,071,537	

**Fig. 1. Output Characteristics @ 25°C**

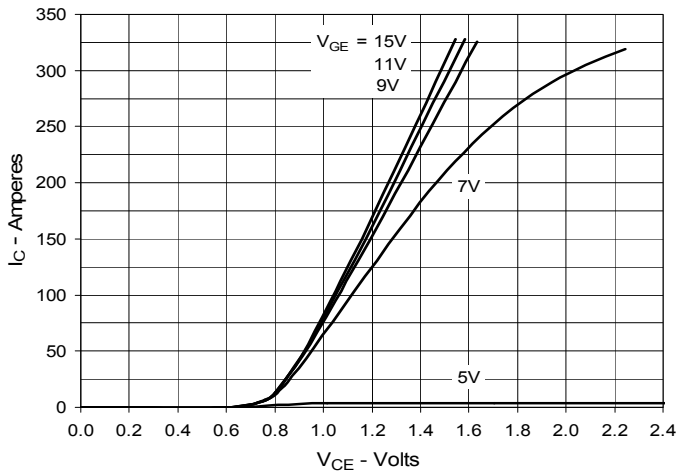

**Fig. 2. Output Characteristics @ 125°C**

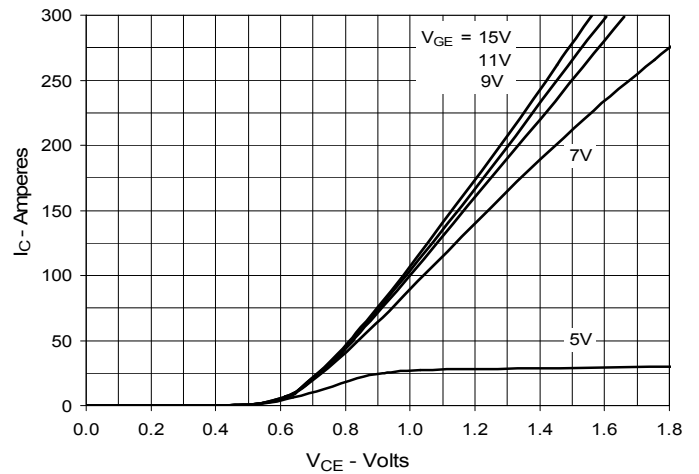

**Fig. 3. Dependence of  $V_{CE(sat)}$  on Junction Temperature**

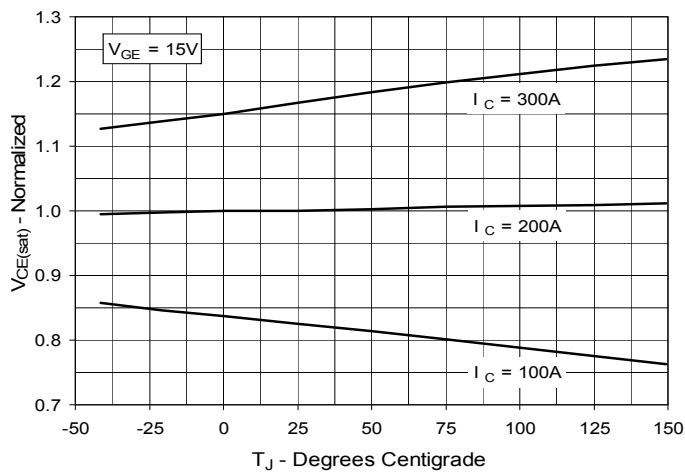

**Fig. 4. Collector-to-Emitter Voltage vs. Gate-to-Emitter Voltage**

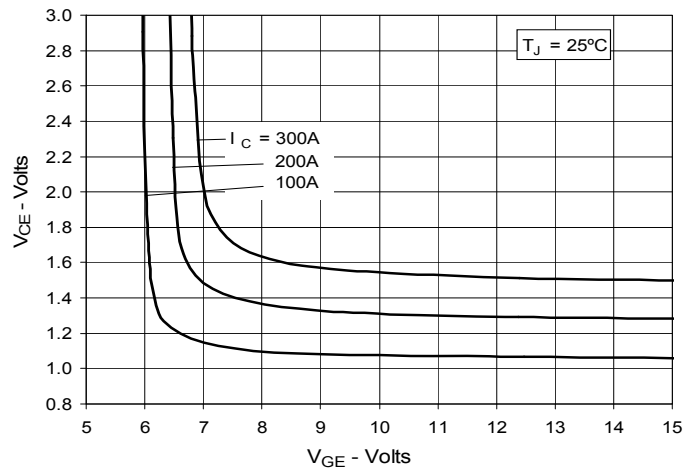

**Fig. 5. Input Admittance**

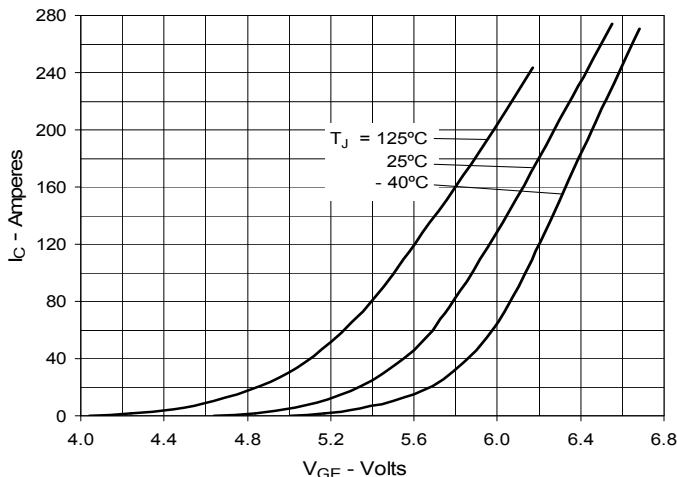

**Fig. 6. Transconductance**

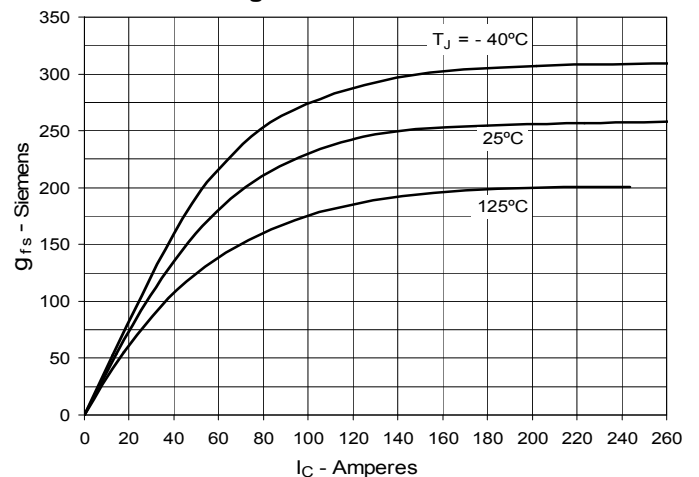

**Fig. 7. Gate Charge**

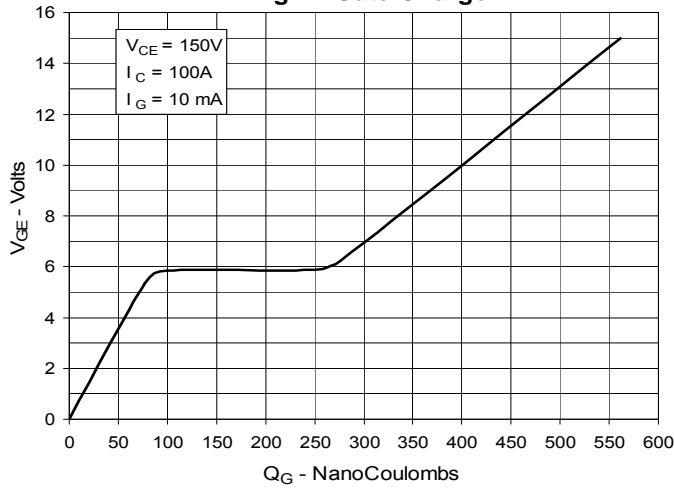

**Fig. 8. Capacitance**

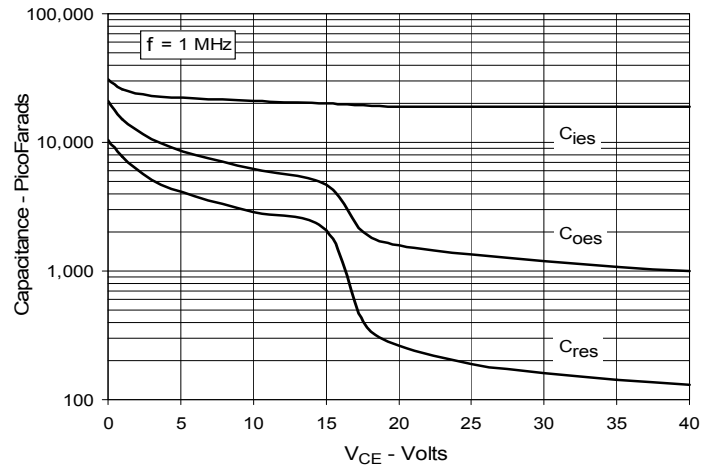

**Fig. 9. Reverse-Bias Safe Operating Area**

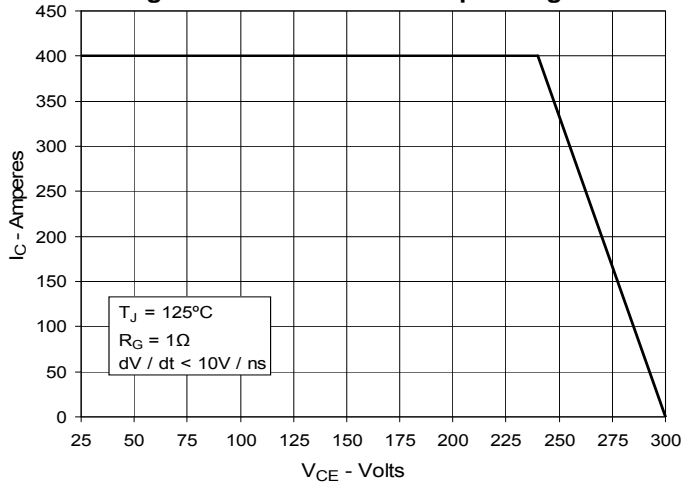

**Fig. 10. Maximum Transient Thermal Impedance**

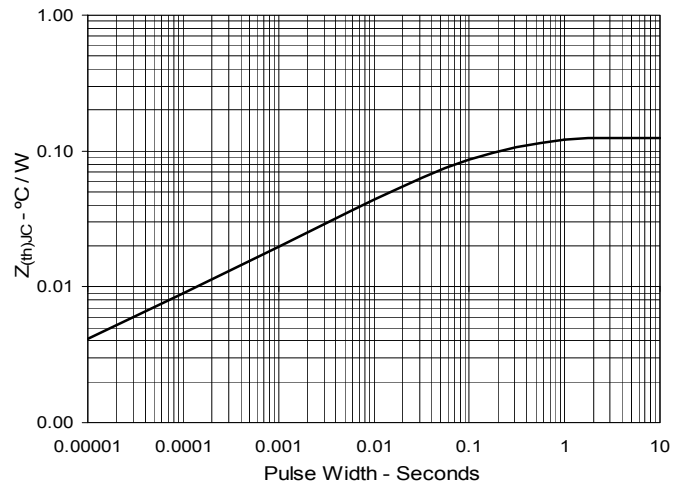

**Fig. 11. Resistive Turn-on Rise Time vs. Junction Temperature**

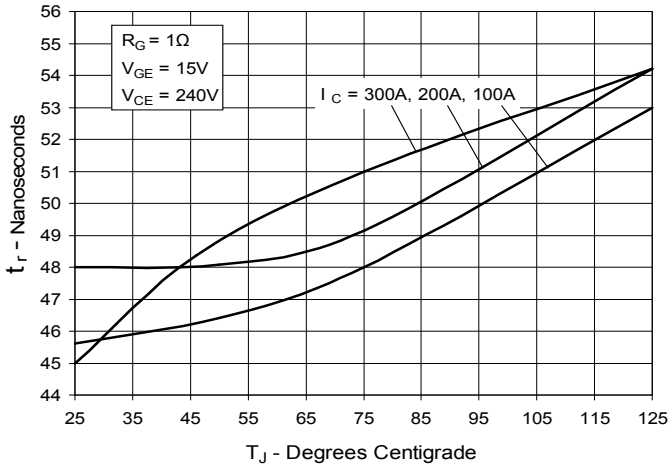

**Fig. 12. Resistive Turn-on Rise Time vs. Collector Current**

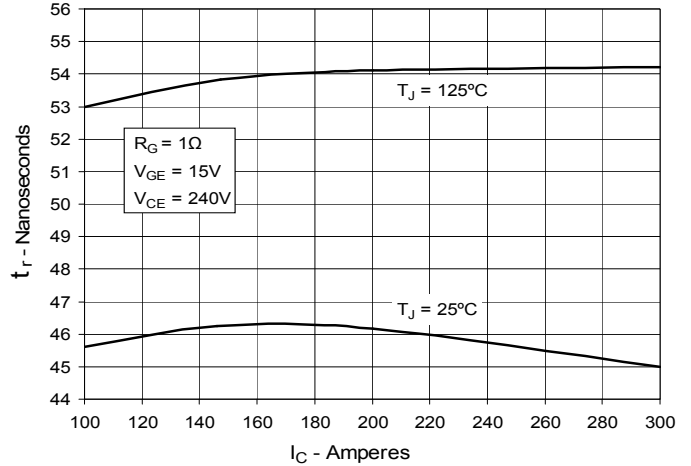

**Fig. 13. Resistive Turn-on Switching Times vs. Gate Resistance**

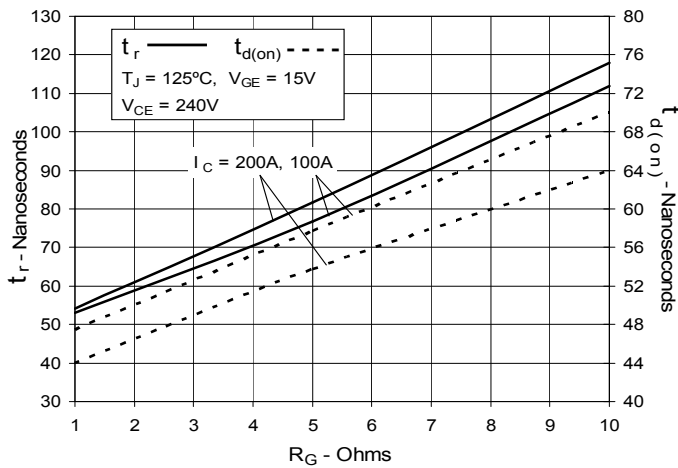

**Fig. 14. Resistive Turn-off Switching Times vs. Junction Temperature**

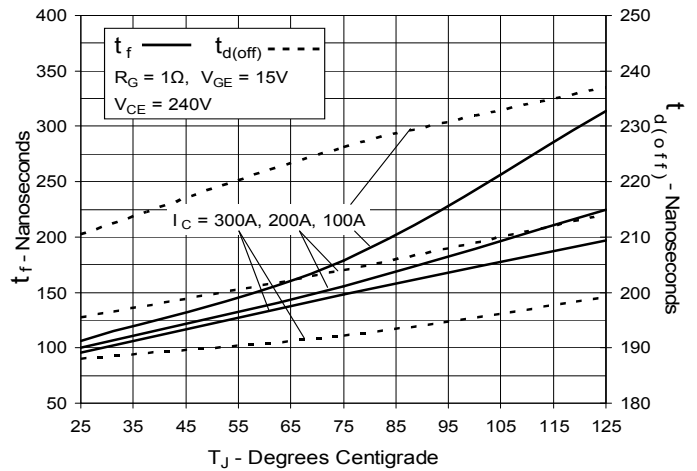

**Fig. 15. Resistive Turn-off Switching Times vs. Gate Resistance**

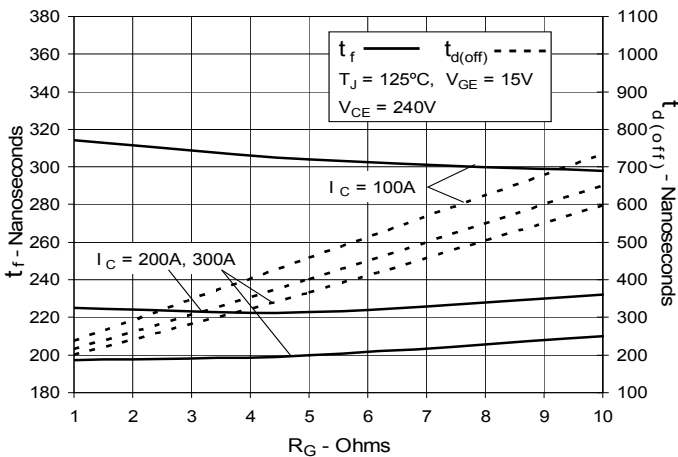

**Fig. 16. Resistive Turn-off Switching Times vs. Collector Current**

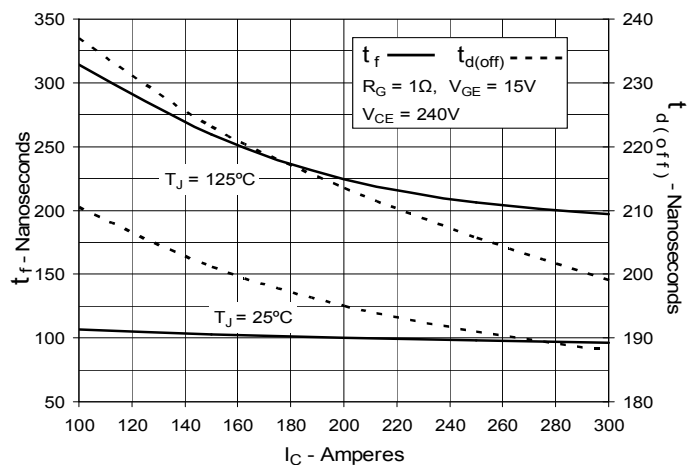



---

Disclaimer Notice - Information furnished is believed to be accurate and reliable. However, users should independently evaluate the suitability of and test each product selected for their own applications. Littelfuse products are not designed for, and may not be used in, all applications. Read complete Disclaimer Notice at [www.littelfuse.com/disclaimer-electronics](http://www.littelfuse.com/disclaimer-electronics).