



SPECIFICATION SHEET

SPECIFICATION SHEET NO.	N0729-TO220ABMBRF100
DATE	July 29, 2021
REVISION	A0
DESCRIPTION	Thru Hole Schottky Barrier Rectifier, TO-220AB Series, MBRF20100CT Type, 3 Pins, Reverse Voltage 100V Max. Forward Current 20.0A Max. Operating Temp. Range -55°C ~+150°C, Package in Bulk, 1000pcs/Box RoHS/RoHS III compliant
CUSTOMER	
CUSTOMER PART NUMBER	
CROSS REF. PART NUMBER	
ORIGINAL PART NUMBER	MDD MBRF20100CT
PART CODE	TO220ABMBRF100

VENDOR APPROVE			
Issued/Checked/Approved			
DATE: July 29, 2021			

CUSTOMER APPROVE	
DATE:	

THRU HOLE SCHOTTKY BARRIER RECTIFIER TO-220AB SERIES

MAIN FEATURE



- The plastic package carries Underwriters Laboratory Flammability Classification 94V-0
- Construction utilizes void-free
- Low reverse leakage
- High forward surge current capability
- High temperature soldering guaranteed: 250 °C, 0.25” (6.35mm) from case for 10 seconds

APPLICATION

- For printed circuit board

[RFQ](#)
[Request For Quotation](#)

PART CODE GUIDE

TO220AB	MBMRF100
1	2

1) **TO220AB**: Thru hole Schottky Barrier Rectifier, TO-220AB Series code

2) **MBMFRF100**: Type Code for original part number MBRF20100CT, Reverse Voltage 100V Max. Forward Current 20.0A Max.

MORE ITEMS AVAILABLE

TO220ABMBRF020	TO220ABMBRF030	TO220ABMBRF040	TO220ABMBRF045	TO220ABMBRF050
TO220ABMBRF060	TO220ABMBRF070	TO220ABMBRF080	TO220ABMBRF090	TO220ABMBRF100
TO220ABMBRF150	TO220ABMBRF200			

THRU HOLE SCHOTTKY BARRIER RECTIFIER TO-220AB SERIES

DIMENSION (Unit: Inch/mm)

Image for reference



Marking:

MBRF
20100CT

TO-220AB

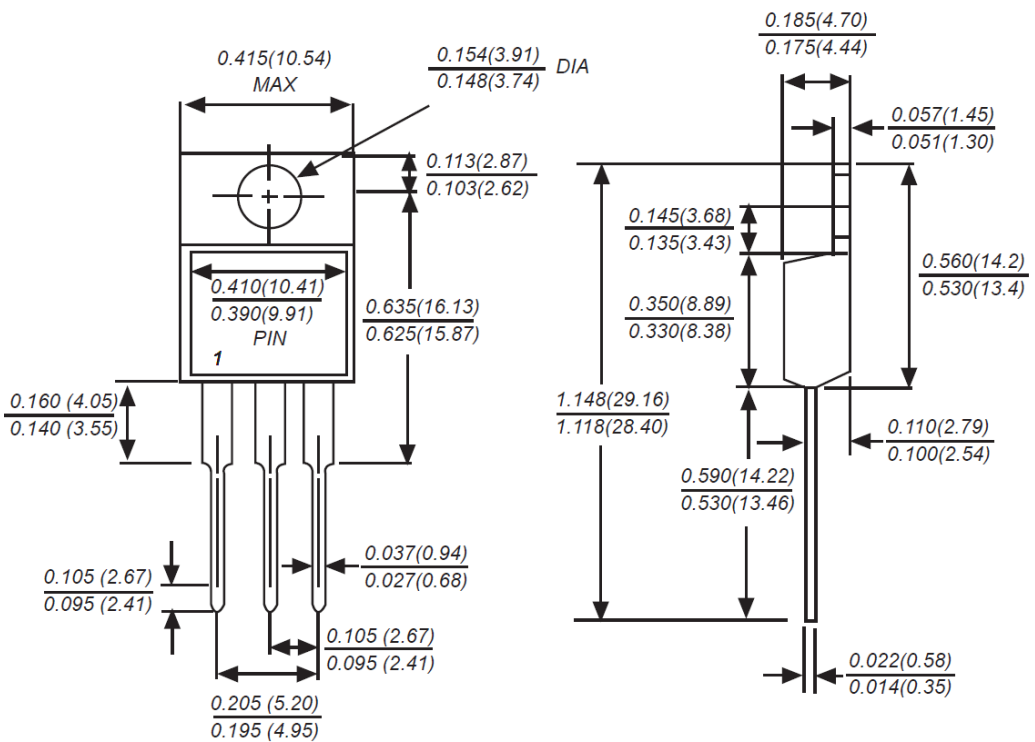

Recommend Pad Layout

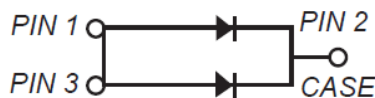

THRU HOLE SCHOTTKY BARRIER RECTIFIER TO-220AB SERIES
MECHANICAL DATA

Case	Terminals	Polarity	Mounting Position	Weight per piece
JEDEC TO-220AB molded plastic body	Solder plated, Solderable per MIL-STD-750, Method 2026	Polarity symbol marking on case	Any	0.080 Ounce, 2.24 grams

MAX. RATING & CHARACTERISTICS

Parameter	SYMBOLS	VALUE			UNITS
		Min.	Typical	Max.	
Repetitive peak reverse voltage	V _{RRM}			100	Volts
RMS voltage	V _{RMS}			70	Volts
DC blocking voltage	V _{DC}			100	Volts
Average forward output rectified current at TL= 110°C	I _{AV}			20.0	A
Peak forward surge current 8.3ms single half sine-wave superimposed on rated load (JEDEC Method)	I _{FSM}		150		A
Instantaneous forward voltage at 10.0A	V _F			0.85	Volts
DC reverse current at rated DC blocking voltage	I _R	TA=25°C		1.0	mA
		TA=100°C		50.0	
Junction capacitance (Note 2)	C _J		450		pF
Thermal resistance (Note 3)	R _{QJA}		2.0		°C/W
Operating junction temperature range	T _J	-55		+150	°C
Storage temperature range	T _{STG}	-55		+150	°C

Note

1. Ratings at 25 C ambient temperature unless otherwise specified. Single phase half-wave 60Hz, resistive or inductive load, for capacitive load current derate by 20%.
2. Measured at 1.0MHz and applied reverse voltage of 4.0Voltage
3. Thermal resistance from junction to case

THRU HOLE SCHOTTKY BARRIER RECTIFIER TO-220AB SERIES
RELIABILITY

Number	Experiment Items	Experiment Method And Conditions	Reference Documents
1	Solder Resistance Test	Test 260°C± 5°C for 10 ± 2 sec. Immerse body into solder 1/16" ± 1/32"	MIL-STD-750D METHOD-2031.2
2	Solderability Test	230°C ±5°C for 5 sec.	MIL-STD-750D METHOD-2026.1 0
3	Pull Test	1 kg in axial lead direction for 10 sec.	MIL-STD-750D METHOD-2036.4
4	Bend Test	0.5Kg Weight Applied To Each Lead, Bending Arcs 90 °C ± 5 °C For 3 Times	MIL-STD-750D METHOD-2036.4
5	High Temperature Reverse Bias Test	TA=100°C for 1000 Hours at VR=80% Rated VR	MIL-STD-750D METHOD-1038.4
6	Forward Operation Life Test	TA=25°C Rated Average Rectified Current	MIL-STD-750D METHOD-1027.3
7	Intermittent Operation Life Test	On state: 5 min with rated IRMS Power Off state: 5 min with Cool Forced Air. On and off for 1000 cycles.	MIL-STD-750D METHOD-1036.3
8	Pressure Cooker Test	15 PSIG, TA=121°C, 4 hours	MIL-S-19500 APPENOIXC
9	Temperature Cycling Test	-55°C~+125°C; 30 Minutes For Dwelled Time 5 minutes for transferred time. Total: 10 cycles.	MIL-STD-750D METHOD-1051.7
10	Thermal Shock Test	0°C for 5 minutes., 100°C for 5minutes, Total: 10 cycles	MIL-STD-750D METHOD-1056.7
11	Forward Surge Test	8.3ms Single Sale Sine-wave One Surge.	MIL-STD-750D METHOD-4066.4
12	Humidity Test	TA=65°C, RH=98% for 1000 hours.	MIL-STD-750D METHOD-1021.3
13	High Temperature Storage life Test	150°C for 1000 Hours	MIL-STD-750D METHOD-1031.5

THRU HOLE SCHOTTKY BARRIER RECTIFIER TO-220AB SERIES

RATINGS AND CHARACTERISTIC CURVES (For Reference Only)

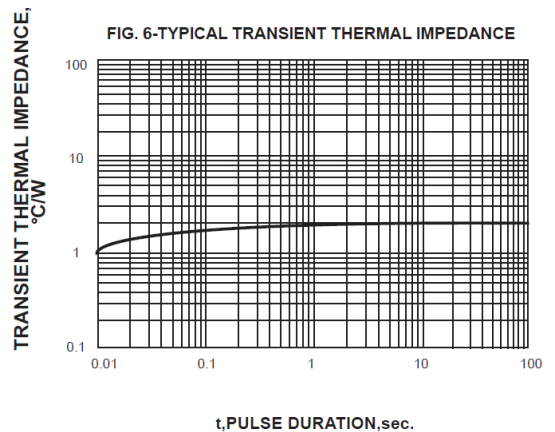
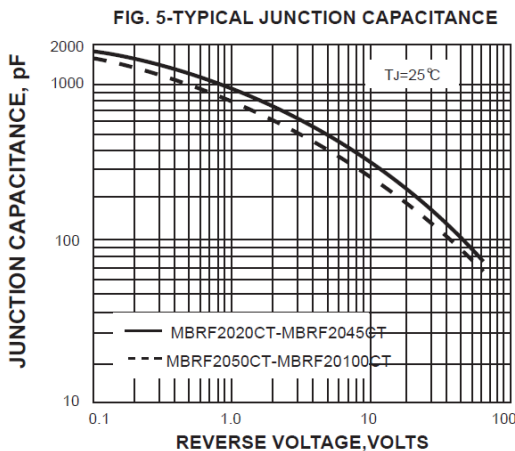
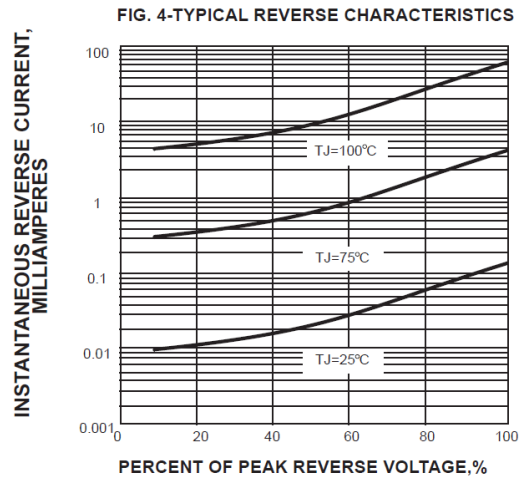
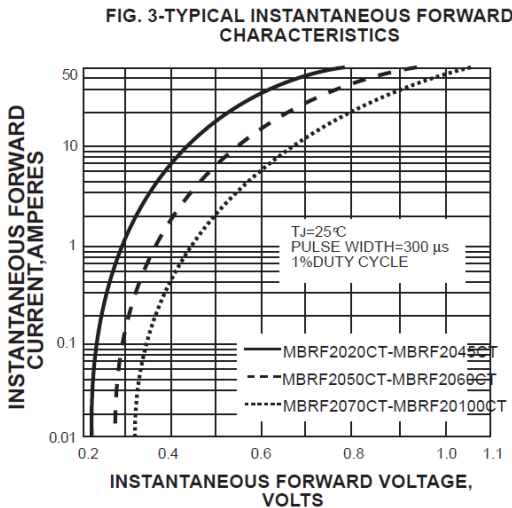
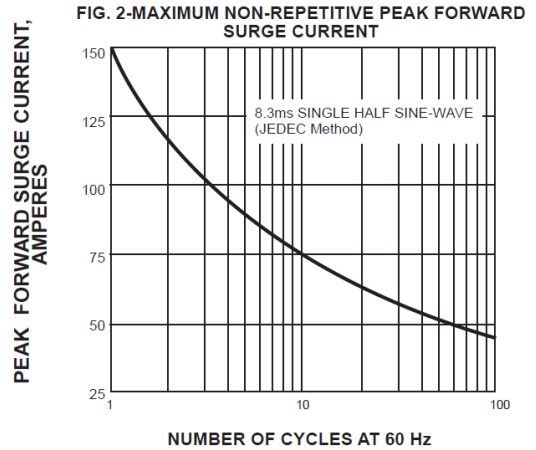
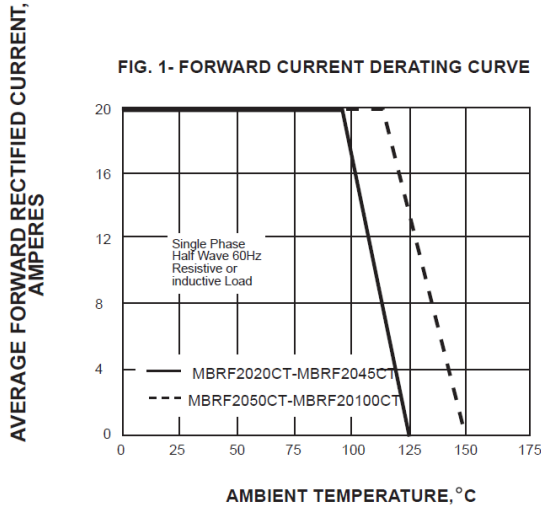

THRU HOLE SCHOTTKY BARRIER RECTIFIER TO-220AB SERIES

PACKAGE

Case Code	Box	MPQ (pcs)	Component Spacing (mm)	Qty. Per Box (pcs)	Inner Box L*W*H (mm)	Reel Size (mm)	Carton size L*W*H (mm)	Qty. Per Carton (pcs)	G. W (kg)
TO-220AB		1,000		1,000	560*155*40	2.65	580*220*180	5,000	14.0

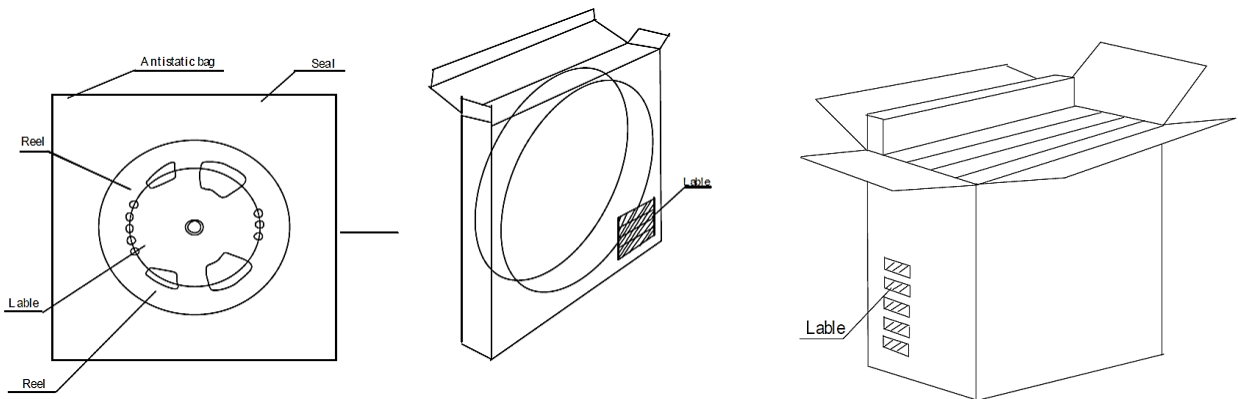

DISCLAIMER

NextGen Component, Inc. reserves the right to make changes to the product(s) and or information contained herein without notice. No liability is assumed as a result of their use or application. No rights under any patent accompany the sale of any such product(s) or information