

Product Specification for Approval

WE ARE PLEASED IN SUBMITTING OUR SAMPLES WITH SPECIFICATION TO YOU FOR APPROVAL.

CUSTOMER	:		
DESCRIPTION	:	10/100 BASE-T TRANSFORMER	
MNC P/N	:	H1605DG	
VERSION	:	A0	
CUSTOMER P/N	:		
ISSUED DATE	:	2020/04/27	
PHOTO OF PRODUCT	:		
WEIGHT	:		1.50g
MADE IN	:		CHINA

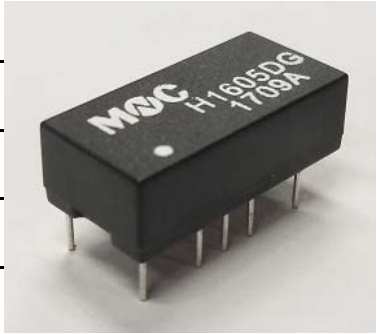
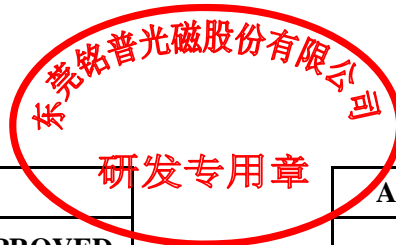

APPROVED BY MNC			APPROVED BY CUSTOMER
PREPARED BY 	CHECKED BY 	APPROVED BY 	SIGNATURE OR STAMP

1. PLEASE SEND BACK US A COPY OF THE SPECIFICATION WITH YOUR STAMP OR SIGNATURE ONCE THE SAMPLES APPROVED.
2. IT WILL BE DEEMED THE SAMPLES TO BE APPROVED IF NO FEEDBACK.

东莞铭普光磁股份有限公司
 Add: Shipai Town, Dongguan City, Guangdong Province, China

TEL: +86-769-86921000
 FAX: +86-769-81701563

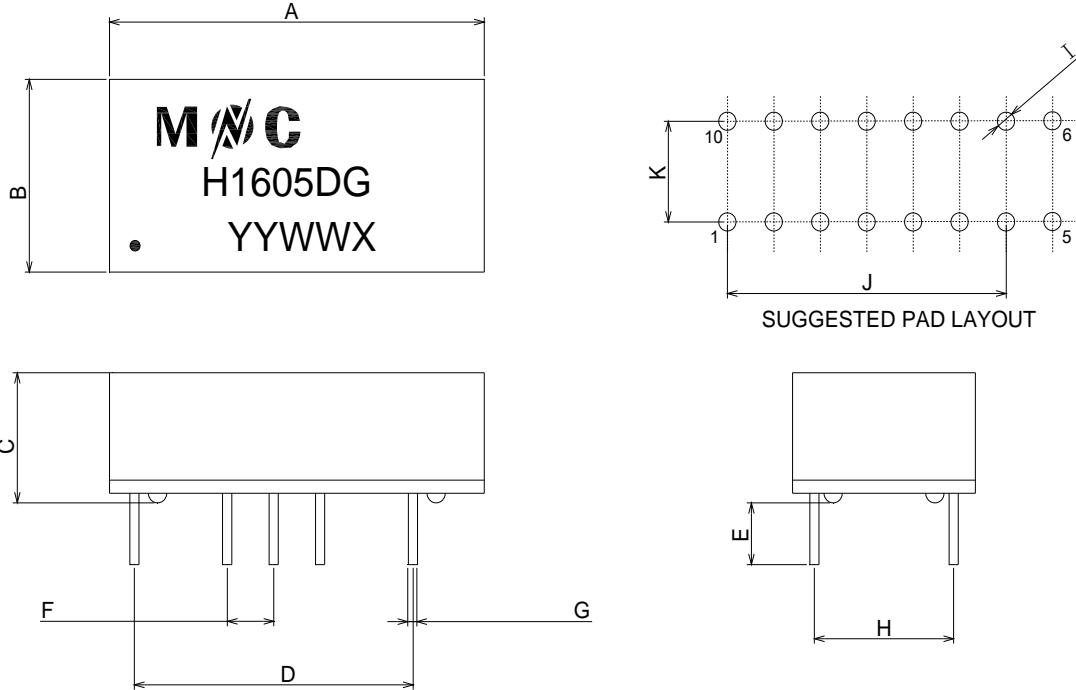
SPECIFICATION
Part No. H1605DG
A. MECHANICAL :

Pin2.6.8.9.11.15 cut off

Note: White ink marking

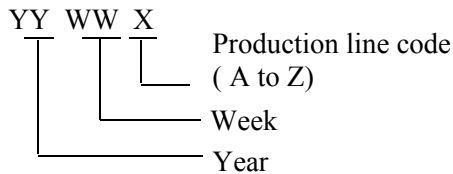

- 1.UNITS:mm/inch.
- 2.UNLESS OTHERWISE SPECIFIED ALL TOLERANCES ARE: TYPICAL
- 3.PIN LENGTH DON'T INCLUDE SOLDER POINT

DIM	MILLIMETERS			INCHES		
	MIN	NOM	MAX	MIN	NOM	MAX
A	19.80	20.30	20.80	0.780	0.799	0.819
B	9.20	9.70	10.20	0.362	0.382	0.402
C	/	/	7.10	/	/	0.280
D	/	15.24	/	/	0.600	/
E	2.90	3.20	3.50	0.114	0.126	/
F	/	2.54	/	/	0.100	/
G	/	0.50	/	/	0.020	/
H	7.12	7.62	8.12	0.280	0.300	0.320
I	/	0.80	/	/	0.031	/
J	/	15.24	/	/	0.600	/
K	/	7.62	/	/	0.300	/

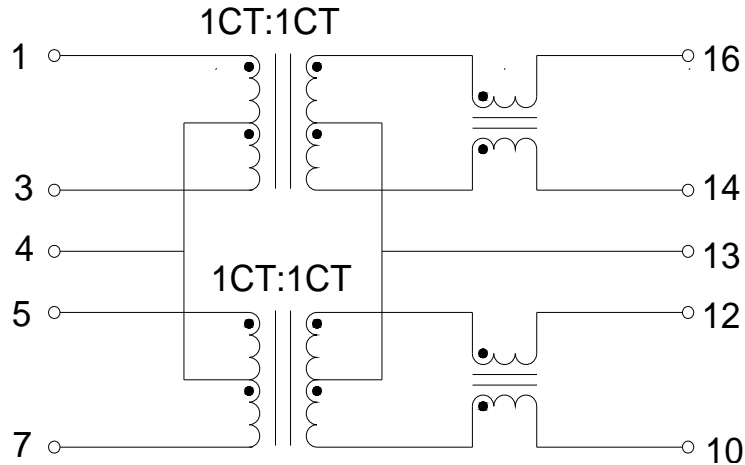
SPECIFICATION
Part No. H1605DG
B. SCHEMATIC :

C. ELECTRICAL SPECIFICATION @25°C

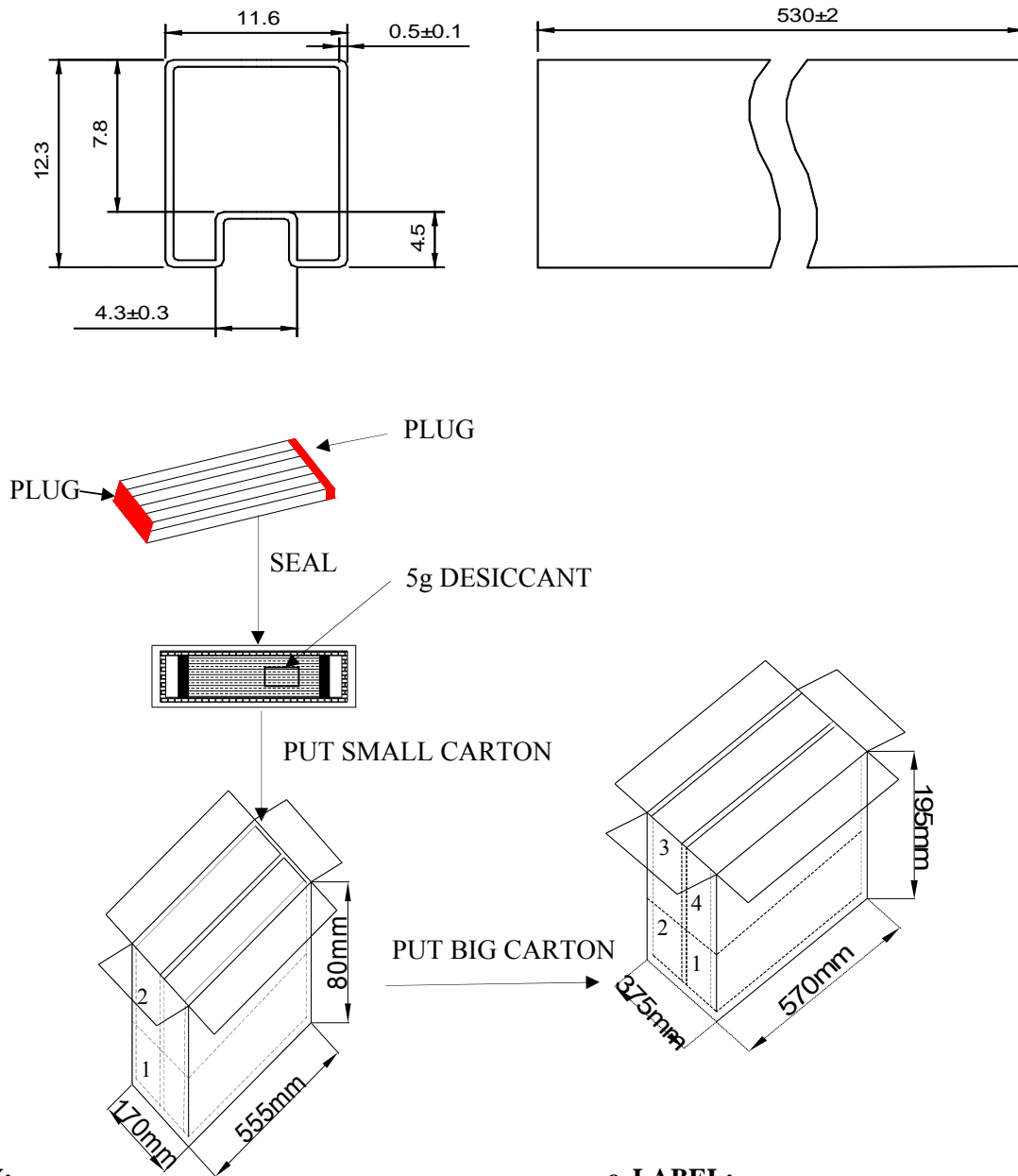
ITEM	SPECIFICATION	TEST CONDITION	TEST EQUIPMENT
INDUCTANCE :	350uH MIN.	100KHz 0.2V 8mA DC Bias	TH2819XB OR EQU.
LEAKAGE INDUCTANCE :	0.50uH MAX.	100KHz 0.2V	TH2819XB OR EQU.
INTERWINDING CAPACITANCE :	50pF TYP.	100KHz 0.2V	TH2819XB OR EQU.
DC RESISTANCE :	1.2Ω MAX.	AT 25 °C	TH2819XB OR EQU.
TURNS RATIO :	1CT:1CT±5%		TH2819XB OR EQU.
POLARITY :	1-16,5-12 IN-PHASE		
INSERTION LOSS :	-1.1dB MAX.	0.5-100 MHz	E5061A OR EQU.
RETURN LOSS :	-18dB MIN.	0.5-30 MHz	E5061A OR EQU.
	-18+20*log(f/30)dB MIN.	30.1-60MHz	
	-12dB MIN.	60.1-80MHz	
CROSS TALK :	-35dB MIN.	0.5-40 MHz	E5061A OR EQU.
	-33+20*log(f/50)dB MIN.	40.1-100 MHz	
CMRR :	-30dB MIN.	0.5-100 MHz	E5061A OR EQU.
ISOLATION HI-POT :PRI TO SEC	1500VAC	1mA,60S	7152AB OR EQU.
	1650VAC	1mA,6S	
OPERATING TEMPERATURE	0°C TO 70°C		

PACKAGE
Part No. H1605DG
D. PACKING:
a. PACKAGING AS BELOW (ONLY FOR A REFERENCE):

b. Q'TY:

- 25 PCS PER TUBE
- 5 TUBES PER BUNDLE (125 PCS)
- 10 BUNDLES PER BAG (1250 PCS)
- 1 BAG PER SMALL CARTON
- 4 SMALL CARTON PER BIG CARTON(5000PCS)

c. LABEL:

REMARK:

ABOVE PACKING IS FOR YOUR REFERENCE ONLY, WHICH MIGHT BE CHANGED WITHOUT NOTICE.

MATERIAL LIST
Part No. H1605DG
E.BOM

MATERIAL LIST					
NO.	ITEM	MATERIAL	RATING	SUPPLIER OF MATERIAL	UL
1	CORE	Mn-Zn	-----	YEAN SHING	N/A
			-----	ZHONGSHAN CRC ELECTRONICS FACTORY	N/A
		Ni-Zn	-----	YEAN SHING	N/A
			-----	ZHONGSHAN CRC ELECTRONICS FACTORY	N/A
2	COPPER WIRE	QPN180	180°C	ZHUHAI SUNTEK WIRE CO.,LTD	E234867
		Polysol 180	180°C	ELEKTRISOLA(MALAYSIA) SDN.BHD.	E258243
3	CASE	PF2A5-151J(b)	V-0	CHANGSHU SOUTH-EAST PLASTIC CO.,LTD	E136137
		T378J	V-0	CHANG CHUN CHEMICAL(ZHANGZHOU) CO.,LTD.	E59481
4	PIN	CP WIRE	-----	HIFAM	N/A
5	EPOXY	3300A/B	-----	DONGGUAN EATTO ELECTRONIC MATERIAL CO.,LTD	E218090

RECOMMENDED WAVE SOLDERING PROFILE**Part No. H1605DG****a. RECOMMENDED WAVE SOLDERING PROFILE:****CONDITION:**

- a.1. AVAILABLE FOR ALL THE THROUGH HOLE PARTS
- a.2. SOLDERING METHOD: WAVE SOLDERING
- a.3. SOLDER: Sn-0.7Cu
- a.4. THE RECOMMENDED WAVE SOLDERING CURVE IS AS BELOW

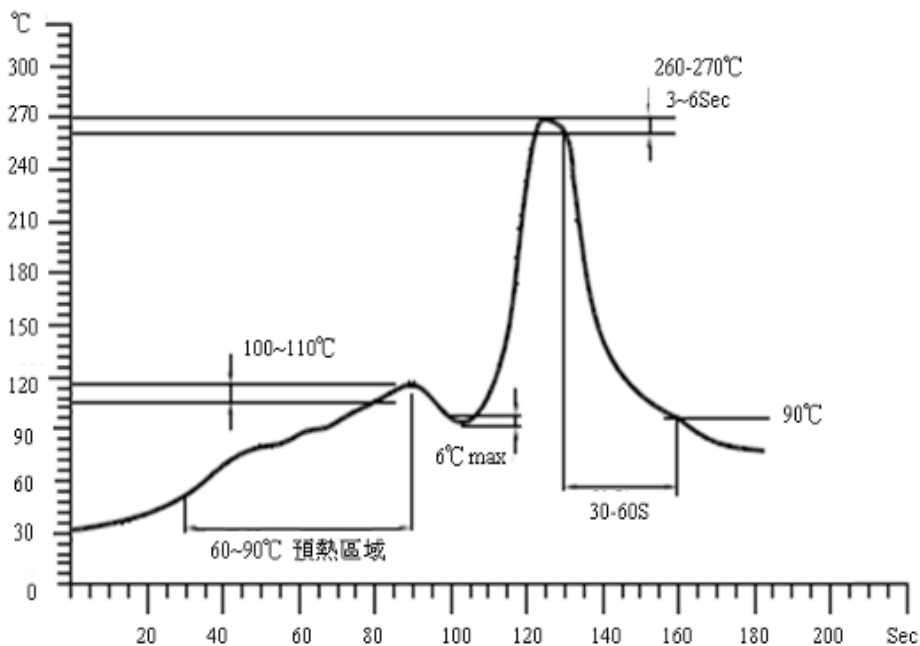
**b. MOISTURE SENSITIVE LEVEL:**

- b.1. LEVEL: 1
- b.2. SHELF LIFE: UNLIMITED
- b.3. STORAGE CONDITION: $\leq 30^{\circ}\text{C}/85\% \text{RH}$