

10-Channel Level Shifter and VCOM Buffer

FEATURES

- 10-Channel Level Shifter, Organized as Two Groups of 8 + 2 Channels
- Separate Positive Supplies (V_{GH}) for Each Group
- V_{GH} Levels up to 38V
- V_{GL} Levels down to -13V
- Logic Level Inputs
- High Peak Output Currents
- High-Speed V_{COM} Buffer
- 28-Pin 5x5 mm QFN Package

APPLICATIONS

- Large Format LCD Displays using GIP Technology

DESCRIPTION

The TPS65190 is a combined multi-channel level-shifter and V_{COM} buffer intended for use in large format LCD display applications such as TVs and monitors. The device converts the logic-level signals generated by the Timing Controller (T-CON) to the high-level gate drive signals used by the display panel and amplifies/buffers an externally generated V_{COM} voltage.

The 10 level shifter channels are organized as 2 groups, each with its own positive supply. Channels 1-6 and 9-10 are supplied by V_{GH1} and channels 7-8 are supplied by V_{GH2} . The two positive supplies can be tied together if one positive supply voltage is used for all level shifter channels. Both level shifter groups use the same negative supply V_{GL} .

The level-shifters feature low impedance output stages that achieve fast rise and fall times even when driving significant capacitive loads.

The uncommitted high-speed operational amplifier features a high slew rate and high peak current capability that make it particularly suitable for driving the panel's common rail (V_{COM}).

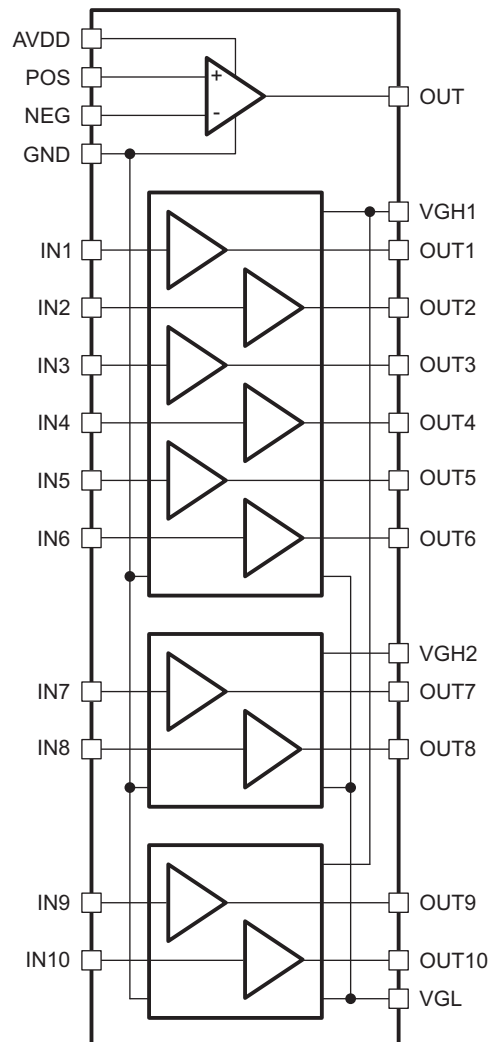

Please be aware that an important notice concerning availability, standard warranty, and use in critical applications of Texas Instruments semiconductor products and disclaimers thereto appears at the end of this data sheet.



These devices have limited built-in ESD protection. The leads should be shorted together or the device placed in conductive foam during storage or handling to prevent electrostatic damage to the MOS gates.

ORDERING INFORMATION⁽¹⁾

T _A	ORDERING	PACKAGE	PACKAGE MARKING
-40 to 85°C	TPS65190RHDR	28-Pin QFN	TPS65190

(1) The device is supplied taped and reeled, with 3000 devices per reel.

ABSOLUTE MAXIMUM RATINGS

over operating free-air temperature range (unless otherwise noted) ⁽¹⁾

	VALUE	UNIT
Voltage on VGH1, VGH2 ⁽²⁾	45	V
Voltage on VGL ⁽²⁾	-15	V
Voltage on AVDD ⁽²⁾	20	V
Voltage on IN1 through IN10 ⁽²⁾	-0.3 to 7.0	V
Voltage on POS, NEG ⁽²⁾	-0.3 to V _{AVDD} + 0.3	V
Differential voltage between POS and NEG	±V _{AVDD}	V
ESD Rating HBM	2	kV
ESD Rating MM	200	V
ESD Rating CDM	700	V
Continuous power dissipation	See Dissipation Rating Table	
T _A Operating ambient temperature range	-40 to 85	°C
T _J Operating junction temperature range	-40 to 150	°C
T _{STG} Storage temperature range	-65 to 150	°C

(1) Stresses beyond those listed under *absolute maximum ratings* may cause permanent damage to the device. These are stress ratings only and functional operation of the device at these or any other conditions beyond those indicated under recommended operating conditions is not implied. Exposure to absolute-maximum-rated conditions for extended periods may affect device reliability.

(2) Voltage values are with respect to the GND pin

DISSIPATION RATINGS

PACKAGE	θ _{JA}	T _A ≤ 25°C POWER RATING	T _A = 70°C POWER RATING	T _A = 85°C POWER RATING
28-Pin QFN ⁽¹⁾	35 °C/W	3.57 W	2.29 W	1.86 W

(1) Refer to application section on how to improve thermal resistance θ_{JA}.

RECOMMENDED OPERATING CONDITIONS

		MIN	TYP	MAX	UNIT
V _{GH1}	Positive supply voltage range	12	30	38	V
V _{GH2}		12	30	38	
V _{GL}	Negative supply voltage range	-2	-6.2	-13	V
V _{IN}	Level shifter input voltage range	3	3.3	5	V
V _{AVDD}	Operational amplifier positive supply voltage range	8	15	20	V
V _{POS} , V _{NEG}	Operational amplifier common-mode input voltage range	1	0.5 x V _{AVDD} -1		V
T _A	Operating ambient temperature	-40		85	°C
T _J	Operating junction temperature	-40		125	°C

ELECTRICAL CHARACTERISTICS
 $V_{GH1} = V_{GH2} = 30\text{ V}$; $V_{GL} = -6.2\text{ V}$; $V_{AVDD} = 15\text{ V}$; $T_A = -40\text{ }^\circ\text{C}$ to $85\text{ }^\circ\text{C}$; typical values are at $25\text{ }^\circ\text{C}$ unless otherwise noted.

PARAMETER		TEST CONDITIONS	MIN	TYP	MAX	UNIT
LEVEL SHIFTER						
I_{GH1}	V_{GH1} Supply current	IN1 to IN10 = GND		0.18	1	mA
I_{GH2}	V_{GH2} Supply current	IN1 to IN10 = GND		0.012	0.1	mA
I_{GL}	V_{GL} Supply current	IN1 to IN10 = GND		0.015	0.1	mA
I_{OUTX}	Peak output current	Channels 1-8, sourcing		490		mA
		Channels 1-8, sinking		850		
		Channels 9-10, sourcing		250		
		Channels 9-10, sinking		450		
I_{INX}	Input current	Channels 1-10, inputs connected to GND		-0.003	± 1	μA
		Channels 1-10, inputs connected to 3.3 V		-0.002	± 1	
V_{IH}	High level input threshold	Channels 1 through 10			2.0	V
V_{IL}	Low level input threshold	Channels 1 through 10	0.5			V
V_{DROPH}	Output voltage drop high	Channels 1 through 8, $I_{OUT} = 10\text{ mA}$		0.19	0.4	V
		Channels 9 and 10, $I_{LOAD} = 10\text{ mA}$		0.36	1	
V_{DROPL}	Output voltage drop low	Channels 1 through 8, $I_{OUT} = -10\text{ mA}$		0.06	0.4	V
		Channels 9 and 10, $I_{OUT} = -10\text{ mA}$		0.11	1	
t_R	Rise time	Channels 1 through 8, $C_{OUT} = 4.7\text{ nF}^{(1)}$		404	600	ns
		Channels 9 and 10, $C_{OUT} = 4.7\text{ nF}^{(1)}$		740	950	
t_F	Fall time	Channels 1 through 8, $C_{OUT} = 4.7\text{ nF}^{(1)}$		192	370	ns
		Channels 9 and 10, $C_{OUT} = 4.7\text{ nF}^{(1)}$		377	700	
t_{PH}	Propagation delay	Rising edge, $C_{OUT} = 150\text{ pF}$		27		ns
t_{PL}		Falling edge, $C_{OUT} = 150\text{ pF}$		40		
OPERATIONAL AMPLIFIER						
I_{AVDD}	Supply current	$V_{CM} = 7.5\text{ V}$, unity gain, no load		5.4		mA
V_{OS}	Input offset voltage	$V_{CM} = 7.5\text{ V}$		1	± 20	mV
I_{IB}	Input bias current	$V_{CM} = 7.5\text{ V}$		0.001	± 0.1	μA
V_{CM}	Common-mode input voltage range	$V_{AVDD} = 8\text{ V}$ to 20 V	1		$V_{AVDD} - 1$	V
CMRR	Common mode rejection ratio	$V_{CM} = 1\text{ V}$ to 14 V , 1 Hz, no load		93		dB
A_{VOL}	Open loop gain	$V_{OUT} = 0.5\text{ V}$ to 14.5 V , no load		88		dB
V_{DROPL}	Output voltage drop low	$I_O = -10\text{ mA}$		52	200	mV
V_{DROPH}	Output voltage drop high	$I_O = 10\text{ mA}$		85	200	mV
PSRR	Power supply rejection ratio	Measured at 1 Hz		90		dB
BW	Small signal unity gain bandwidth	-3 dB, $V_{IN} = 100\text{ mV}_{PP}$		76		MHz
SR	Slew rate, rising	$A_V = 1$, $V_{CM} = 7.5\text{ V}$, $V_{IN} = 2\text{ V}_{PP}$		66		V/ μs
	Slew rate, falling			53		
I_O	Output current	Peak, $V_{CM} = 7.5\text{ V}$	± 200	± 450		mA
		$V_{OUT} = 13\text{ V}$, sourcing	100	225		
		$V_{OUT} = 2\text{ V}$, sinking	-100	317		
I_{SC}	Short circuit current	OUT shorted to GND or AVDD ⁽²⁾	± 250	± 498	± 900	mA

(1) Rise and fall times are measured between 10% and 90% of the waveform's maximum amplitude.

(2) To prevent overheating, short-circuit conditions must not be allowed to persist indefinitely. The maximum allowable duration of short-circuit conditions will be determined by the IC's junction-to-ambient thermal resistance (θ_{JA}) and the ambient temperature of the application.

DEVICE INFORMATION

PIN ASSIGNMENT

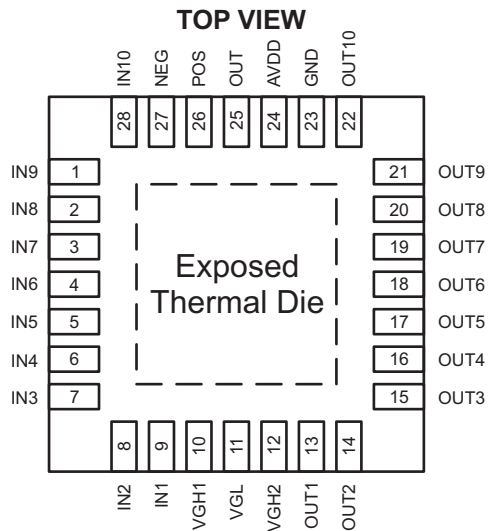

PIN FUNCTIONS

PIN		I/O	DESCRIPTION
NAME	NO.		
IN9	1	I	Level shifter channel 9 input
IN8	2	I	Level shifter channel 8 input
IN7	3	I	Level shifter channel 7 input
IN6	4	I	Level shifter channel 6 input
IN5	5	I	Level shifter channel 5 input
IN4	6	I	Level shifter channel 4 input
IN3	7	I	Level shifter channel 3 input
IN2	8	I	Level shifter channel 2 input
IN1	9	I	Level shifter channel 1 input
VGH1	10	P	Positive supply for level shifter channels 1-6 and 9-10
VGL	11	P	Negative supply voltage for all level shifter channels
VGH2	12	P	Positive supply for level shifter channels 7-8
OUT1	13	O	Level shifter channel 1 output
OUT2	14	O	Level shifter channel 2 output
OUT3	15	O	Level shifter channel 3 output
OUT4	16	O	Level shifter channel 4 output
OUT5	17	O	Level shifter channel 5 output
OUT6	18	O	Level shifter channel 6 output
OUT7	19	O	Level shifter channel 7 output
OUT8	20	O	Level shifter channel 8 output
OUT9	21	O	Level shifter channel 9 output
OUT10	22	O	Level shifter channel 10 output
GND	23	P	Ground connection for level shifter and operational amplifier.
AVDD	24	P	Operational amplifier positive supply
OUT	25	O	Operational amplifier output
NEG	26	I	Operational amplifier inverting input
POS	27	I	Operational amplifier non-inverting input

PIN FUNCTIONS (continued)

PIN		I/O	DESCRIPTION
NAME	NO.		
IN10	28	I	Level shifter channel 10 input
Exposed Thermal Die		P	Connect to the system V_{GL} connection.

TYPICAL CHARACTERISTICS

TABLE OF GRAPHS

LEVEL SHIFTER		
Rise time	Channels 1-8, $C_{OUT} = 8 \text{ pF}$	Figure 1
	Channels 1-8, $C_{OUT} = 4.7 \text{ nF}$	Figure 2
	Channels 9-10, $C_{OUT} = 8 \text{ pF}$	Figure 3
	Channels 9-10, $C_{OUT} = 4.7 \text{ nF}$	Figure 4
Fall time	Channels 1-8, $C_{OUT} = 8 \text{ pF}$	Figure 5
	Channels 1-8, $C_{OUT} = 4.7 \text{ nF}$	Figure 6
	Channels 9-10, $C_{OUT} = 8 \text{ pF}$	Figure 7
	Channels 9-10, $C_{OUT} = 4.7 \text{ nF}$	Figure 8
Propagation delay, channels 1 to 8	Channels 1-8, rising, $C_{OUT} = 8 \text{ pF}$	Figure 9
	Channels 1-8, falling, $C_{OUT} = 8 \text{ pF}$	Figure 10
	Channels 9-10, rising, $C_{OUT} = 8 \text{ pF}$	Figure 11
	Channels 9-10, falling, $C_{OUT} = 8 \text{ pF}$	Figure 12
Peak output current	Channels 1-8, $C_{OUT} = 10 \text{ nF}$	Figure 13
	Channels 9-10, $C_{OUT} = 10 \text{ nF}$	Figure 14
Output voltage drop	Output low	Figure 15
	Output high	Figure 16
OPERATIONAL AMPLIFIER		
Small signal frequency response	$V_{CM} = 7.5 \text{ V}$, $V_{IN} = 100 \text{ mV}_{PP}$	Figure 17
Output voltage drop		Figure 18
Slew rate	Output rising, $C_{OUT} = 150 \text{ pF}$	Figure 19
	Output falling, $C_{OUT} = 150 \text{ pF}$	Figure 20

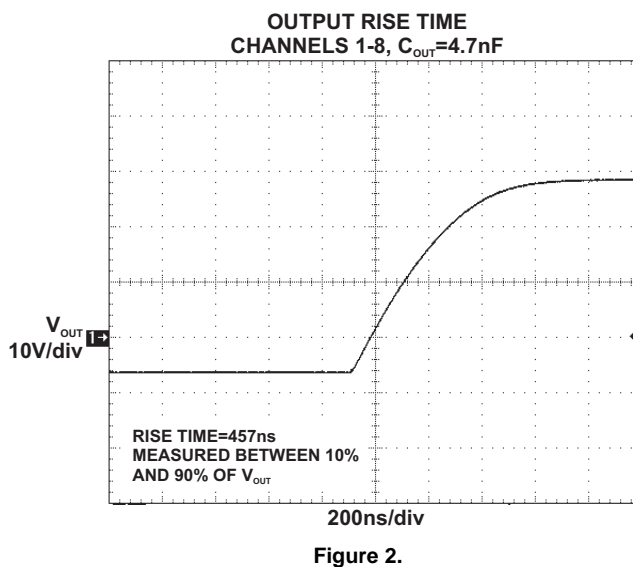
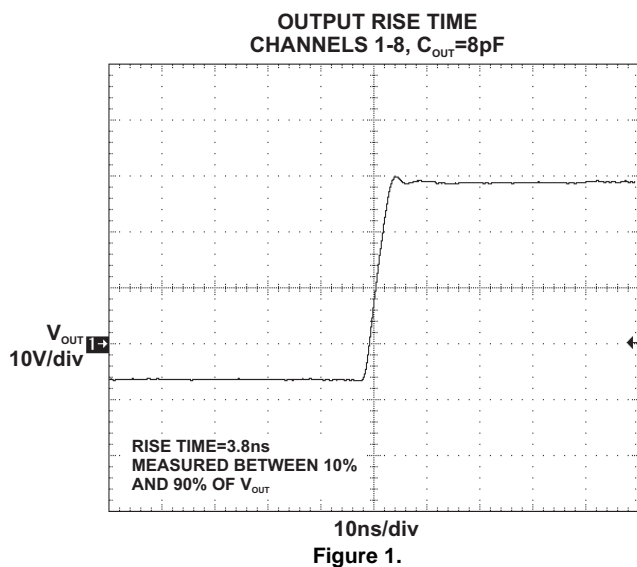

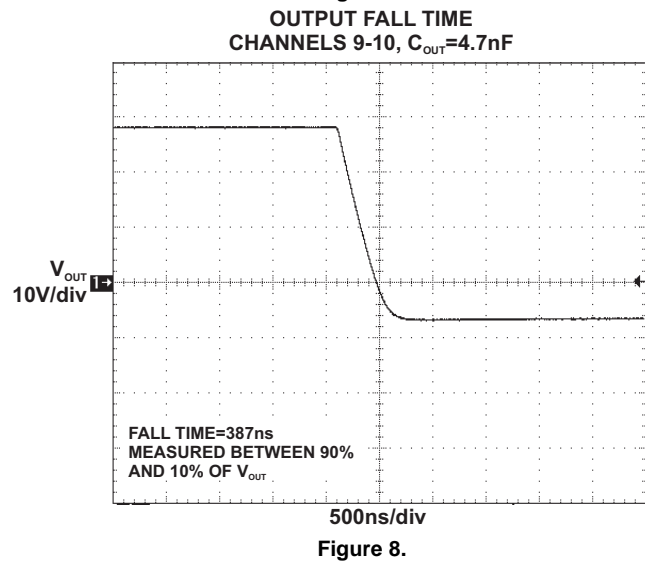
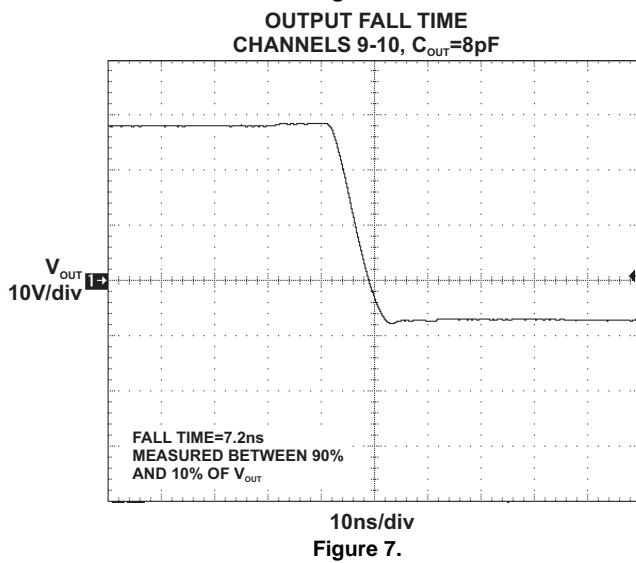
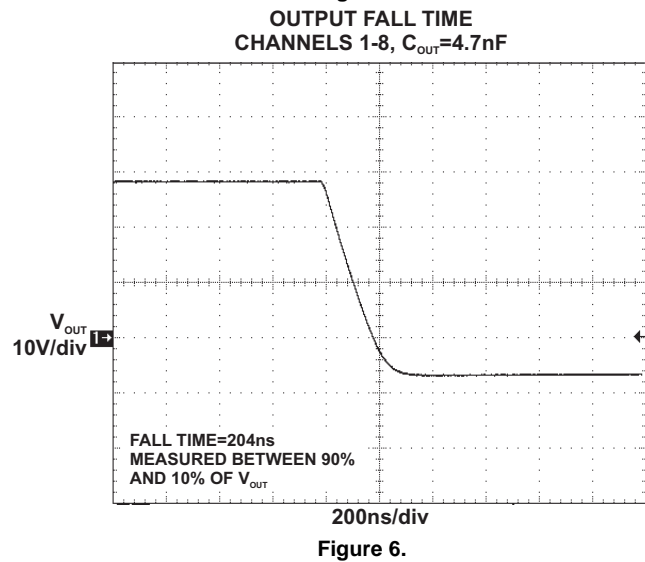
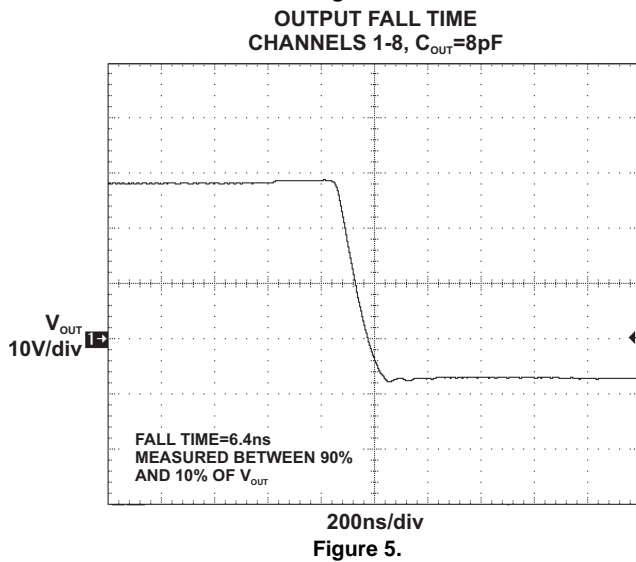
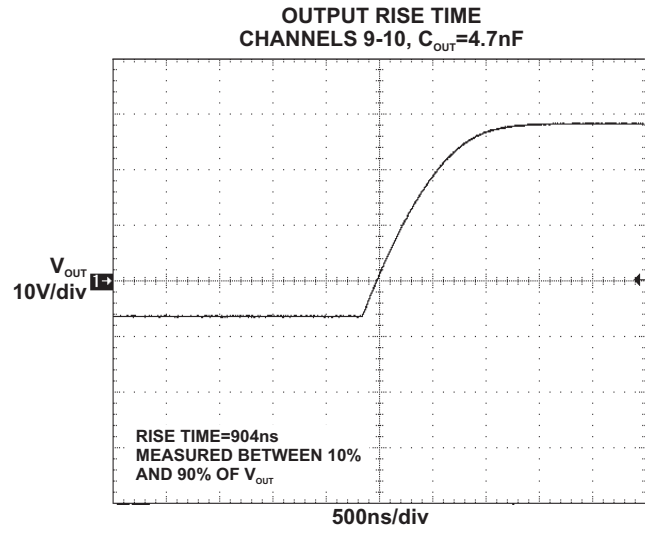
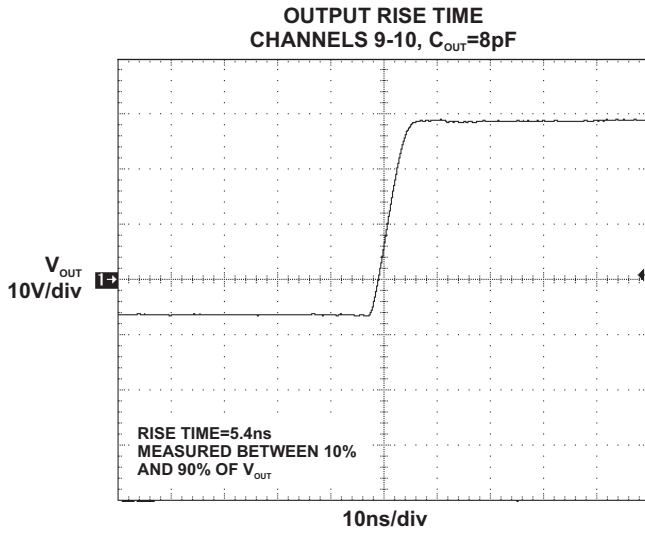

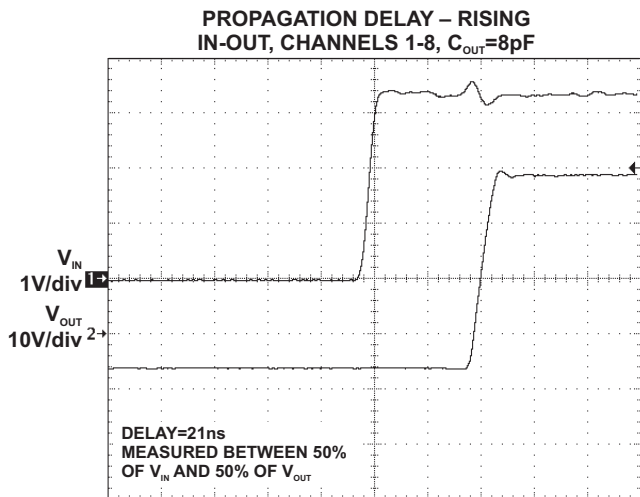

10ns/div
Figure 9.

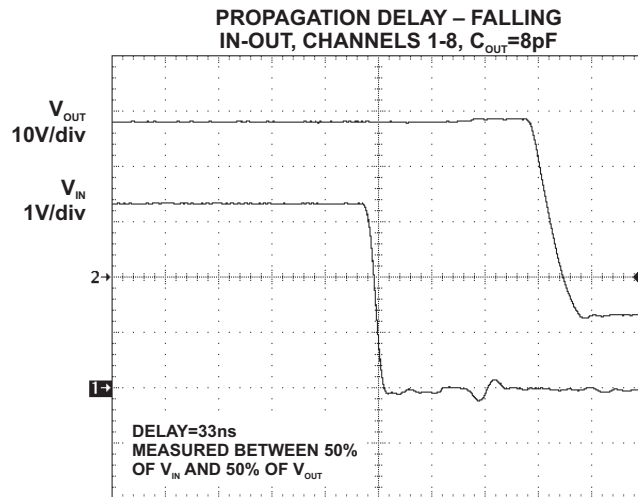

10ns/div
Figure 10.

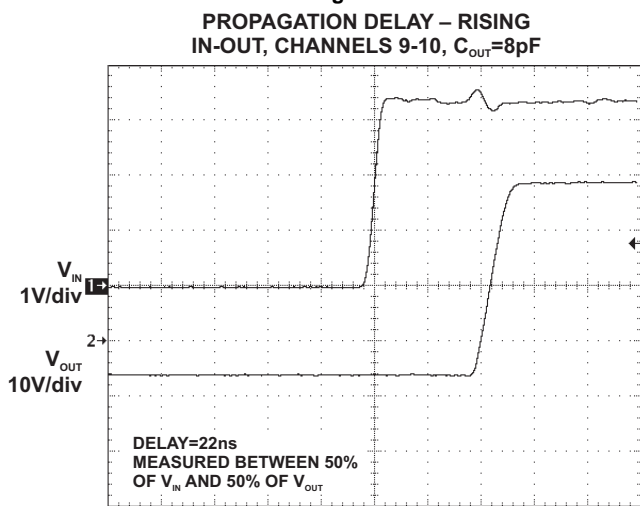

10ns/div
Figure 11.

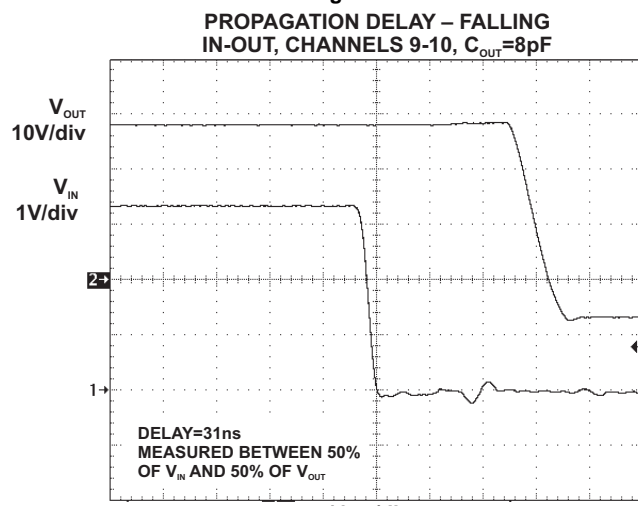

10ns/div
Figure 12.

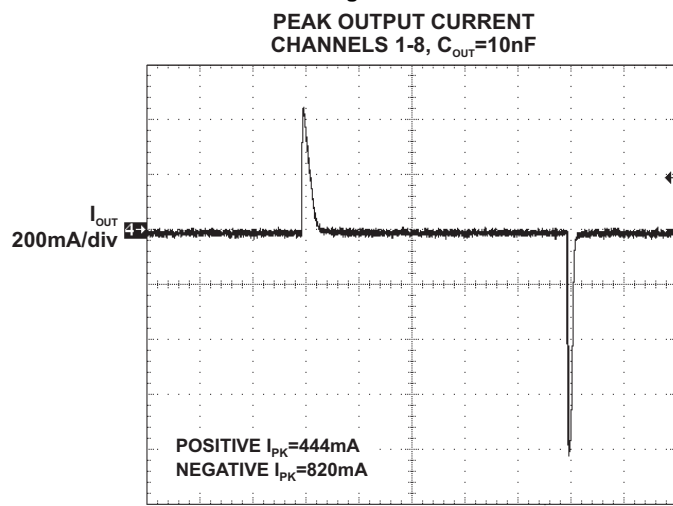

5μs/div
Figure 13.

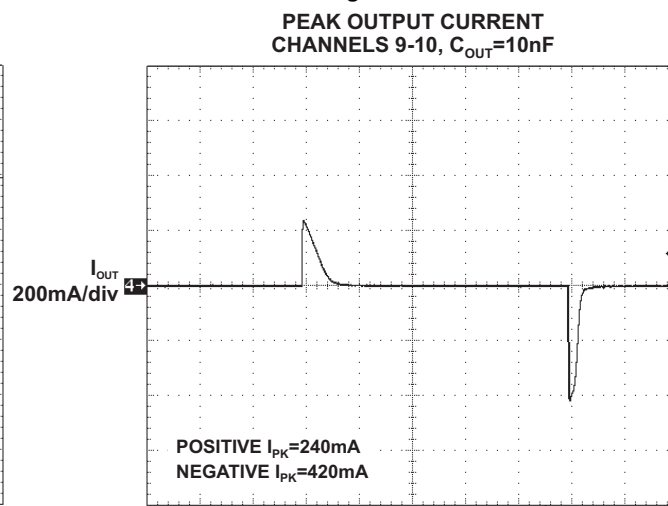

5μs/div
Figure 14.

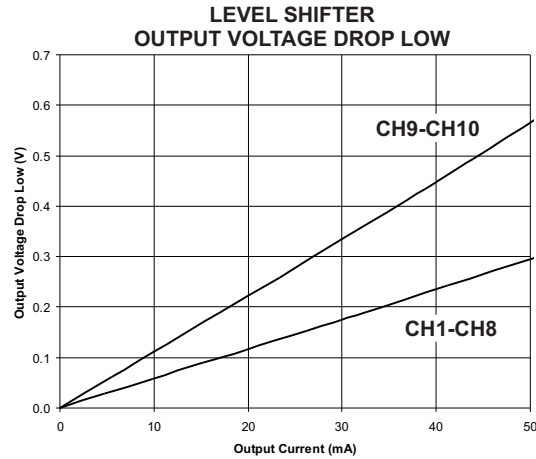

Figure 15.

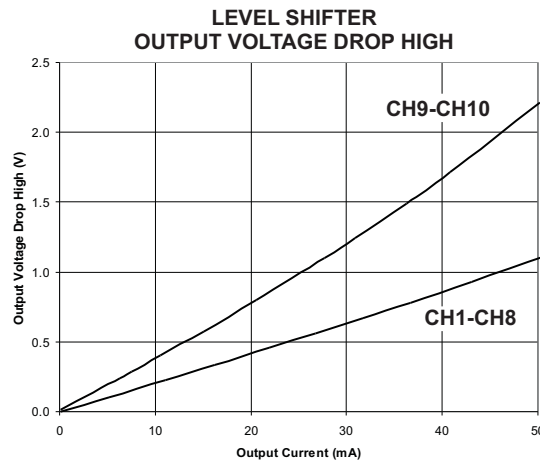

Figure 16.

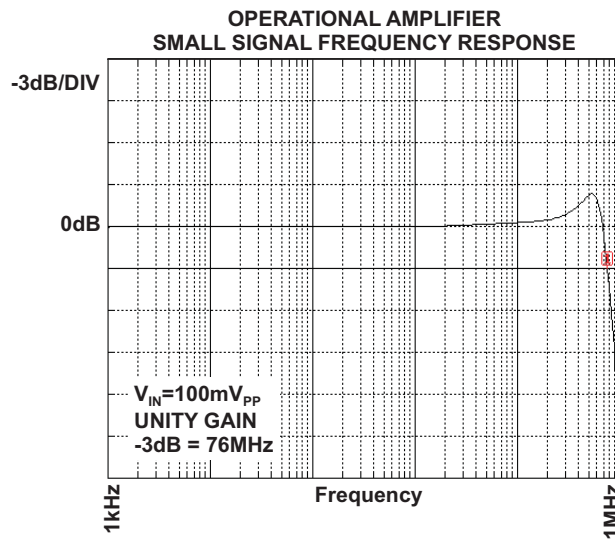

Figure 17.

OPERATIONAL AMPLIFIER
OUTPUT VOLTAGE DROP

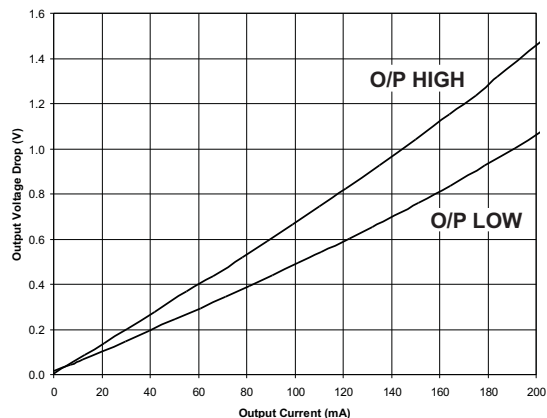

Figure 18.

OPERATIONAL AMPLIFIER
POSITIVE SLEW RATE, $C_{OUT}=150pF$

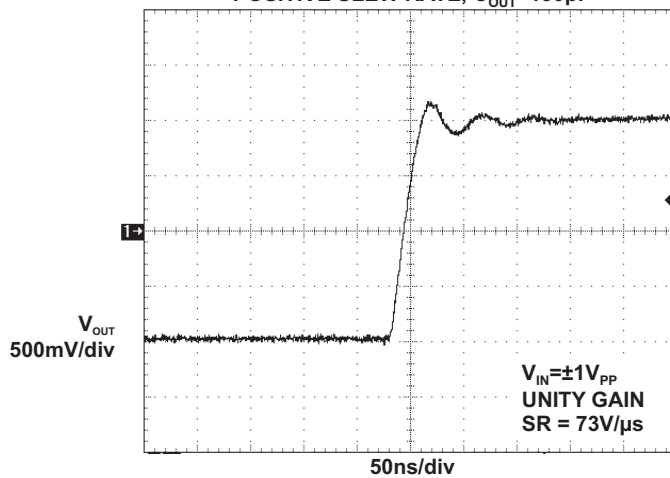

Figure 19.

OPERATIONAL AMPLIFIER
NEGATIVE SLEW RATE, $C_{OUT}=150pF$

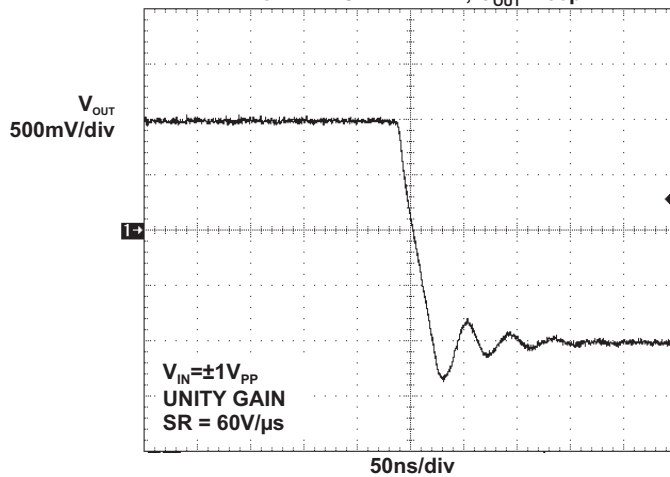

Figure 20.

DETAILED DESCRIPTION

The TPS65190 contains 10 level shifter channels and one high-speed operational amplifier.

The 10 level shifter channels are organized in two groups: the first group, comprising channels 1-6 and 9-10 is powered from V_{VGH1} and V_{GL} ; the second group, comprising channels 7 and 8 is powered from V_{VGH2} and V_{GL} . Channels 1 to 8 are optimized for high speed operation while channels 9 and 10 operate a little slower.

All level shifter channels feature the same input circuitry and are compatible with the standard logic-level signals generated by timing controllers in typical applications. The output circuitry has been designed to achieve high rise and fall times when driving the capacitive loads typically encountered in LCD display applications

The input and output stages of the operational amplifier extend close to both supply rails and the output stage has been optimized to supply the fast transient currents typical in V_{COM} applications.

APPLICATION INFORMATION

It is recommended to use high quality ceramic capacitors to decouple each supply pin. In typical applications 10 μF is recommended for V_{VGH1} and V_{GL} , while 1 μF is normally sufficient for V_{VGH2} .

Use level shifter channels 1 to 8 for high-speed clock signals and use channels 9 to 10 for lower-speed signals (see Figure 14). The inputs of any unused level shifter channels should be tied to GND. The outputs of any unused level shifter channels should be left floating.

It is recommended to use low-value feedback resistors with the VCOM buffer to minimize the effects of stray capacitance at its inverting input. Using high value feedback resistors can cause excessive peaking in the amplifier's gain response (caused by pole formed by the feedback resistor and the stray capacitance). If the VCOM buffer is used in a unity gain configuration, the flattest gain response is achieved using a direct connection between the amplifier's output and inverting input.

If the VCOM buffer is not used, tie AVDD, its inverting and non-inverting inputs, and its output to GND.

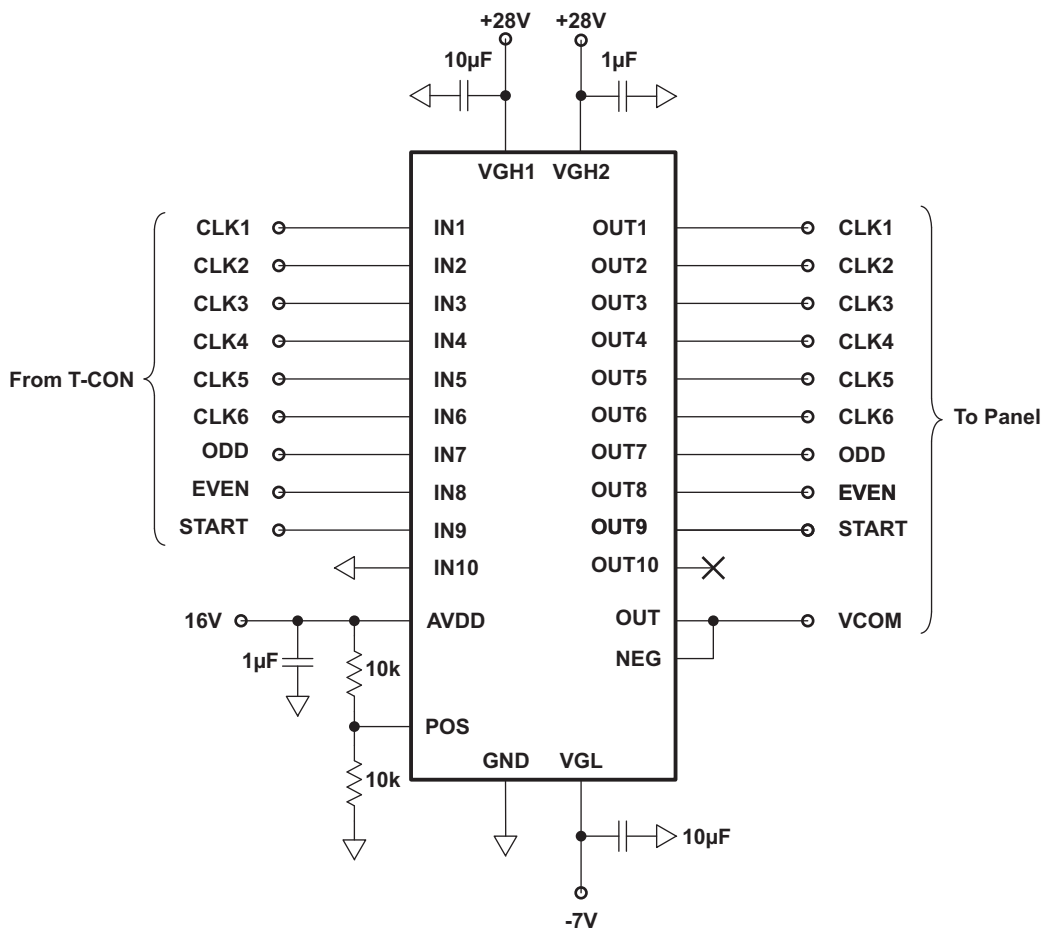

Figure 21. Typical Application Circuit

PCB LAYOUT

Proper PCB layout is essential if the TPS65190's specified performance is to be achieved, and the following basic steps should be followed as a minimum:

1. Use high quality ceramic decoupling capacitors, placed as close as possible to the IC pins they are decoupling
2. Use short, wide tracks to route power to the IC
3. Ensure that the PCB's thermal design is adequate to dissipate power away from the IC

The TPS65190 is supplied in a 28-Pin QFN thermally enhanced package designed to eliminate the use of bulky heat sinks and slugs. In order to benefit from these superior thermal properties PCB layout and manufacturing should follow the guidelines contained in the following application reports, available for free download from <http://www.ti.com>.

- Application Report – QFN Layout Guidelines ([SLOA122](#))
- Application Report – QFN/SON PCB Attachment ([SLUA271A](#))

PACKAGING INFORMATION

Orderable Device	Status (1)	Package Type	Package Drawing	Pins	Package Qty	Eco Plan (2)	Lead finish/ Ball material (6)	MSL Peak Temp (3)	Op Temp (°C)	Device Marking (4/5)	Samples
TPS65190RHDR	ACTIVE	VQFN	RHD	28	3000	RoHS & Green	NIPDAU	Level-2-260C-1 YEAR	-40 to 85	TPS 65190	Samples

(1) The marketing status values are defined as follows:

ACTIVE: Product device recommended for new designs.

LIFEBUY: TI has announced that the device will be discontinued, and a lifetime-buy period is in effect.

NRND: Not recommended for new designs. Device is in production to support existing customers, but TI does not recommend using this part in a new design.

PREVIEW: Device has been announced but is not in production. Samples may or may not be available.

OBsolete: TI has discontinued the production of the device.

(2) **RoHS:** TI defines "RoHS" to mean semiconductor products that are compliant with the current EU RoHS requirements for all 10 RoHS substances, including the requirement that RoHS substance do not exceed 0.1% by weight in homogeneous materials. Where designed to be soldered at high temperatures, "RoHS" products are suitable for use in specified lead-free processes. TI may reference these types of products as "Pb-Free".

RoHS Exempt: TI defines "RoHS Exempt" to mean products that contain lead but are compliant with EU RoHS pursuant to a specific EU RoHS exemption.

Green: TI defines "Green" to mean the content of Chlorine (Cl) and Bromine (Br) based flame retardants meet JS709B low halogen requirements of <=100ppm threshold. Antimony trioxide based flame retardants must also meet the <=1000ppm threshold requirement.

(3) MSL, Peak Temp. - The Moisture Sensitivity Level rating according to the JEDEC industry standard classifications, and peak solder temperature.

(4) There may be additional marking, which relates to the logo, the lot trace code information, or the environmental category on the device.

(5) Multiple Device Markings will be inside parentheses. Only one Device Marking contained in parentheses and separated by a "~" will appear on a device. If a line is indented then it is a continuation of the previous line and the two combined represent the entire Device Marking for that device.

(6) Lead finish/Ball material - Orderable Devices may have multiple material finish options. Finish options are separated by a vertical ruled line. Lead finish/Ball material values may wrap to two lines if the finish value exceeds the maximum column width.

Important Information and Disclaimer:The information provided on this page represents TI's knowledge and belief as of the date that it is provided. TI bases its knowledge and belief on information provided by third parties, and makes no representation or warranty as to the accuracy of such information. Efforts are underway to better integrate information from third parties. TI has taken and continues to take reasonable steps to provide representative and accurate information but may not have conducted destructive testing or chemical analysis on incoming materials and chemicals. TI and TI suppliers consider certain information to be proprietary, and thus CAS numbers and other limited information may not be available for release.

In no event shall TI's liability arising out of such information exceed the total purchase price of the TI part(s) at issue in this document sold by TI to Customer on an annual basis.

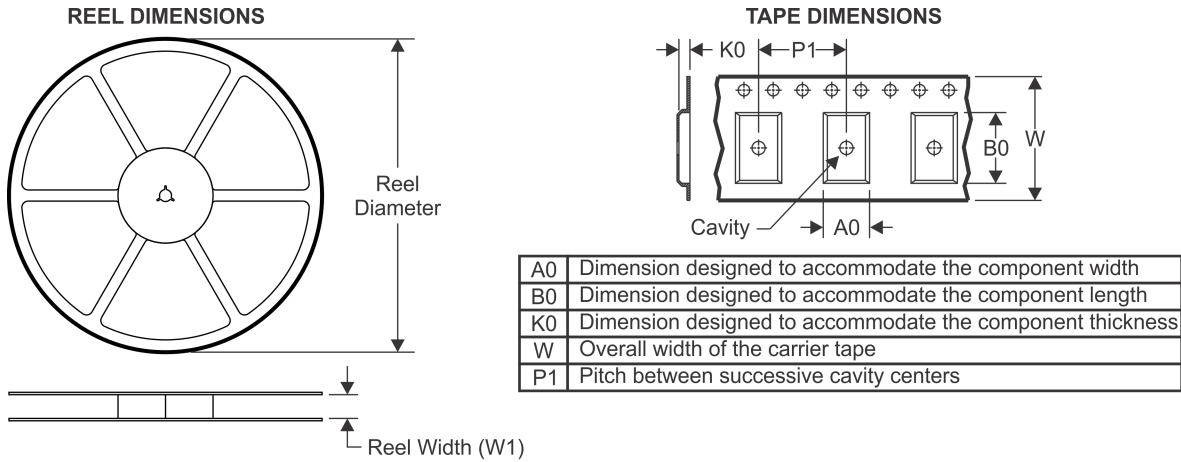
TAPE AND REEL INFORMATION

QUADRANT ASSIGNMENTS FOR PIN 1 ORIENTATION IN TAPE

*All dimensions are nominal

Device	Package Type	Package Drawing	Pins	SPQ	Reel Diameter (mm)	Reel Width W1 (mm)	A0 (mm)	B0 (mm)	K0 (mm)	P1 (mm)	W (mm)	Pin1 Quadrant
TPS65190RHDR	VQFN	RHD	28	3000	330.0	12.4	5.3	5.3	1.5	8.0	12.0	Q2

TAPE AND REEL BOX DIMENSIONS



*All dimensions are nominal

Device	Package Type	Package Drawing	Pins	SPQ	Length (mm)	Width (mm)	Height (mm)
TPS65190RHDR	VQFN	RHD	28	3000	853.0	449.0	35.0

GENERIC PACKAGE VIEW

RHD 28

VQFN - 1 mm max height

5 x 5 mm, 0.5 mm pitch

PLASTIC QUAD FLATPACK - NO LEAD

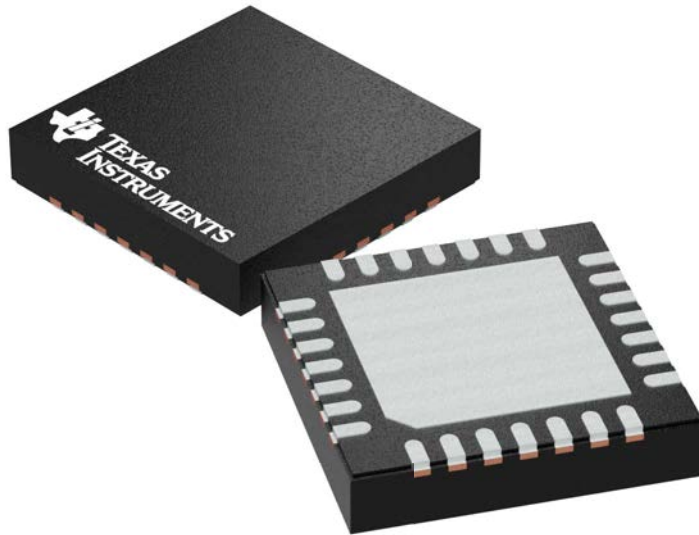

Images above are just a representation of the package family, actual package may vary.
Refer to the product data sheet for package details.

4204400/G

EXAMPLE BOARD LAYOUT

RHD0028B

VQFN - 1 mm max height

PLASTIC QUAD FLATPACK - NO LEAD

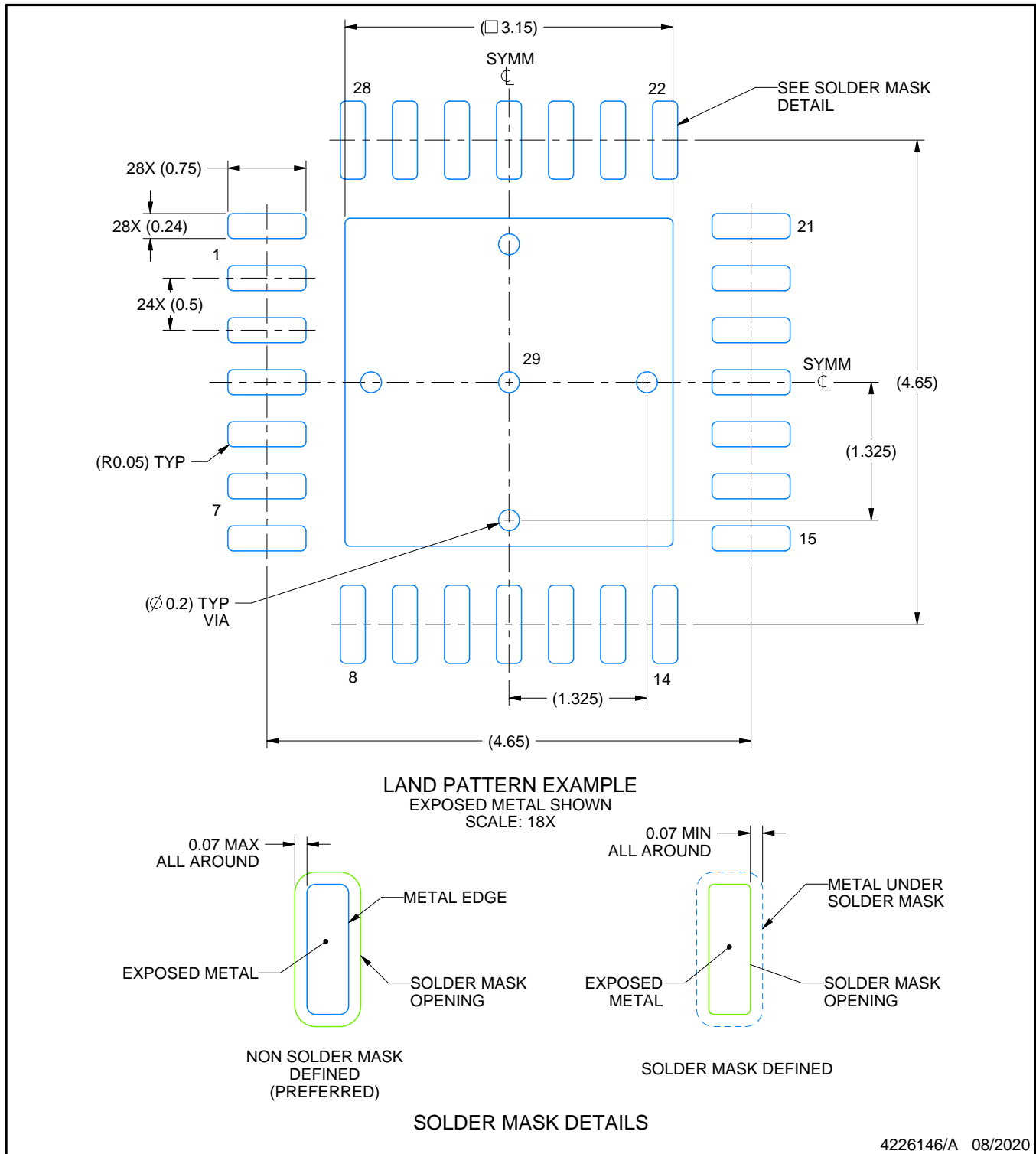

4226146/A 08/2020

NOTES: (continued)

4. This package is designed to be soldered to a thermal pad on the board. For more information, see Texas Instruments literature number SLUA271 (www.ti.com/lit/sluea271).
5. Vias are optional depending on application, refer to device data sheet. If any vias are implemented, refer to their locations shown on this view. It is recommended that vias under paste be filled, plugged or tented.

EXAMPLE STENCIL DESIGN

RHD0028B

VQFN - 1 mm max height

PLASTIC QUAD FLATPACK - NO LEAD

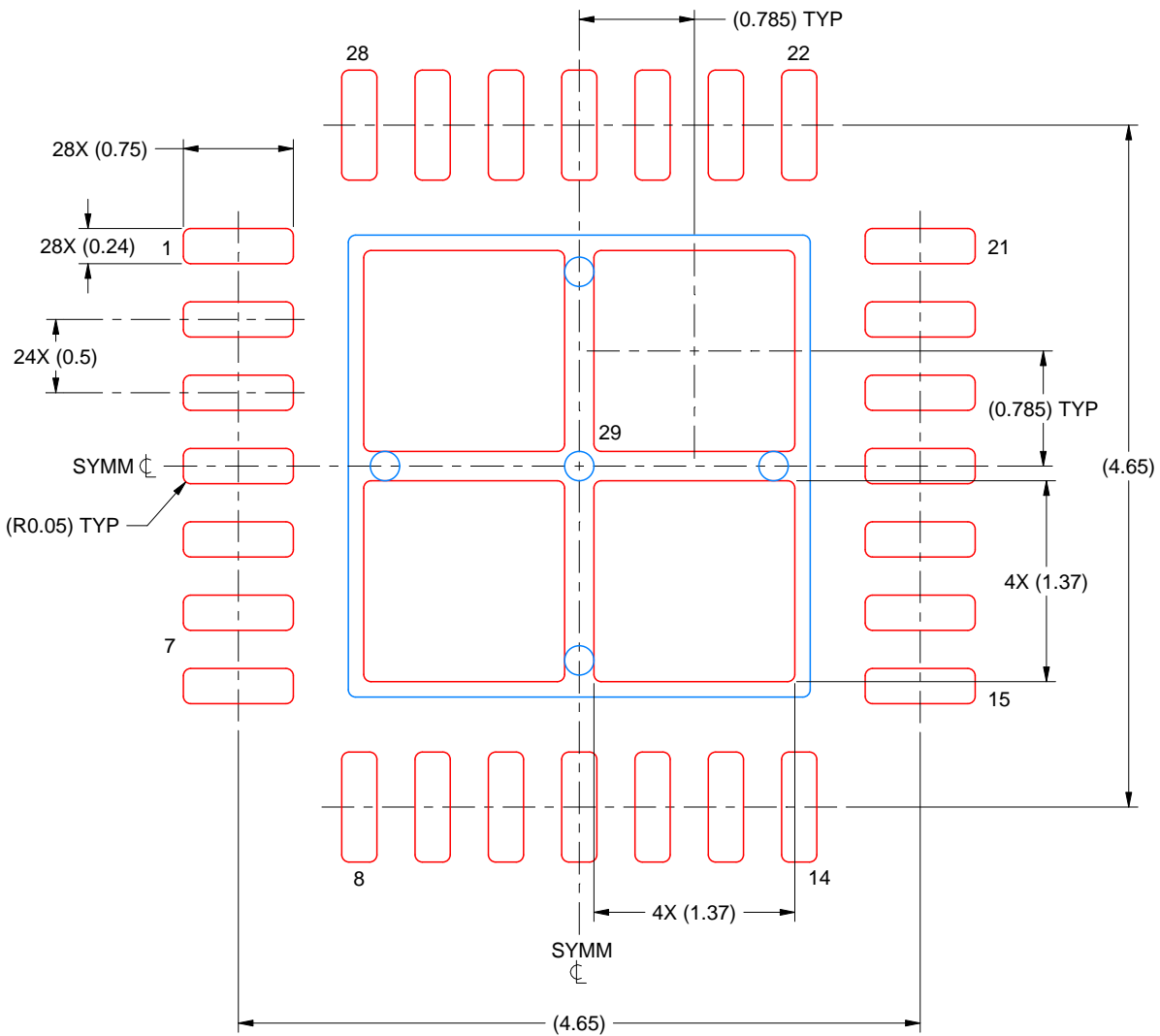

SOLDER PASTE EXAMPLE
 BASED ON 0.125 MM THICK STENCIL
 SCALE: 20X

EXPOSED PAD 29
 76% PRINTED SOLDER COVERAGE BY AREA UNDER PACKAGE

4226146/A 08/2020

NOTES: (continued)

6. Laser cutting apertures with trapezoidal walls and rounded corners may offer better paste release. IPC-7525 may have alternate design recommendations.

IMPORTANT NOTICE AND DISCLAIMER

TI PROVIDES TECHNICAL AND RELIABILITY DATA (INCLUDING DATASHEETS), DESIGN RESOURCES (INCLUDING REFERENCE DESIGNS), APPLICATION OR OTHER DESIGN ADVICE, WEB TOOLS, SAFETY INFORMATION, AND OTHER RESOURCES "AS IS" AND WITH ALL FAULTS, AND DISCLAIMS ALL WARRANTIES, EXPRESS AND IMPLIED, INCLUDING WITHOUT LIMITATION ANY IMPLIED WARRANTIES OF MERCHANTABILITY, FITNESS FOR A PARTICULAR PURPOSE OR NON-INFRINGEMENT OF THIRD PARTY INTELLECTUAL PROPERTY RIGHTS.

These resources are intended for skilled developers designing with TI products. You are solely responsible for (1) selecting the appropriate TI products for your application, (2) designing, validating and testing your application, and (3) ensuring your application meets applicable standards, and any other safety, security, or other requirements. These resources are subject to change without notice. TI grants you permission to use these resources only for development of an application that uses the TI products described in the resource. Other reproduction and display of these resources is prohibited. No license is granted to any other TI intellectual property right or to any third party intellectual property right. TI disclaims responsibility for, and you will fully indemnify TI and its representatives against, any claims, damages, costs, losses, and liabilities arising out of your use of these resources.

TI's products are provided subject to TI's Terms of Sale (www.ti.com/legal/termsofsale.html) or other applicable terms available either on ti.com or provided in conjunction with such TI products. TI's provision of these resources does not expand or otherwise alter TI's applicable warranties or warranty disclaimers for TI products.

Mailing Address: Texas Instruments, Post Office Box 655303, Dallas, Texas 75265
Copyright © 2020, Texas Instruments Incorporated