

DC Brushless Fan Motor Drivers

Multifunction Single-phase Full-wave Fan Motor Driver



BD6975FV

●General description

BD6975FV is a 1chip driver that composes H-bridge of power DMOS FET. Moreover, it corresponds to the large current motor, compared with old drivers, because the regenerative method of motor current and the driving block are optimized.

●Package

SSOP-B14

W (Typ.) x D (Typ.) x H (Max.)

5.00mm x 6.40mm x 1.35mm

●Features

- SSOP small package
- Driver including power DMOS FET
- Speed controllable by DC / direct PWM input
- Hi-Eff switching
- Quick start
- Current limit
- Lock protection and automatic restart
- Rotation speed pulse signal (FG) output



●Application

- Fan motors for general consumer equipment of desktop PC, and Projector, etc.

●Absolute maximum ratings

| Parameter | Symbol | Limit | Unit |
|---|------------------|---------------------|------|
| Supply voltage | Vcc | 20 | V |
| Power dissipation | Pd | 874.7 ^{*1} | mW |
| Operating temperature range | Topr | -40 to +100 | °C |
| Storage temperature range | Tstg | -55 to +150 | °C |
| Output voltage | Vo | 20 | V |
| Output current | Io | 1.2 ^{*2} | A |
| Rotation speed pulse signal (FG) output voltage | Vfg | 20 | V |
| Rotation speed pulse signal (FG) output current | I _{fg} | 10 | mA |
| Reference voltage (REF) output current | I _{ref} | 5 | mA |
| Hall bias (HB) output current 1 | I _{hb1} | 12 ^{*3} | mA |
| Hall bias (HB) output current 2 | I _{hb2} | 5 ^{*4} | mA |
| Input voltage (H+, H-, TH, MIN, CS, LZST) | Vin | 7 | V |
| Junction temperature | Tj | 150 | °C |

*1 Reduce by 7.0mW/°C over Ta=25°C. (On 70.0mmx70.0mmx1.6mm glass epoxy board)

*2 This value is not to exceed Pd.

*3 The condition of Ta=0°C or more and Vcc=9V or more

*4 The condition of less than Ta=0°C and less than Vcc=9V

●Recommended operating conditions

| Parameter | Symbol | Limit | Unit |
|--|--------|-------------|------|
| Operating supply voltage range | Vcc | 3.5 to 17.0 | V |
| Operating input voltage range 1 (H+, H-) (more than Vcc=9V) | Vin1 | 0 to 7 | V |
| Operating input voltage range 1 (H+, H-) (less than Vcc=9V) | | 0 to Vcc-2 | V |
| Operating input voltage range 2 (TH, MIN, CS, LZST) | Vin2 | 0 to Vref | V |

●Pin configuration

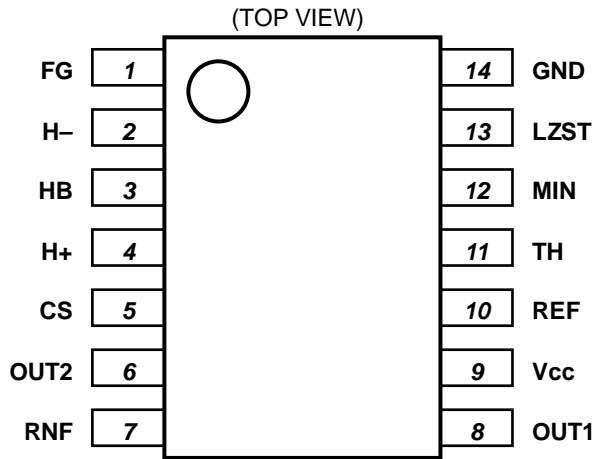

Fig.1 Pin configuration

●Pin description

| P/No. | T/Name | Function |
|-------|--------|--|
| 1 | FG | Speed pulse signal output terminal |
| 2 | H- | Hall - input terminal |
| 3 | HB | Hall bias terminal |
| 4 | H+ | Hall + input terminal |
| 5 | CS | Output current detection terminal |
| 6 | OUT2 | Motor output terminal 2 |
| 7 | RNF | Output current detecting resistor connecting terminal (motor ground) |
| 8 | OUT1 | Motor output terminal 1 |
| 9 | Vcc | Power supply terminal |
| 10 | REF | Reference voltage output terminal |
| 11 | TH | Output duty controllable input terminal |
| 12 | MIN | Minimum output duty setting terminal |
| 13 | LZST | Regenerative period setting terminal |
| 14 | GND | Ground terminal (signal ground) |

●Block diagram

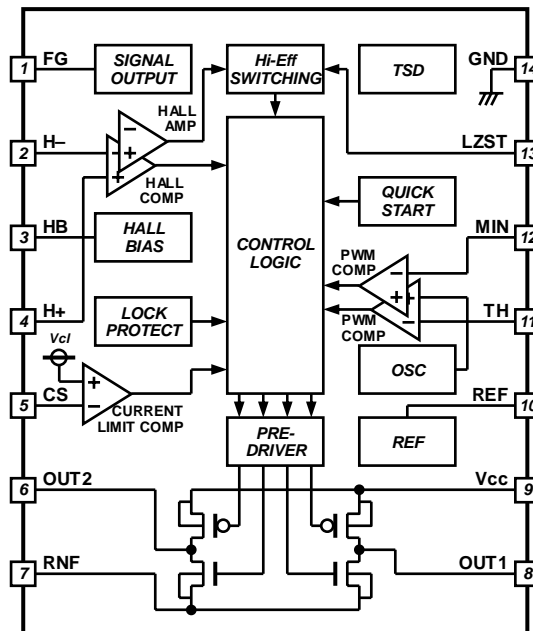

Fig.2 Block diagram

●I/O truth table

| Hall input | | Driver output | | |
|------------|----|---------------|------|------|
| H+ | H- | OUT1 | OUT2 | FG |
| H | L | L | H | Hi-Z |
| L | H | H | L | L |

H; High, L; Low, Hi-Z; High impedance
 FG output is open-drain type.

●Electrical characteristics(Unless otherwise specified Ta=25°C, Vcc=12V)

| Parameter | Symbol | Limit | | | Unit | Conditions | Ref. data |
|-------------------------------|-------------------|-------|------|------|------|--|------------|
| | | Min. | Typ. | Max. | | | |
| Circuit current | Icc | 1.5 | 3.3 | 5.0 | mA | | Fig.3 |
| Hall input offset voltage | Vofs | - | - | ±6 | mV | | Fig.4 |
| Output voltage | Vo | - | 0.4 | 0.6 | V | Io=±400mA High and low side total | Fig.5 to 8 |
| Lock detection ON time | Ton | 0.3 | 0.5 | 0.7 | s | | Fig.9 |
| Lock detection OFF time | Toff | 3.0 | 5.0 | 7.0 | s | | Fig.10 |
| Lock detection OFF/ON ratio | Rlck | 8.5 | 10.0 | 11.5 | - | Rlck=Toff / Ton | Fig.11 |
| FG output low voltage | Vfgl | - | 0.15 | 0.30 | V | I _{fg} =5mA | Fig.12, 13 |
| FG output leak current | I _{fgl} | - | - | 10 | μA | V _{fg} =17V | Fig.14 |
| OSC frequency | Fosc | 20.0 | 33.3 | 46.7 | kHz | | Fig.15 |
| OSC high voltage | Vosch | 2.3 | 2.5 | 2.7 | V | | Fig.16 |
| OSC low voltage | Voscl | 0.8 | 1.0 | 1.2 | V | | Fig.16 |
| Output ON duty 1 | Poh1 | 75 | 80 | 85 | % | V _{th} =V _{ref} x 0.217 Output 1kΩ load | Fig.17 |
| Output ON duty 2 | Poh2 | 45 | 50 | 55 | % | V _{th} =V _{ref} x 0.292 Output 1kΩ load | Fig.17 |
| Output ON duty 3 | Poh3 | 15 | 20 | 25 | % | V _{th} =V _{ref} x 0.367 Output 1kΩ load | Fig.17 |
| Reference voltage | V _{ref} | 5.7 | 6.0 | 6.3 | V | I _{ref} =-2mA | Fig.18, 19 |
| Hall bias voltage | V _{hb} | 1.05 | 1.25 | 1.45 | V | I _{hb} =-2mA | Fig.20, 21 |
| Current limit setting voltage | V _{cl} | 235 | 265 | 295 | mV | | Fig.22 |
| TH input bias current | I _{th} | - | - | -0.2 | μA | V _{th} =0V | Fig.23 |
| MIN input bias current | I _{min} | - | - | -0.2 | μA | V _{min} =0V | Fig.24 |
| CS input bias current | I _{cs} | - | - | -0.2 | μA | V _{cs} =0V | Fig.25 |
| LZST input bias current | I _{lzst} | - | - | -1.0 | μA | V _{lzst} =0V | Fig.26 |

About a current item, define the inflow current to IC as a positive notation, and the outflow current from IC as a negative notation.

● Typical performance curves(Reference data)

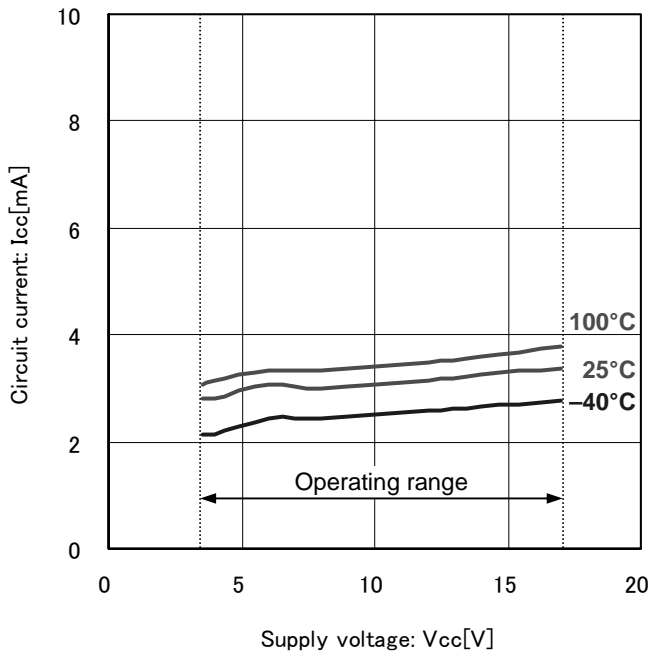

Fig.3 Circuit current

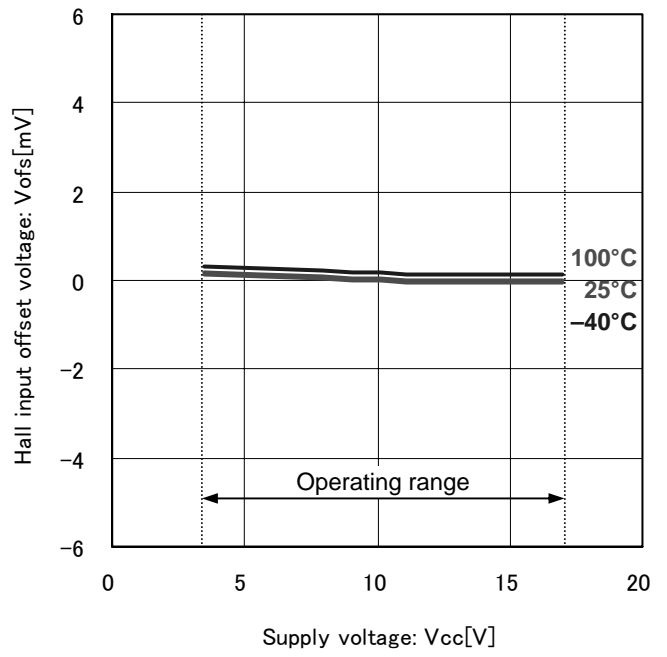

Fig.4 Hall input offset voltage

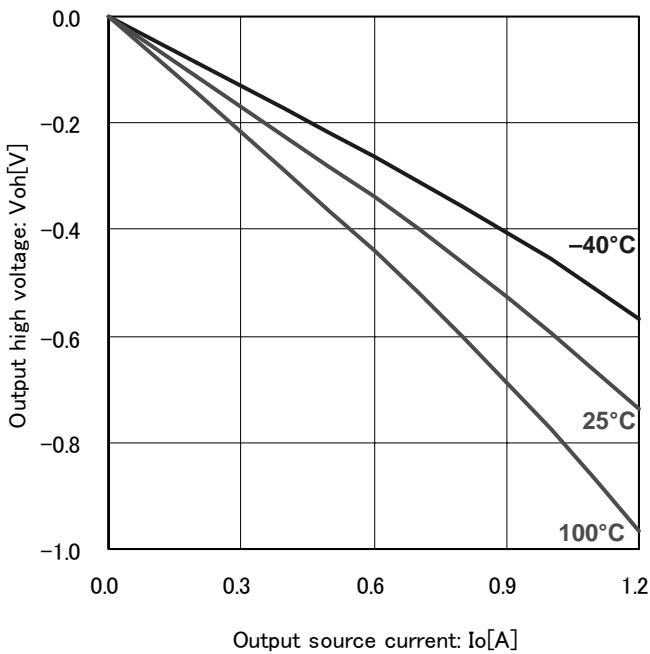

Fig.5 Output high voltage ($V_{cc}=12V$)

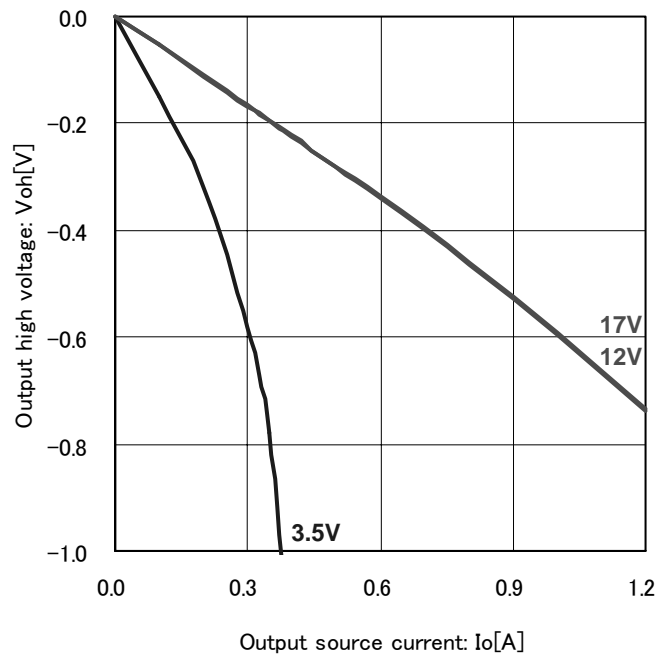

Fig.6 Output high voltage ($T_a=25^\circ C$)

● Typical performance curves(Reference data)

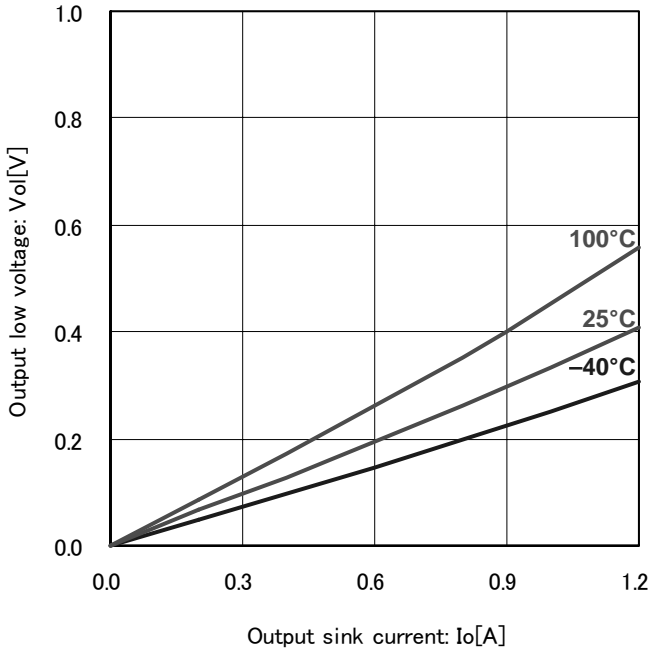

Fig.7 Output low voltage (V_{CC}=12V)

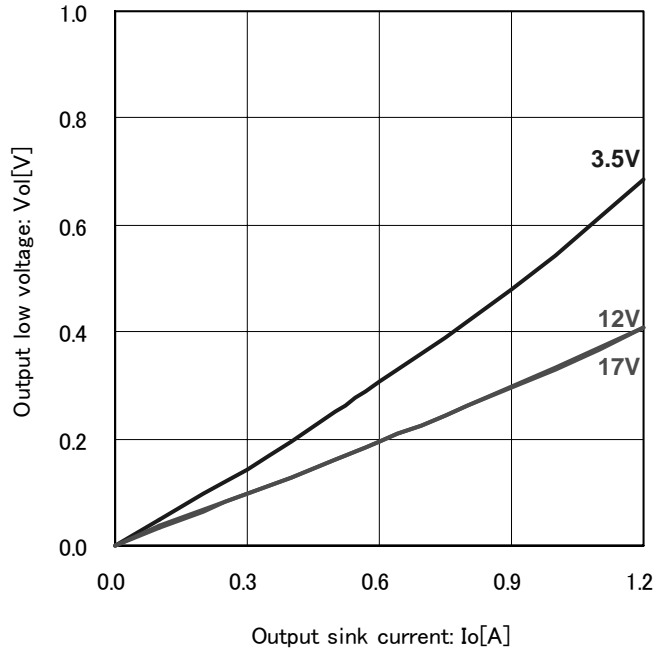

Fig.8 Output low voltage (T_a=25°C)

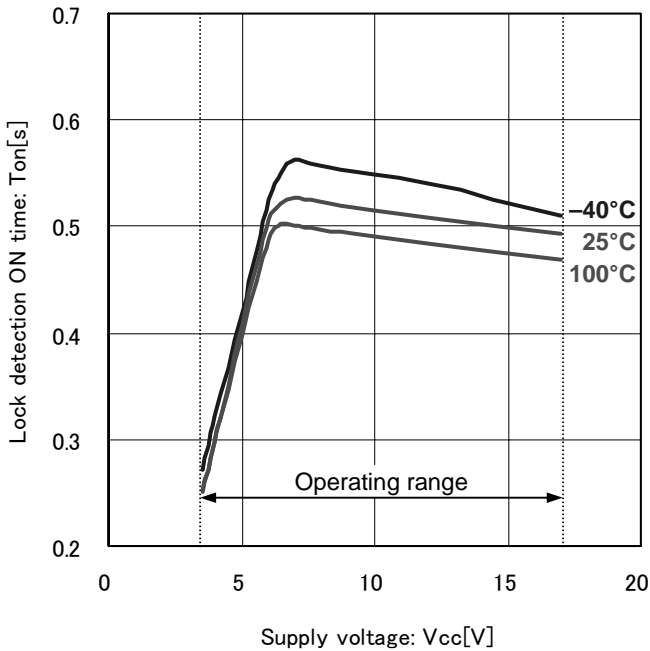

Fig.9 Lock detection ON time

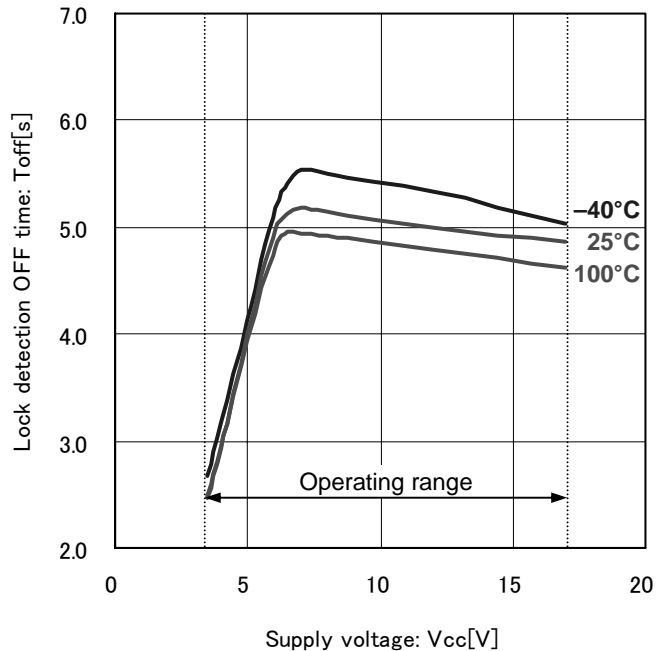

Fig.10 Lock detection OFF time

● Typical performance curves(Reference data)

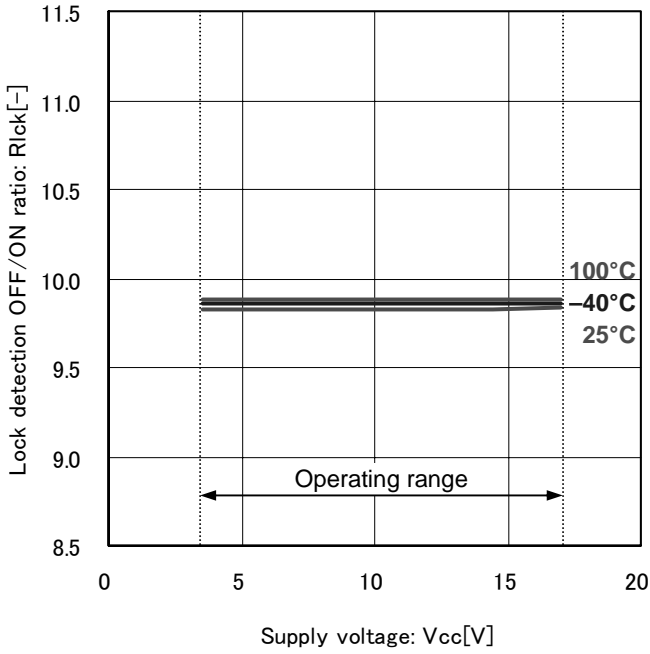

Fig.11 Lock detection OFF/ON ratio

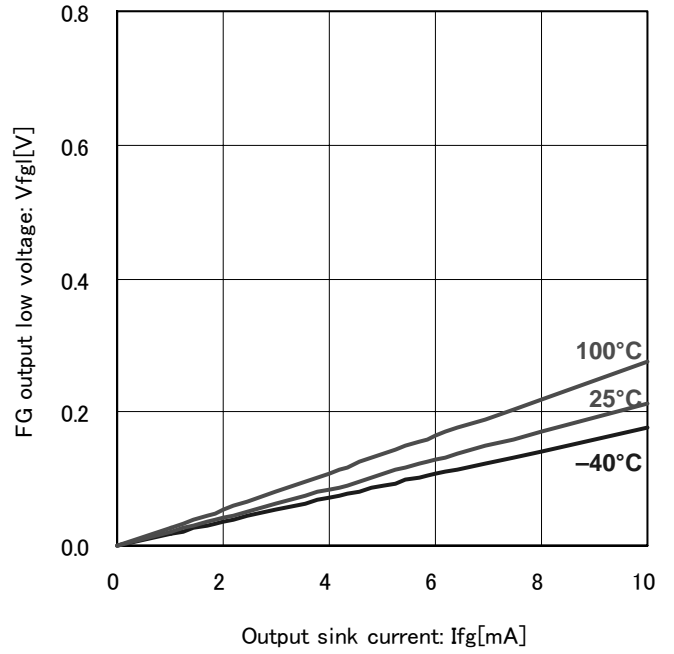

Fig.12 FG output low voltage (V_{cc}=12V)

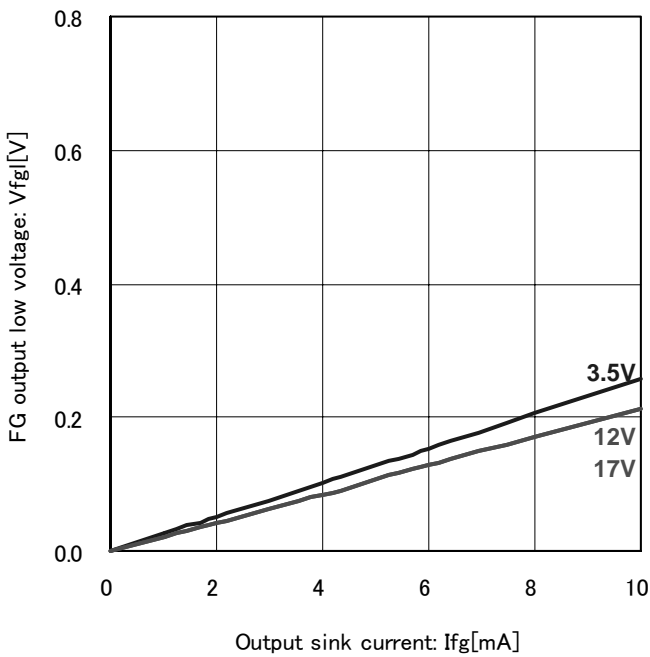

Fig.13 FG output low voltage (T_a=25°C)

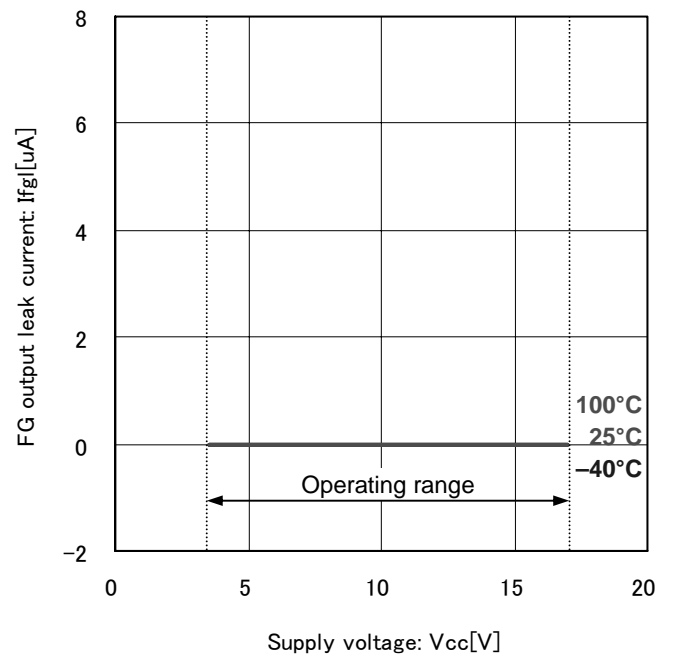

Fig.14 FG output leak current

● Typical performance curves(Reference data)

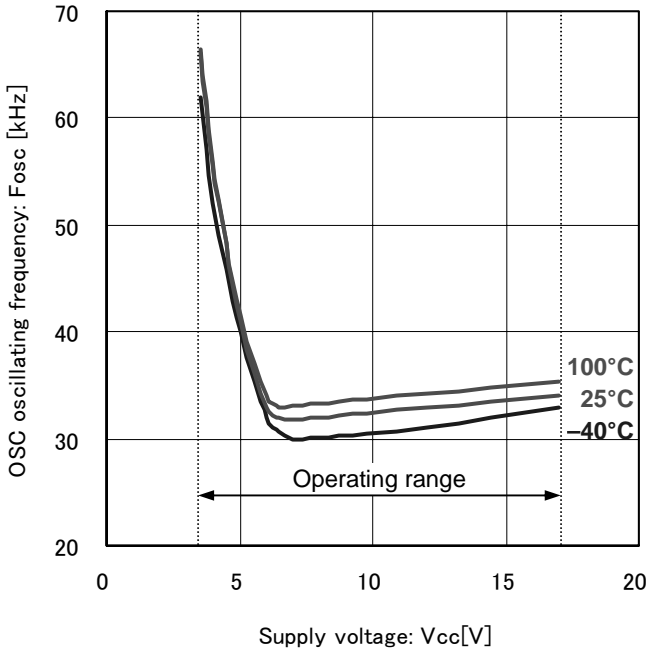

Fig.15 OSC oscillating frequency

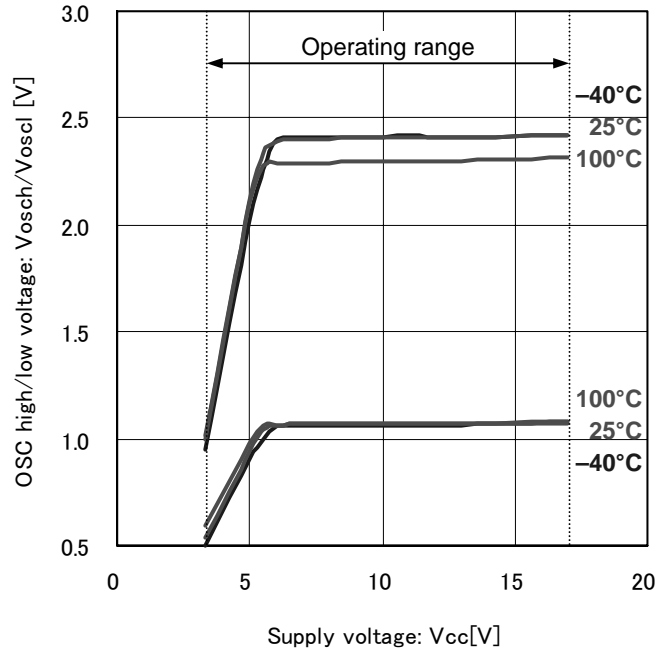

Fig.16 OSC high/low voltage

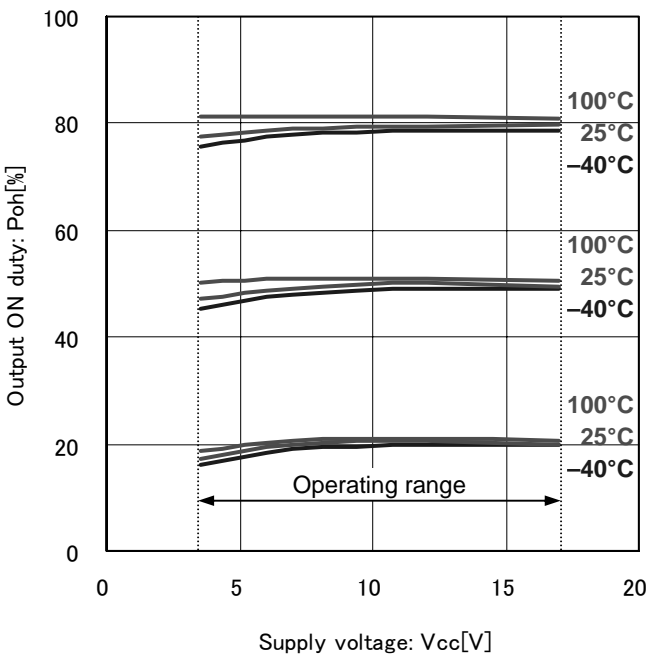

Fig.17 Output ON duty

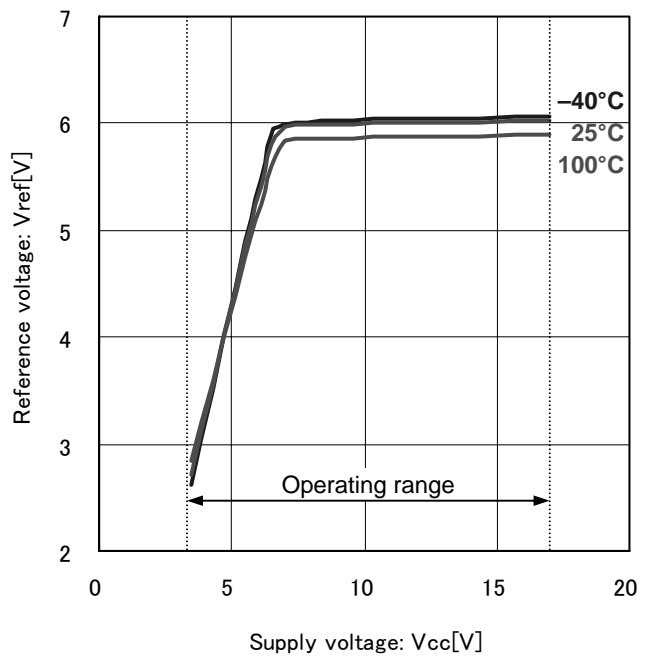

Fig.18 Reference voltage

● Typical performance curves(Reference data)

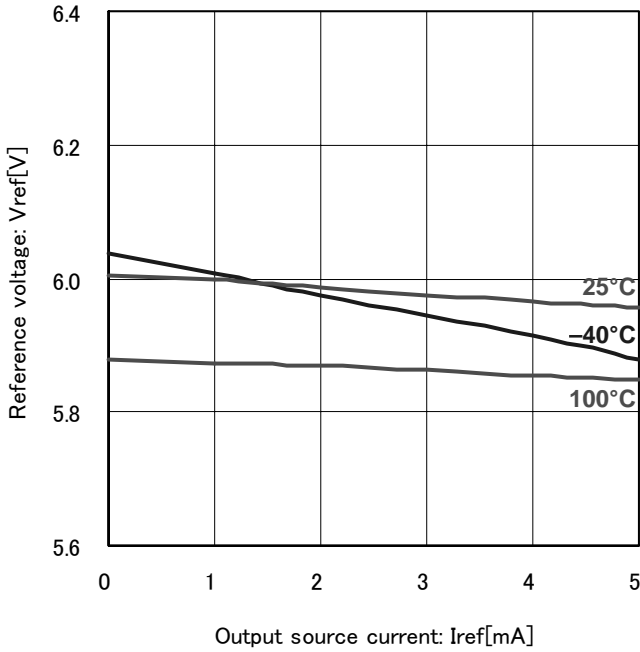

Fig.19 Reference voltage current ability ($V_{cc}=12V$)

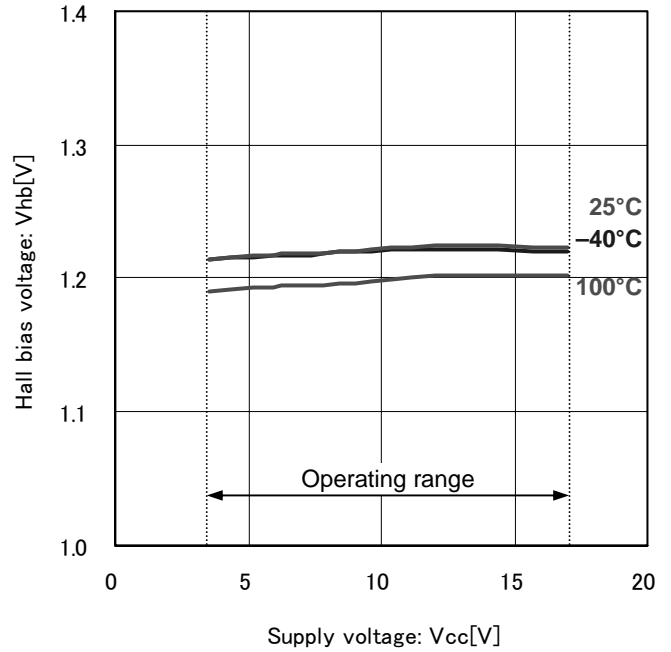

Fig.20 Hall bias voltage

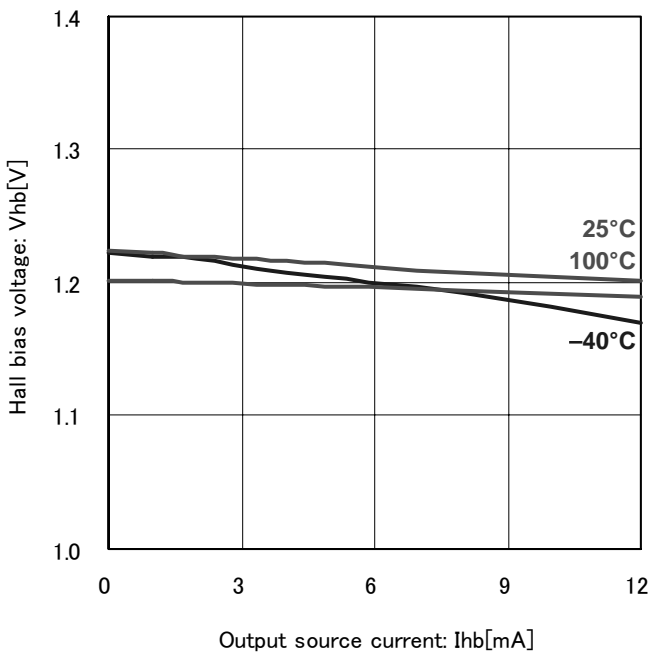

Fig.21 Hall bias voltage current ability ($V_{cc}=12V$)

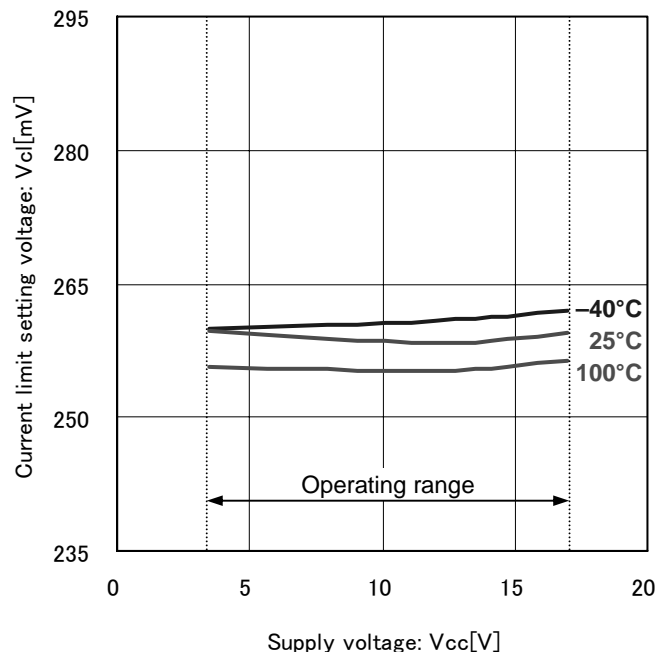

Fig.22 Current limit setting voltage

● Typical performance curves(Reference data)

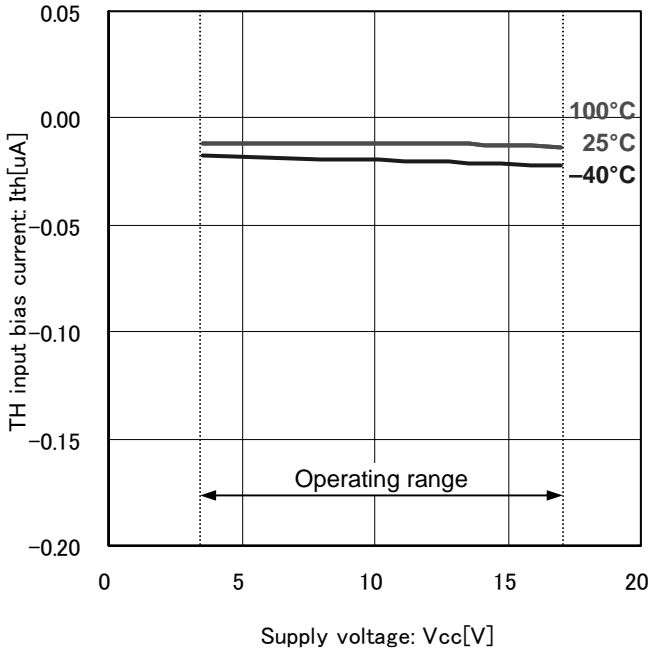

Fig.23 TH input bias current

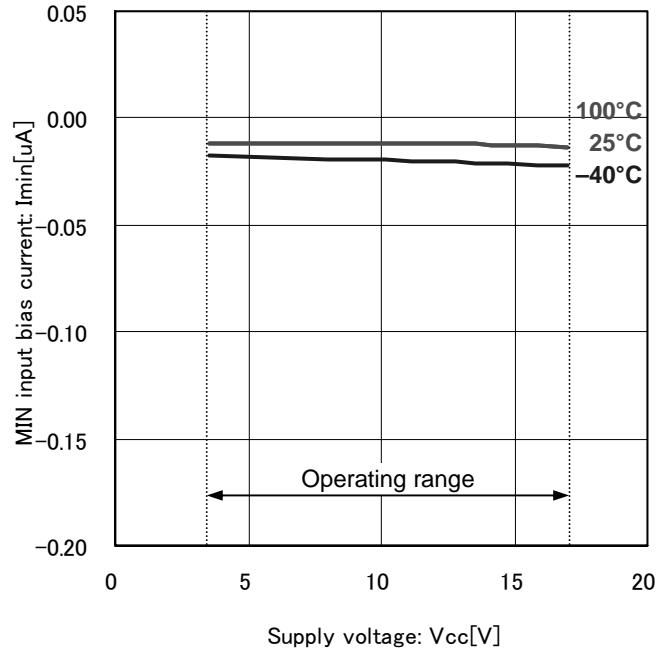

Fig.24 MIN input bias current

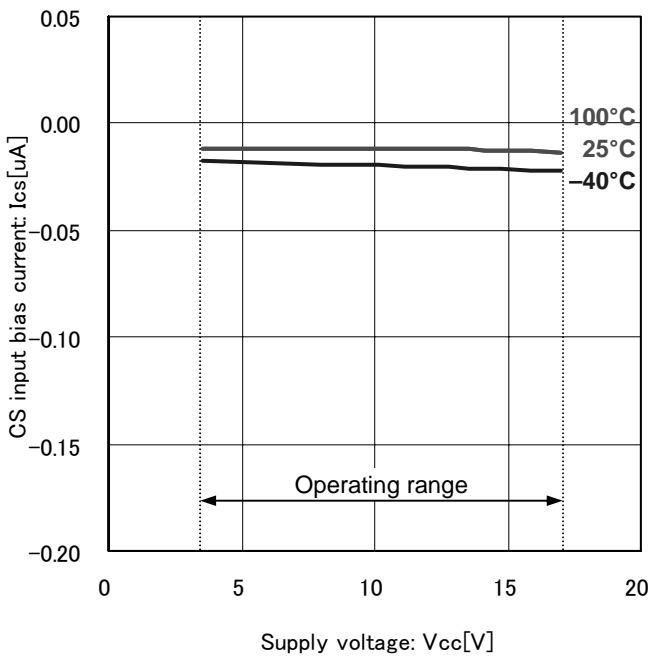

Fig.25 CS input bias current

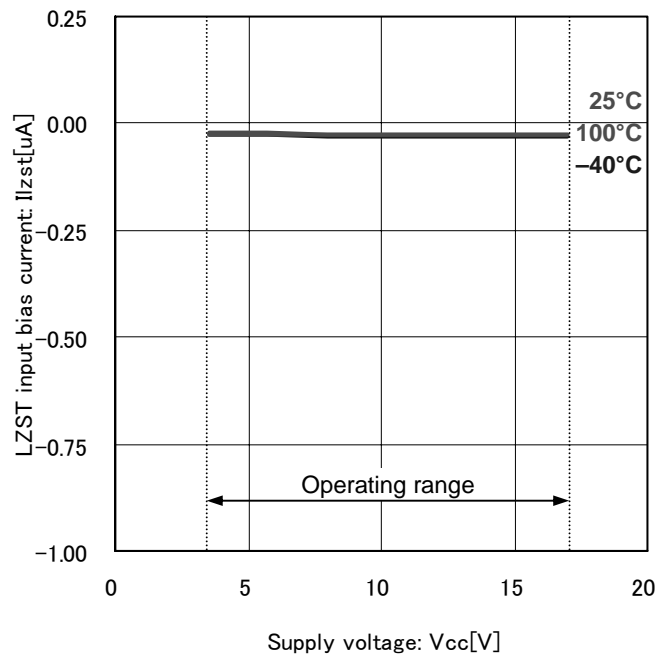

Fig.26 LZST input bias current

●Application circuit example(Constant values are for reference)

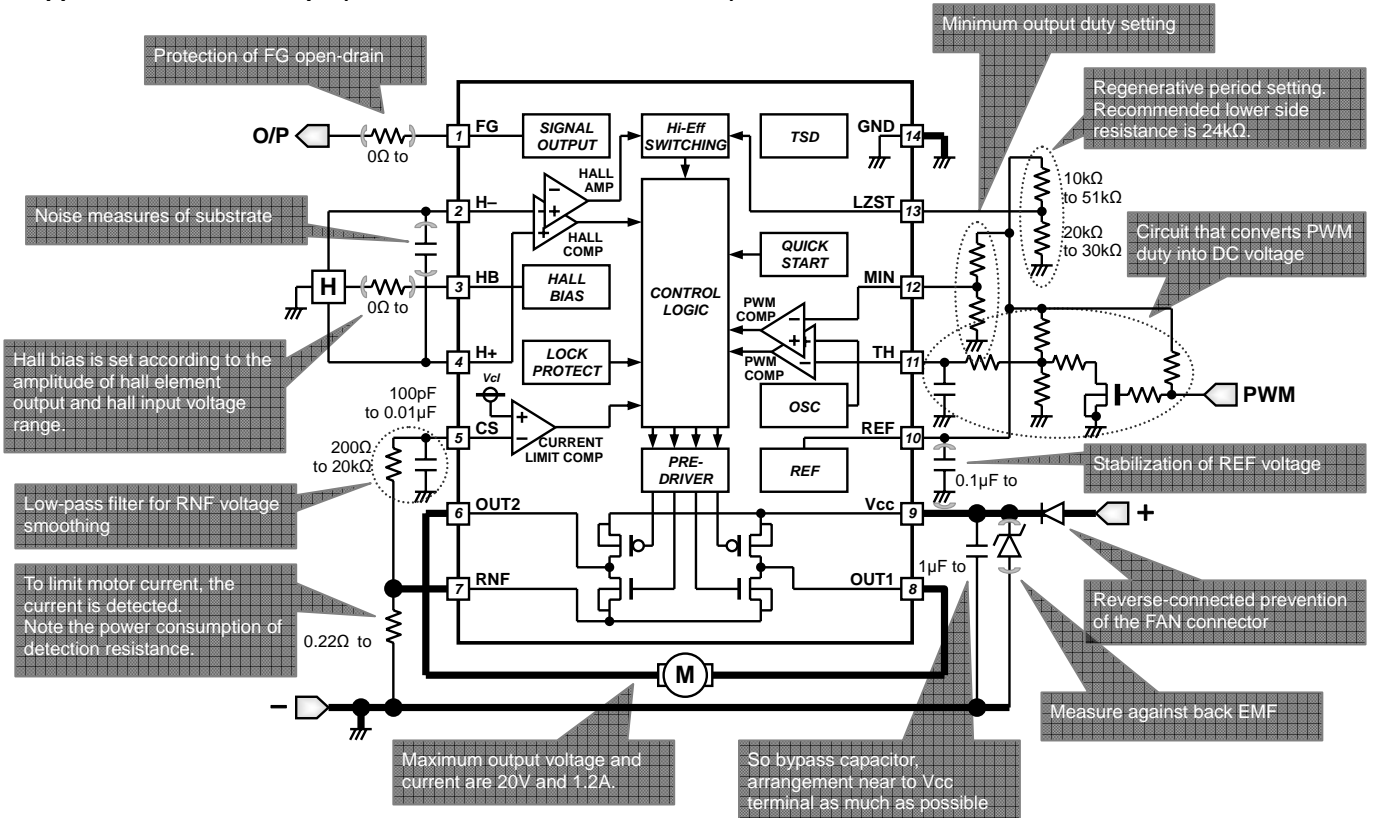

Fig.27 Application of converting PWM duty to DC voltage

Substrate design note

- IC power, motor outputs, and motor ground lines are made as fat as possible.
- IC ground (signal ground) line is common with the application ground except motor ground (i.e. hall ground etc.), and arranged near to (-) land.
- The bypass capacitor and/or Zenner diode are arrangement near to Vcc terminal.
- H+ and H- lines are arranged side by side and made from the hall element to IC as shorter as possible, because it is easy for the noise to influence the hall lines.

●Power dissipation

Power dissipation (total loss) indicates the power that can be consumed by IC at Ta=25°C (normal temperature). IC is heated when it consumes power, and the temperature of IC chip becomes higher than ambient temperature. The temperature that can be accepted by IC chip depends on circuit configuration, manufacturing process, etc, and consumable power is limited. Power dissipation is determined by the temperature allowed in IC chip (maximum junction temperature) and thermal resistance of package (heat dissipation capability). The maximum junction temperature is in general equal to the maximum value in the storage temperature range.

Heat generated by consumed power of IC is radiated from the mold resin or lead frame of package. The parameter which indicates this heat dissipation capability (hardness of heat release) is called heat resistance, represented by the symbol θ_{ja} [°C/W]. This heat resistance can estimate the temperature of IC inside the package. Fig.28 shows the model of heat resistance of the package. Heat resistance θ_{ja} , ambient temperature Ta, junction temperature Tj, and power consumption P can be calculated by the equation below:

$$\theta_{ja} = (T_j - T_a) / P \text{ [°C/W]}$$

Thermal de-rating curve indicates power that can be consumed by IC with reference to ambient temperature. Power that can be consumed by IC begins to attenuate at certain ambient temperature. This gradient is determined by thermal resistance θ_{ja} . Thermal resistance θ_{ja} depends on chip size, power consumption, package ambient temperature, packaging condition, wind velocity, etc., even when the same package is used. Thermal de-rating curve indicates a reference value measured at a specified condition. Fig.29 shows a thermal de-rating curve (Value when mounting FR4 glass epoxy board 70[mm] x 70[mm] x 1.6[mm] (copper foil area below 3[%])). Thermal resistance θ_{jc} from IC chip joint part to the package surface part of mounting the above-mentioned same substrate is shown in the following as a reference value.

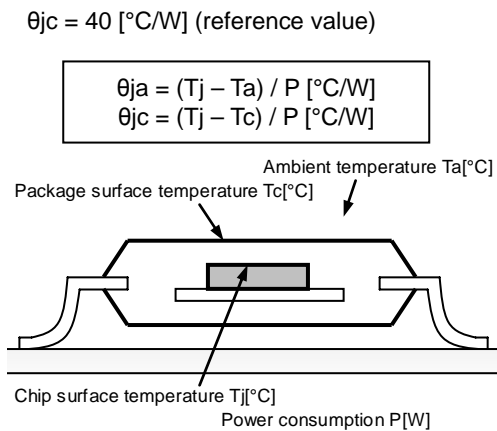

Fig.28 Thermal resistance

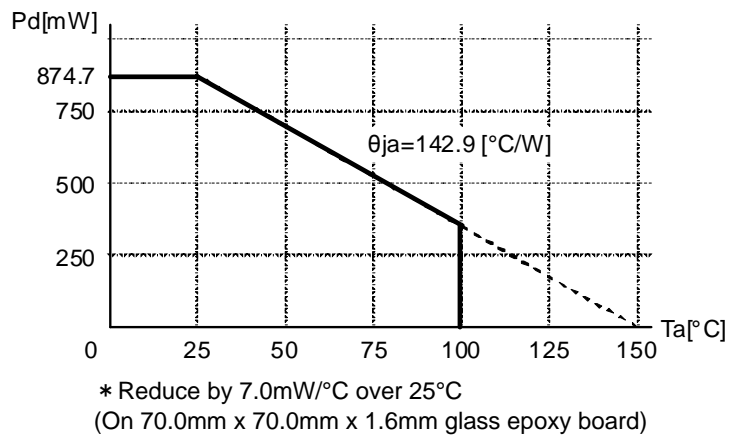
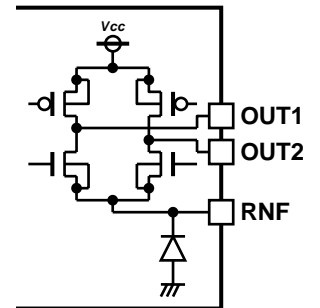
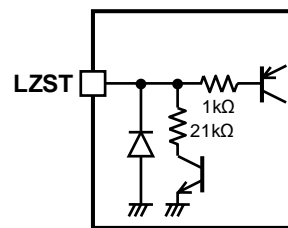
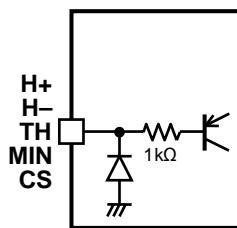
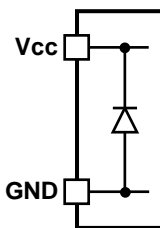

Fig.29 Thermal de-rating curve

●I/O equivalence circuit(Resistance values are typical)

- 1) Power supply terminal, and Ground terminal
- 2) Hall input terminals, Output duty controllable input terminal, Minimum output duty setting terminal, and Output current detection terminal
- 3) Regenerative period setting terminal
- 4) Motor output terminals, and Output current detecting resistor connecting terminal



- 5) Reference voltage output terminal, and Hall bias terminal

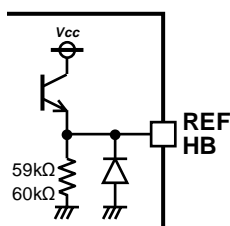

- 6) Speed pulse signal output terminal

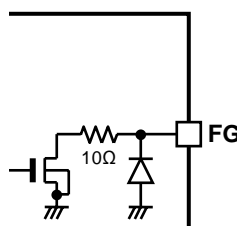

●Operational Notes

- 1) Absolute maximum ratings
An excess in the absolute maximum ratings, such as supply voltage, temperature range of operating conditions, etc., can break down the devices, thus making impossible to identify breaking mode, such as a short circuit or an open circuit. If any over rated values will expect to exceed the absolute maximum ratings, consider adding circuit protection devices, such as fuses.
- 2) Connecting the power supply connector backward
Connecting of the power supply in reverse polarity can damage IC. Take precautions when connecting the power supply lines. An external direction diode can be added.
- 3) Power supply line
Back electromotive force causes regenerated current to power supply line, therefore take a measure such as placing a capacitor between power supply and GND for routing regenerated current. And fully ensure that the capacitor characteristics have no problem before determine a capacitor value. (When applying electrolytic capacitors, capacitance characteristic values are reduced at low temperatures)
- 4) GND potential
It is possible that the motor output terminal may deflect below GND terminal because of influence by back electromotive force of motor. The potential of GND terminal must be minimum potential in all operating conditions, except that the levels of the motor outputs terminals are under GND level by the back electromotive force of the motor coil. Also ensure that all terminals except GND and motor output terminals do not fall below GND voltage including transient characteristics. Malfunction may possibly occur depending on use condition, environment, and property of individual motor. Please make fully confirmation that no problem is found on operation of IC.
- 5) Thermal design
Use a thermal design that allows for a sufficient margin in light of the power dissipation (Pd) in actual operating conditions.
- 6) Inter-pin shorts and mounting errors
Use caution when positioning the IC for mounting on printed circuit boards. The IC may be damaged if there is any connection error or if pins are shorted together.
- 7) Actions in strong electromagnetic field
Use caution when using the IC in the presence of a strong electromagnetic field as doing so may cause the IC to malfunction.
- 8) ASO
When using the IC, set the output transistor so that it does not exceed absolute maximum ratings or ASO.
- 9) Thermal shut down circuit
The IC incorporates a built-in thermal shutdown circuit (TSD circuit). Operation temperature is 175°C (typ.) and has a hysteresis width of 25°C (typ.). When IC chip temperature rises and TSD circuit works, the output terminal becomes an open state. TSD circuit is designed only to shut the IC off to prevent thermal runaway. It is not designed to protect the IC or guarantee its operation. Do not continue to use the IC after operation this circuit or use the IC in an environment where the operation of this circuit is assumed.
- 10) Testing on application boards
When testing the IC on an application board, connecting a capacitor to a pin with low impedance subjects the IC to stress. Always discharge capacitors after each process or step. Always turn the IC's power supply off before connecting it to or removing it from a jig or fixture during the inspection process. Ground the IC during assembly steps as an antistatic measure. Use similar precaution when transporting or storing the IC.
- 11) GND wiring pattern
When using both small signal and large current GND patterns, it is recommended to isolate the two ground patterns, placing a single ground point at the ground potential of application so that the pattern wiring resistance and voltage variations caused by large currents do not cause variations in the small signal ground voltage. Be careful not to change the GND wiring pattern of any external components, either.
- 12) Capacitor between output and GND
When a large capacitor is connected between output and GND, if Vcc is shorted with 0V or GND for some cause, it is possible that the current charged in the capacitor may flow into the output resulting in destruction. Keep the capacitor between output and GND below 100μF.
- 13) IC terminal input
When Vcc voltage is not applied to IC, do not apply voltage to each input terminal. When voltage above Vcc or below GND is applied to the input terminal, parasitic element is actuated due to the structure of IC. Operation of parasitic element causes mutual interference between circuits, resulting in malfunction as well as destruction in the last. Do not use in a manner where parasitic element is actuated.
- 14) In use
We are sure that the example of application circuit is preferable, but please check the character further more in application to a part that requires high precision. In using the unit with external circuit constant changed, consider the variation of externally equipped parts and our IC including not only static character but also transient character and allow sufficient margin in determining.

●Status of this document

The Japanese version of this document is formal specification. A customer may use this translation version only for a reference to help reading the formal version.

If there are any differences in translation version of this document, formal version takes priority.

●Physical dimension tape and reel information

SSOP-B14

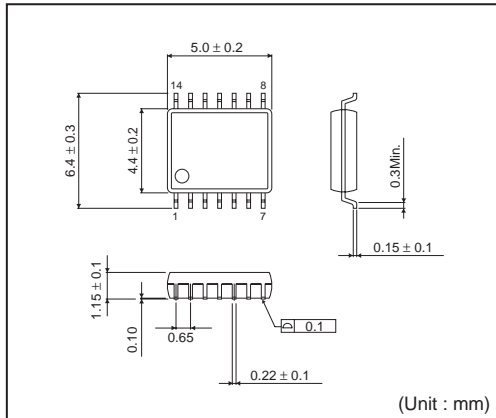

<Tape and Reel information>

| | |
|-------------------|---|
| Tape | Embossed carrier tape |
| Quantity | 2500pcs |
| Direction of feed | E2 (The direction is the 1pin of product is at the upper left when you hold reel on the left hand and you pull out the tape on the right hand) |

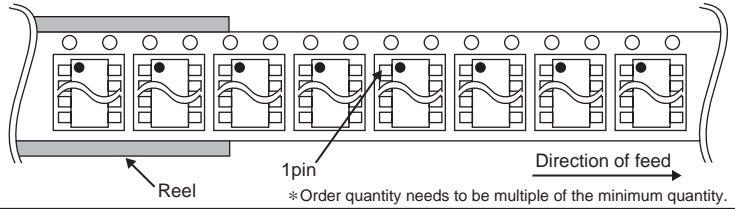

●Marking diagram

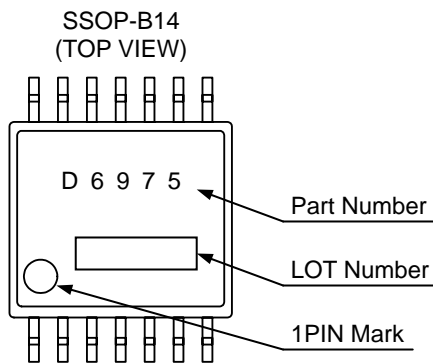

●Revision history

| Date | Revision | Comments |
|-------------|----------|--|
| 07.JUL.2012 | 001 | New Release |
| 28.JUL.2012 | 002 | Color appearance change (There is no change in the content.) |
| | | |

Notice

Precaution on using ROHM Products

- Our Products are designed and manufactured for application in ordinary electronic equipments (such as AV equipment, OA equipment, telecommunication equipment, home electronic appliances, amusement equipment, etc.). If you intend to use our Products in devices requiring extremely high reliability (such as medical equipment ^(Note 1), transport equipment, traffic equipment, aircraft/spacecraft, nuclear power controllers, fuel controllers, car equipment including car accessories, safety devices, etc.) and whose malfunction or failure may cause loss of human life, bodily injury or serious damage to property ("Specific Applications"), please consult with the ROHM sales representative in advance. Unless otherwise agreed in writing by ROHM in advance, ROHM shall not be in any way responsible or liable for any damages, expenses or losses incurred by you or third parties arising from the use of any ROHM's Products for Specific Applications.

(Note1) Medical Equipment Classification of the Specific Applications

| JAPAN | USA | EU | CHINA |
|-----------|-----------|------------|-----------|
| CLASS III | CLASS III | CLASS II b | CLASS III |
| CLASS IV | | CLASS III | |

- ROHM designs and manufactures its Products subject to strict quality control system. However, semiconductor products can fail or malfunction at a certain rate. Please be sure to implement, at your own responsibilities, adequate safety measures including but not limited to fail-safe design against the physical injury, damage to any property, which a failure or malfunction of our Products may cause. The following are examples of safety measures:
 - Installation of protection circuits or other protective devices to improve system safety
 - Installation of redundant circuits to reduce the impact of single or multiple circuit failure
- Our Products are designed and manufactured for use under standard conditions and not under any special or extraordinary environments or conditions, as exemplified below. Accordingly, ROHM shall not be in any way responsible or liable for any damages, expenses or losses arising from the use of any ROHM's Products under any special or extraordinary environments or conditions. If you intend to use our Products under any special or extraordinary environments or conditions (as exemplified below), your independent verification and confirmation of product performance, reliability, etc. prior to use, must be necessary:
 - Use of our Products in any types of liquid, including water, oils, chemicals, and organic solvents
 - Use of our Products outdoors or in places where the Products are exposed to direct sunlight or dust
 - Use of our Products in places where the Products are exposed to sea wind or corrosive gases, including Cl₂, H₂S, NH₃, SO₂, and NO₂
 - Use of our Products in places where the Products are exposed to static electricity or electromagnetic waves
 - Use of our Products in proximity to heat-producing components, plastic cords, or other flammable items
 - Sealing or coating our Products with resin or other coating materials
 - Use of our Products without cleaning residue of flux (even if you use no-clean type fluxes, cleaning residue of flux is recommended); or Washing our Products by using water or water-soluble cleaning agents for cleaning residue after soldering
 - Use of the Products in places subject to dew condensation
- The Products are not subject to radiation-proof design.
- Please verify and confirm characteristics of the final or mounted products in using the Products.
- In particular, if a transient load (a large amount of load applied in a short period of time, such as pulse. is applied, confirmation of performance characteristics after on-board mounting is strongly recommended. Avoid applying power exceeding normal rated power; exceeding the power rating under steady-state loading condition may negatively affect product performance and reliability.
- De-rate Power Dissipation (Pd) depending on Ambient temperature (Ta). When used in sealed area, confirm the actual ambient temperature.
- Confirm that operation temperature is within the specified range described in the product specification.
- ROHM shall not be in any way responsible or liable for failure induced under deviant condition from what is defined in this document.

Precaution for Mounting / Circuit board design

- When a highly active halogenous (chlorine, bromine, etc.) flux is used, the residue of flux may negatively affect product performance and reliability.
- In principle, the reflow soldering method must be used; if flow soldering method is preferred, please consult with the ROHM representative in advance.

For details, please refer to ROHM Mounting specification

Precautions Regarding Application Examples and External Circuits

1. If change is made to the constant of an external circuit, please allow a sufficient margin considering variations of the characteristics of the Products and external components, including transient characteristics, as well as static characteristics.
2. You agree that application notes, reference designs, and associated data and information contained in this document are presented only as guidance for Products use. Therefore, in case you use such information, you are solely responsible for it and you must exercise your own independent verification and judgment in the use of such information contained in this document. ROHM shall not be in any way responsible or liable for any damages, expenses or losses incurred by you or third parties arising from the use of such information.

Precaution for Electrostatic

This Product is electrostatic sensitive product, which may be damaged due to electrostatic discharge. Please take proper caution in your manufacturing process and storage so that voltage exceeding the Products maximum rating will not be applied to Products. Please take special care under dry condition (e.g. Grounding of human body / equipment / solder iron, isolation from charged objects, setting of ionizer, friction prevention and temperature / humidity control).

Precaution for Storage / Transportation

1. Product performance and soldered connections may deteriorate if the Products are stored in the places where:
 - [a] the Products are exposed to sea winds or corrosive gases, including Cl₂, H₂S, NH₃, SO₂, and NO₂
 - [b] the temperature or humidity exceeds those recommended by ROHM
 - [c] the Products are exposed to direct sunshine or condensation
 - [d] the Products are exposed to high Electrostatic
2. Even under ROHM recommended storage condition, solderability of products out of recommended storage time period may be degraded. It is strongly recommended to confirm solderability before using Products of which storage time is exceeding the recommended storage time period.
3. Store / transport cartons in the correct direction, which is indicated on a carton with a symbol. Otherwise bent leads may occur due to excessive stress applied when dropping of a carton.
4. Use Products within the specified time after opening a humidity barrier bag. Baking is required before using Products of which storage time is exceeding the recommended storage time period.

Precaution for Product Label

QR code printed on ROHM Products label is for ROHM's internal use only.

Precaution for Disposition

When disposing Products please dispose them properly using an authorized industry waste company.

Precaution for Foreign Exchange and Foreign Trade act

Since our Products might fall under controlled goods prescribed by the applicable foreign exchange and foreign trade act, please consult with ROHM representative in case of export.

Precaution Regarding Intellectual Property Rights

1. All information and data including but not limited to application example contained in this document is for reference only. ROHM does not warrant that foregoing information or data will not infringe any intellectual property rights or any other rights of any third party regarding such information or data. ROHM shall not be in any way responsible or liable for infringement of any intellectual property rights or other damages arising from use of such information or data.:
2. No license, expressly or implied, is granted hereby under any intellectual property rights or other rights of ROHM or any third parties with respect to the information contained in this document.

Other Precaution

1. This document may not be reprinted or reproduced, in whole or in part, without prior written consent of ROHM.
2. The Products may not be disassembled, converted, modified, reproduced or otherwise changed without prior written consent of ROHM.
3. In no event shall you use in any way whatsoever the Products and the related technical information contained in the Products or this document for any military purposes, including but not limited to, the development of mass-destruction weapons.
4. The proper names of companies or products described in this document are trademarks or registered trademarks of ROHM, its affiliated companies or third parties.

General Precaution

1. Before you use our Products, you are requested to carefully read this document and fully understand its contents. ROHM shall not be in any way responsible or liable for failure, malfunction or accident arising from the use of any ROHM's Products against warning, caution or note contained in this document.
2. All information contained in this document is current as of the issuing date and subject to change without any prior notice. Before purchasing or using ROHM's Products, please confirm the latest information with a ROHM sales representative.
3. The information contained in this document is provided on an "as is" basis and ROHM does not warrant that all information contained in this document is accurate and/or error-free. ROHM shall not be in any way responsible or liable for any damages, expenses or losses incurred by you or third parties resulting from inaccuracy or errors of or concerning such information.