

Specification for release

Customer : _____
 Ordercode: **82400152**
 Description: **TVS Diode Array WE-TVS**
 Package: **SOT563**



DATUM / DATE : 2014-05-07

A Features:

- ESD Protection for 2 high-speed I/O channels and VDD
- Provide ESD protection for each channel to IEC 61000-4-2 (ESD) $\pm 15\text{kV}$ (air), $\pm 8\text{kV}$ (contact) IEC 61000-4-4 (EFT) (5/50ns) 20A (I/O), 40A (VDD) IEC 61000-4-5 (Lightning) 6A (8/20 μs)
- Below 5V operating voltage: 2.5 - 3.3 - 4.2 - 5.0V
- Ultra Low capacitance: 2.0pF typical

Mechanical Characteristics:

- SOT563 Package
- Molding compound flamability rating: UL94V-0
- Packaging: Tape & Reel

B Schematic and Pin Configuration:

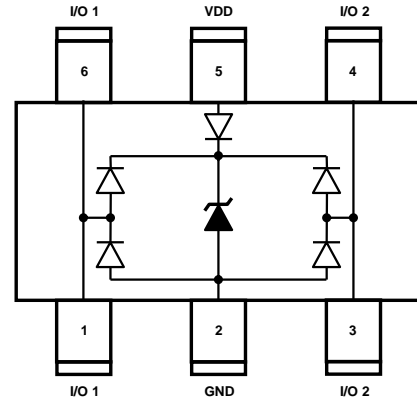

C Absolute Maximum Ratings:

	Symbol	Rating	Unit
Peak Pulse Current (tp = 8/20 μs)	I_{PP}	6	A
Operating Supply Voltage, VDD to GND	V_{DC}	6	V
ESD per IEC 61000-4-2 (Air / Contact), I/O to GND	$V_{ESD,IO}$	15 / 8	kV
ESD per IEC 61000-4-2 (Air / Contact), VDD to GND	$V_{ESD,VDD}$	15 / 8	kV
DC Voltage at any I/O Pin	V_{IO}	(GND -0,5) to (VDD +0,5)	V
Operating Temperature	T_{Op}	-40 to +125	$^{\circ}\text{C}$
Storage Temperature	T_{Sto}	-20 to +60	$^{\circ}\text{C}$

D Electrical Characteristics:

Properties	Test Conditions	Value min	Value typ	Value max	Unit
V_{RWM}	Pin 5 to Pin 2			5	V
V_{BV}	$I_{BV}=1\text{mA}$, Pin 5 to Pin 2	6.0			V
I_R	$V_{Pin5}=5\text{V}$, Pin 5 to Pin 2			5	μA
$I_{R,IO}$	$V_{Pin5}=5\text{V}$, $V_{Pin2}=0\text{V}$, I/O to GND			1	μA
V_F	$I_F = 15\text{mA}$, Pin 2 to Pin 5		0.8	1.0	V
V_C	$I_{pp}=5\text{A}$, tp=8/20 μs , I/O to GND		7.7		V
$V_{Cl,IO}$	$I_{TLP} = 17\text{A}$, I/O to GND		10.0		V
$V_{Cl,VDD}$	$I_{TLP} = 17\text{A}$, VDD to GND		9.2		V
C_{IO}	$V_{Pin5}=5\text{V}$, $V_{Pin2}=0\text{V}$, $V_{IO}=2.5\text{V}$, f=1MHz, I/O to GND		2.0	2.5	pF
C_X	$V_{Pin5}=5\text{V}$, $V_{Pin2}=0\text{V}$, $V_{IO}=2.5\text{V}$ f=1MHz, between I/O pins		0.4	0.6	pF

Würth Elektronik eiSos GmbH & Co. KG

D-74638 Waldenburg · Max-Eyth-Strasse 1 · Germany · Phone (+49) (0) 7942 - 945 - 0 · Fax (+49) (0) 7942 - 945 - 400

<http://www.we-online.com>

Specification for release

Customer : _____
 Ordercode: **82400152**
 Description : **TVS Diode Array WE-TVS**
 Package: **SOT563**



DATUM / DATE : 2014-05-07

E Typical Characteristics:

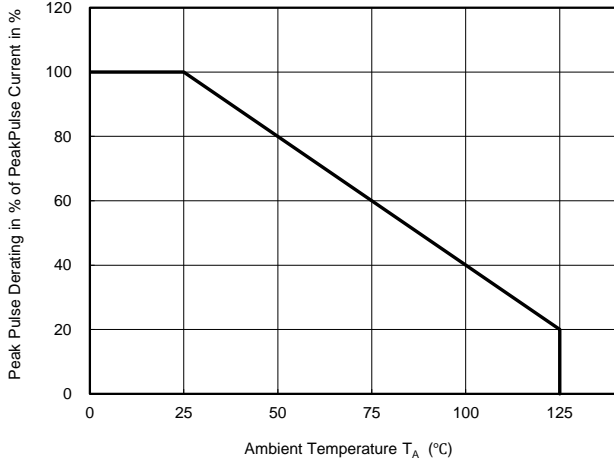

Power Derating Curve

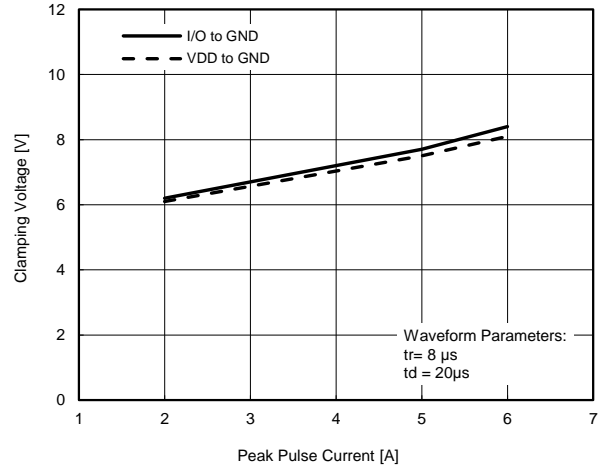

Clamping Voltage vs. Peak Pulse Current

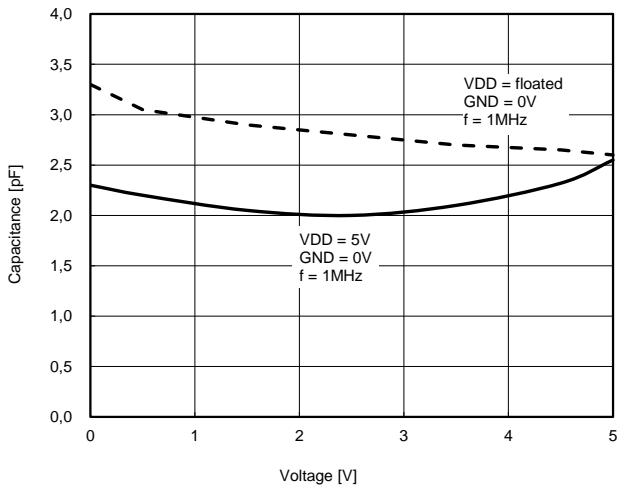

Variation of C_{IO} vs. V_{IO}

Specification for release

Customer : _____
 Ordercode: **82400152**
 Description : **TVS Diode Array WE-TVS**
 Package: **SOT563**



DATUM / DATE : 2014-05-07

E Typical Characteristic:

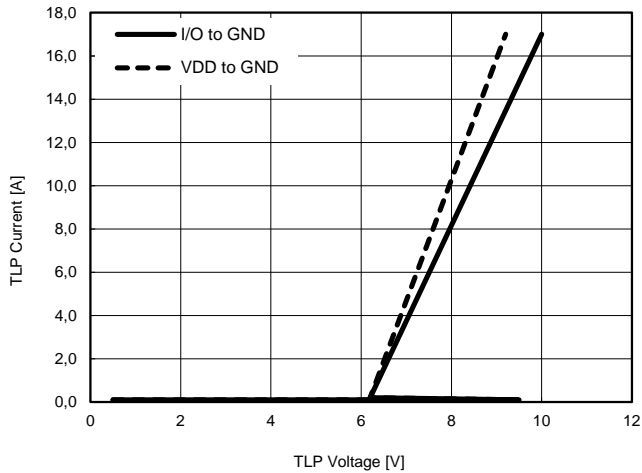

Transmission Line Pulsing (TLP) Measurement

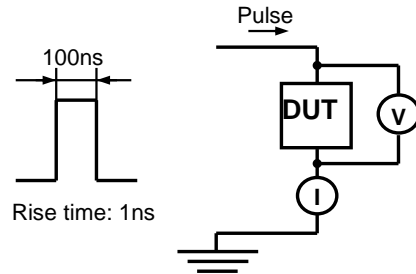

Transmission Line Pulsing System

F Recommended Land Layout:

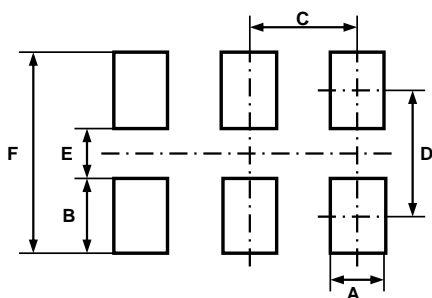

A	0.30	mm
B	0.5	mm
C	0.5	mm
D	1.4	mm
E	0.90	mm
F	1.90	mm

G Body Marking:

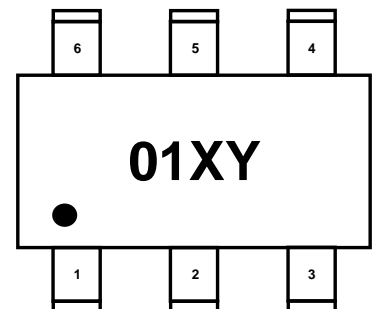

01: Device Code
 X: Date Code
 Y: Control Code

Würth Elektronik eiSos GmbH & Co. KG

D-74638 Waldenburg · Max-Eyth-Strasse 1 · Germany · Phone (+49) (0) 7942 - 945 - 0 · Fax (+49) (0) 7942 - 945 - 400

<http://www.we-online.com>

PAGE 3 OF 5

Specification for release

Customer : _____
Ordercode: **82400152**
Description : **TVS Diode Array WE-TVS**
Package: **SOT563**



DATUM / DATE : 2014-05-07

H Dimensions:

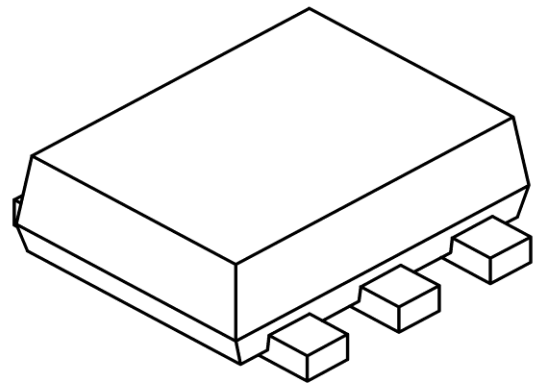
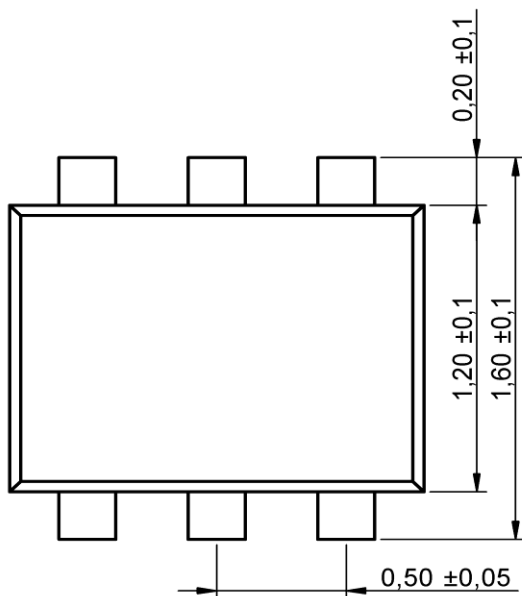
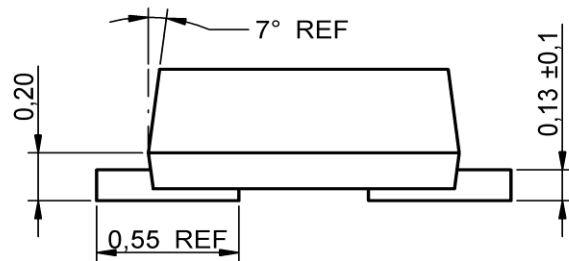
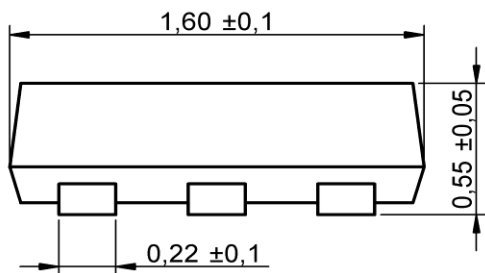

Scale - 20:1

Specification for release

Customer : _____
 Ordercode : **82400152**
 Description : **TVS Diode Array WE-TVS**
 Package : **SOT563**



I Tape:

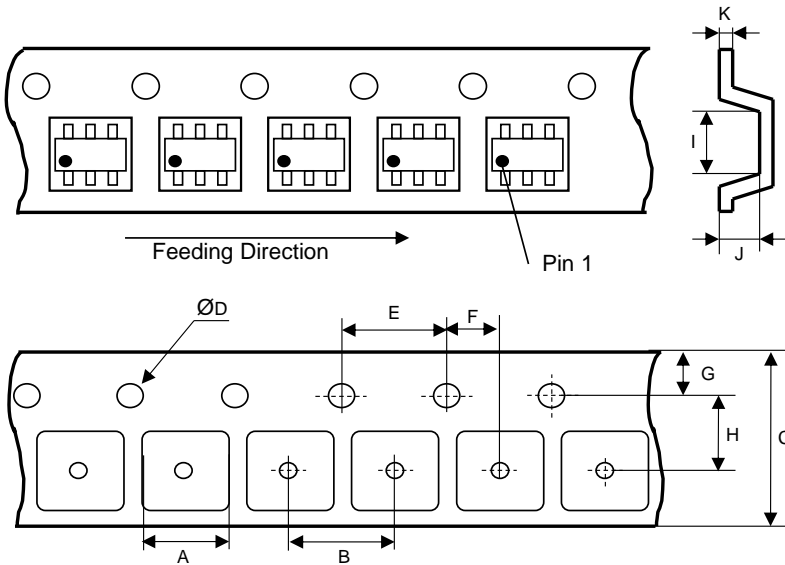

A	2.25 REF	mm
B	4.00 ± 0.10	mm
C	8.00 ± 0.20	mm
D	1.55 ± 0.05	mm
E	4.00 ± 0.10	mm
F	2.00 ± 0.05	mm
G	1.75 ± 0.10	mm
H	3.50 ± 0.05	mm
I	2.4 REF	mm
J	1.2 REF	mm
K	0.30 ± 0.02	mm

J Reel:

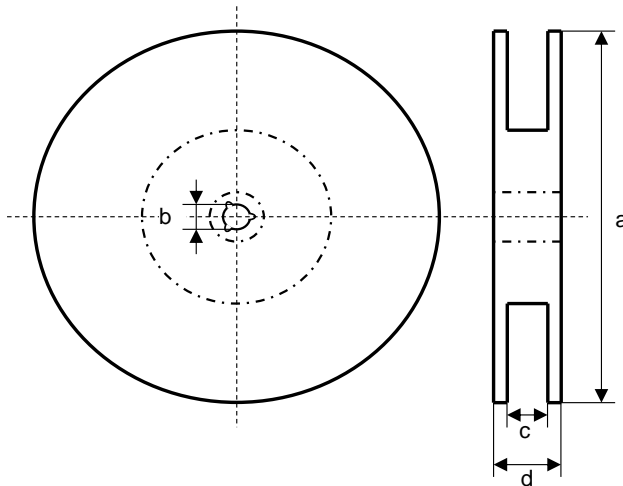

a	178.0 ± 2.0	mm
b	13.0 ± 0.8	mm
c	10.0 ± 1.5	mm
d	12.5 ± 2.0	mm

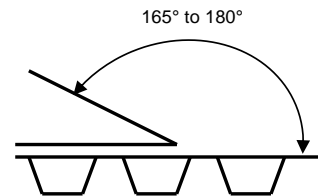

Quantity per Reel: 3000

General Release:	Customer		
Date	Signature		
	Würth Elektronik		
Checked	RoD	Change to Release	2014-05-07
	JB	Version 1	2010-01-27
	Name	Modification	Date
	Approved		

This electronic component has been designed and developed for usage in general electronic equipment. Before incorporating this component into any equipment where higher safety and reliability is especially required or if there is the possibility of direct damage or injury to human body, for example in the range of aerospace, aviation, nuclear control, submarine, transportation, (automotive control, train control, ship control), transportation signal, disaster prevention, medical, public information network etc, Würth Elektronik eiSos GmbH must be informed before the design-in stage. In addition, sufficient reliability evaluation checks for safety must be performed on every electronic component which is used in electrical circuits that require high safety and reliability functions or performance.

Würth Elektronik eiSos GmbH & Co. KG

D-74638 Waldenburg · Max-Eyth-Strasse 1 · Germany · Phone (+49) (0) 7942 - 945 - 0 · Fax (+49) (0) 7942 - 945 - 400

<http://www.we-online.com>