

Features

- 802.11a,n,ac Applications
- 0.9 dB T_X Insertion Loss
- 19 dB R_X Isolation
- 12 dB R_X Gain
- 2.2 dB Noise Figure
- 10 mA Current
- -40 dB EVM @ 23 dBm Input
(802.11ac 80 MHz / 256 QAM)
- Lead Free 2 mm 12-lead STQFN package
- RoHS* Compliant and 260°C Reflow Compatible

Description

The MAMF-010614 is a multi-function MMIC which includes a SPDT switch and LNA with bypass mode for the R_X path. This part would typically be used on the front end of WLAN 802.11a,n,ac modules where small size is critical.

The MAMF-010614 delivers high isolation between T_X and R_X paths, low T_X insertion loss and a high gain, low noise R_X path.

Ordering Information^{1,2}

Part Number	Package
MAMF-010614-TR3000	3000 piece reel
MAMF-010614-001SMB	Sample Board

1. Reference Application Note M513 for reel size information.
2. All sample boards include 5 loose parts.

Functional Schematic

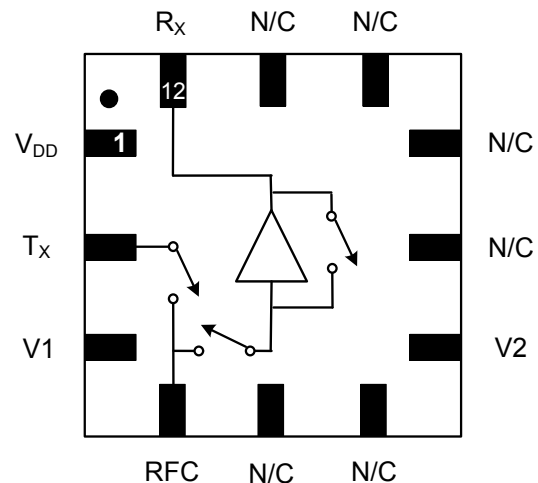

Pin Configuration³

Pin No.	Function	Description
1	V_{DD}	Drain Voltage Supply
2	T_X	T_X Port
3	V1	Control 1
4	RFC	RF Common
5	N/C	No Connection
6	N/C	No Connection
7	V2	Control 2
8	N/C	No Connection
9	N/C	No Connection
10	N/C	No Connection
11	N/C	No Connection
12	R_X	R_X Port
13	Paddle ⁴	Ground

3. M/A-COM Technology Solutions recommends connecting unused package pins to ground.
4. The exposed pad centered on the package bottom must be connected to RF and DC ground.

* Restrictions on Hazardous Substances, European Union Directive 2002/95/EC.

Integrated SPDT Switch and LNA with Bypass Mode 5.0 - 6.0 GHz

Rev. V4

Electrical Specifications: Freq. = 5.25 - 5.825 GHz, $V_{DD} = 3\text{ V}$, $V_C = 0/2.8\text{ V}$, $T_A = 25^\circ\text{C}$

Parameter	Test Conditions	Units	Min.	Typ.	Max.
Isolation	RFC to T_X RFC to R_X	dB	—	19 19	— —
T_X Insertion Loss	RFC to T_X	dB	—	0.9	1.2
T_X Input / Output Return Loss	RFC to T_X	dB	—	12	—
T_X Input P0.1dB	T_X Path On	dBm	—	31	—
T_X EVM	$P_{IN} = +23\text{ dBm}$, 802.11AC 80 MHz / 256 QAM	dB	—	-42	—
R_X Gain	RFC to R_X , Gain Mode	dB	10	12	—
R_X Insertion Loss	RFC to R_X , Bypass Mode	dB	—	6	7.5
R_X Input / Output Return Loss	RFC to R_X , Gain Mode	dB	—	10	—
R_X Noise Figure	Gain Mode	dB	—	2.2	—
R_X Input IP3	Gain Mode	dBm	—	10	—
R_X Input P0.1dB	Bypass Mode	dBm	—	10	—
R_X Input P1dB	Gain Mode	dBm	-5	-3	—
R_X EVM	$P_{IN} = -15\text{ dBm}$, Gain Mode	dB	—	-46	—
Quiescent Current	No RF, Gain Mode, $V_{DD} = 3\text{ V}$	mA	—	10	12
Leakage Current	All States except High Gain	μA	—	10	—

Absolute Maximum Ratings^{5,6}

Parameter	Absolute Maximum
Input Power R_X Gain Mode R_X Bypass Mode T_X , 5 V_C , RFC - T_X T_X , 3.3 V_C , RFC - T_X	0 dBm 20 dBm 35 dBm CW 33 dBm CW
V_{DD}	+5 volts
Operating Temperature	-40°C to +85°C
Storage Temperature	-65°C to +150°C

5. Exceeding any one or combination of these limits may cause permanent damage to this device.
6. M/A-COM Technology Solutions does not recommend sustained operation near these survivability limits.

Truth Table^{7,8}

Control V1	Control V2	RFC- R_X	RFC- T_X
Low	Low	Bypass Mode	Off
Hi	Low	Gain Mode	Off
Low	Hi	Off	On

7. Differential voltage, V (state Low) - V (state Hi), must be +2.7 V minimum and must not exceed +5 V.
8. Low = $0 \pm 0.3\text{ V}$, Hi = +2.7 V to +5 V.

Typical Performance Curves:

R_x Insertion Loss, Bypass Mode

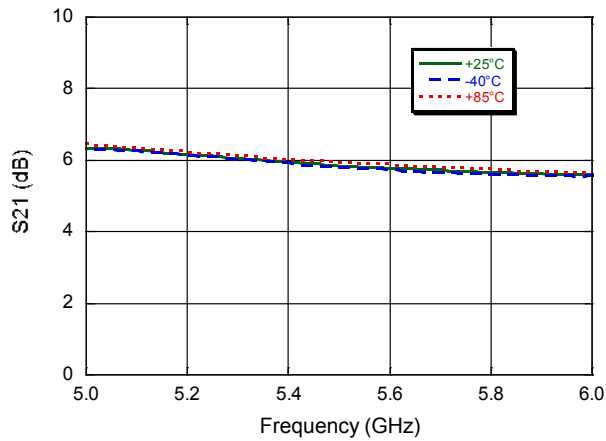

R_x Gain, Gain Mode

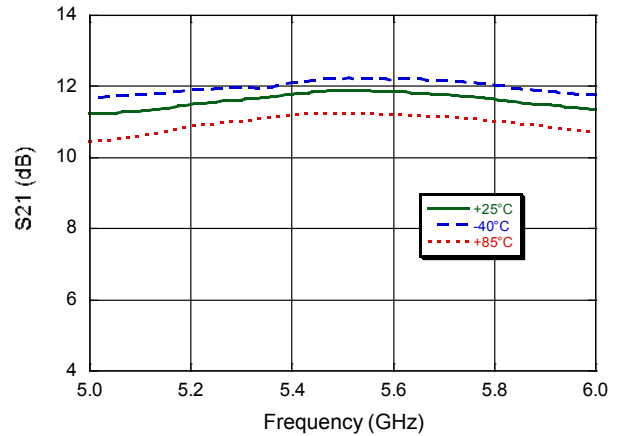

RFC - R_x Isolation (T_x On)

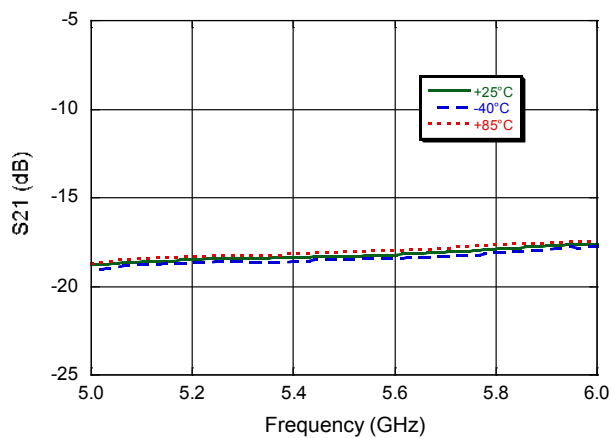

R_x Noise Figure, Gain Mode

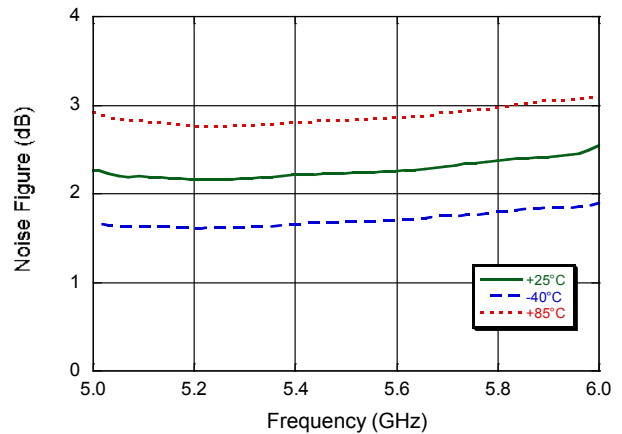

Typical Performance Curves:

R_x Input Return Loss, Bypass Mode

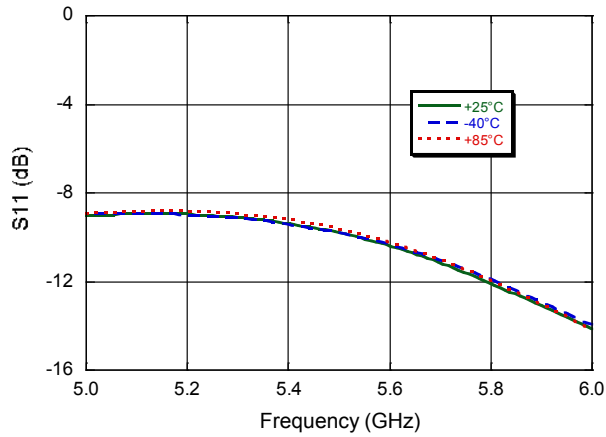

R_x Input Return Loss, Gain Mode

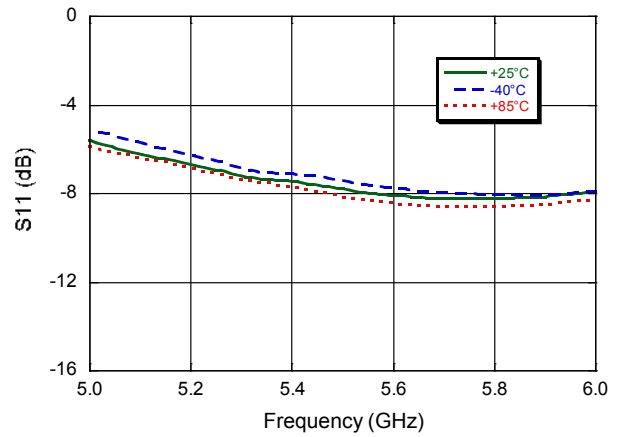

R_x Output Return Loss, Bypass Mode

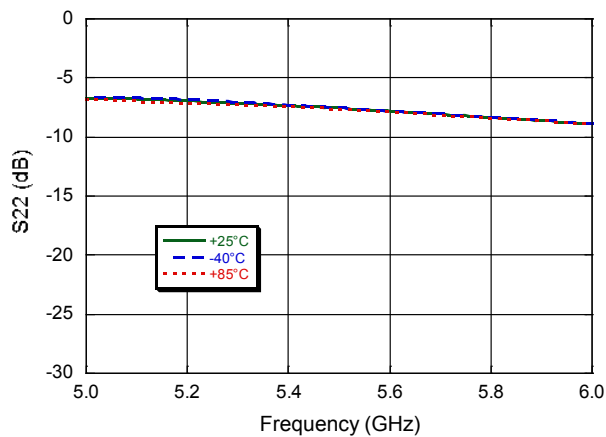

R_x Output Return Loss, Gain Mode

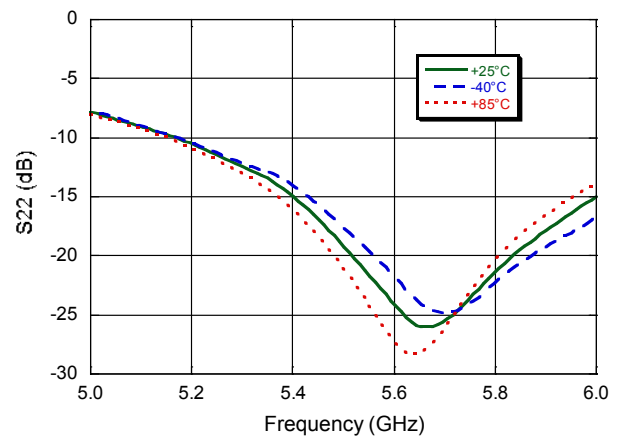

Integrated SPDT Switch and LNA with Bypass Mode 5.0 - 6.0 GHz

Rev. V4

Typical Performance Curves:

R_x Input IP₃, Gain Mode @ +25°C

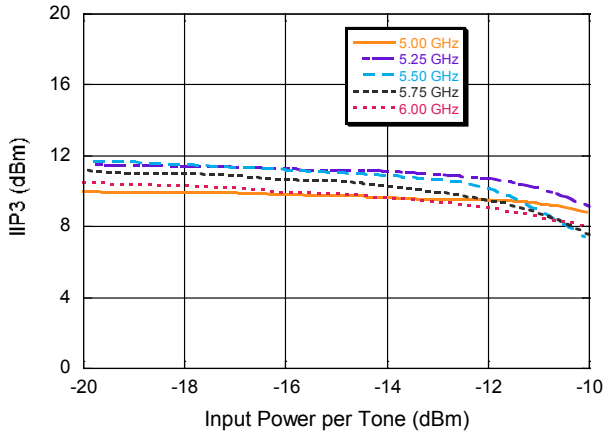

R_x Input IP₃, Bypass Mode @ +25°C

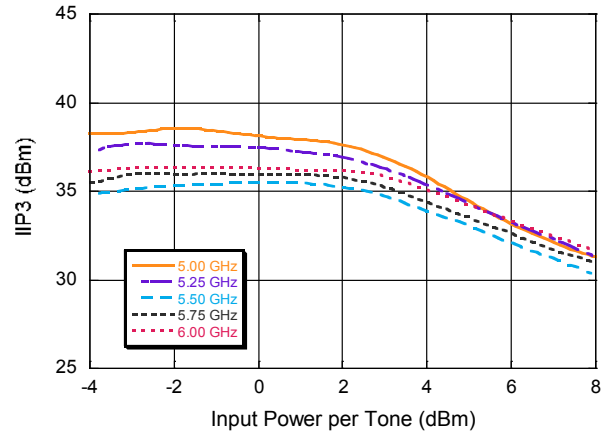

R_x Input IP₃, Gain Mode @ -40°C

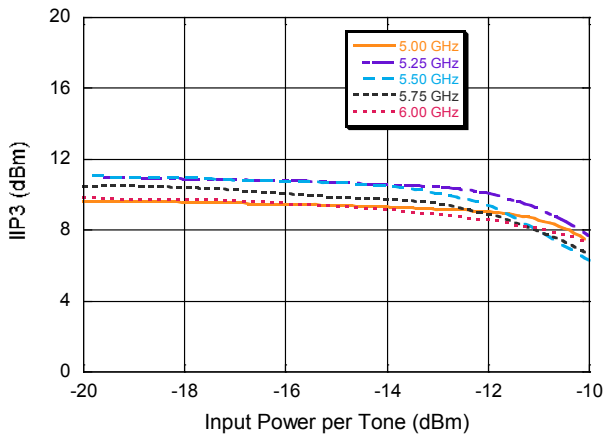

R_x Input IP₃, Bypass Mode @ -40°C

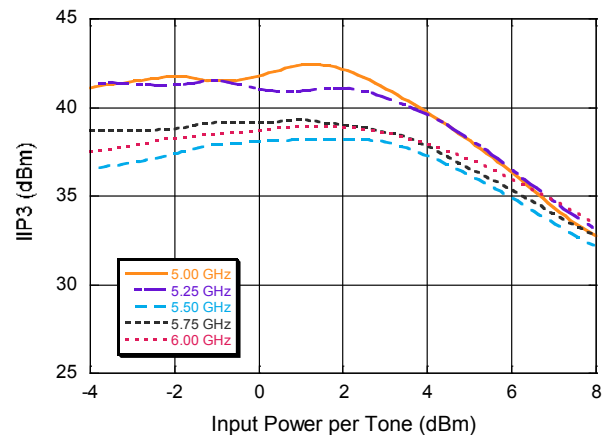

R_x Input IP₃, Gain Mode @ +85°C

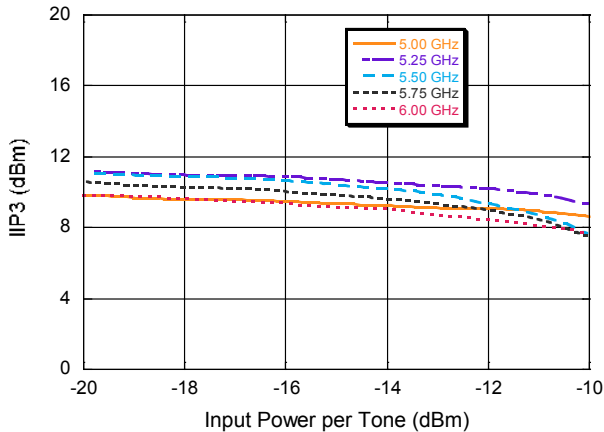

R_x Input IP₃, Bypass Mode @ +85°C

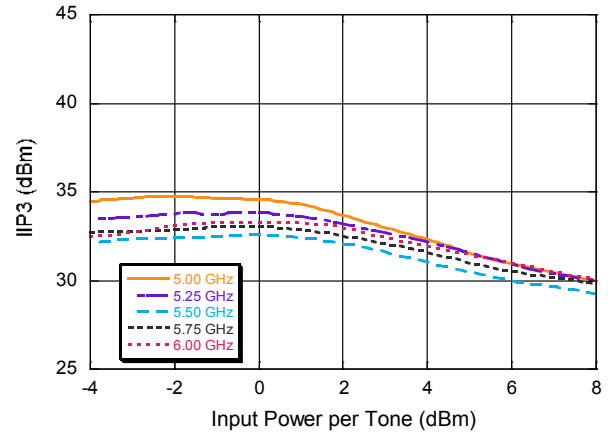

Typical Performance Curves:

T_x Input Return Loss

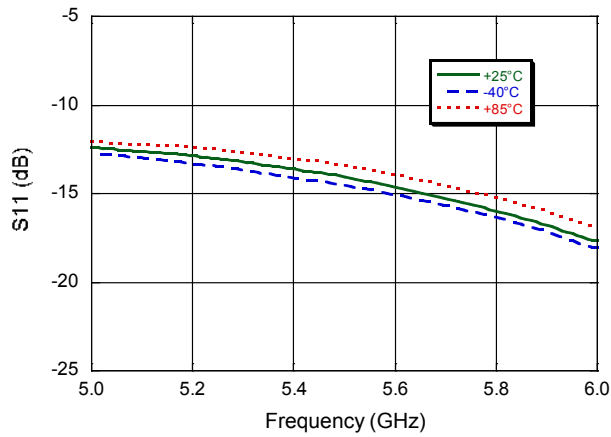

T_x Output Return Loss

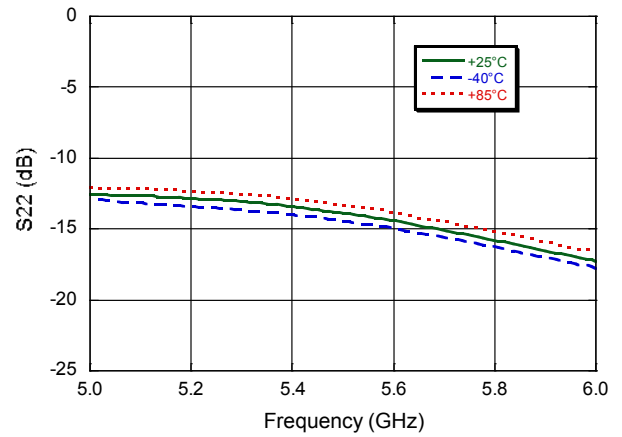

T_x Insertion Loss

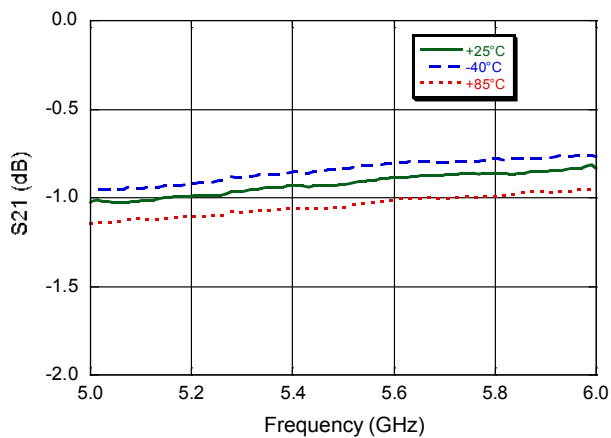

$T_x - R_x$ Isolation

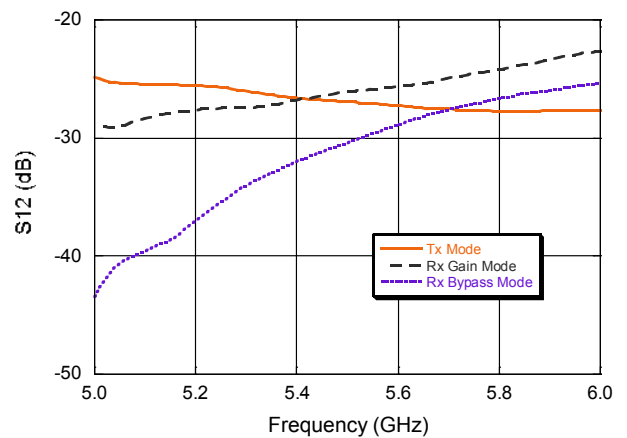

Typical Performance Curves:

T_x Input IP3 @ +25°C

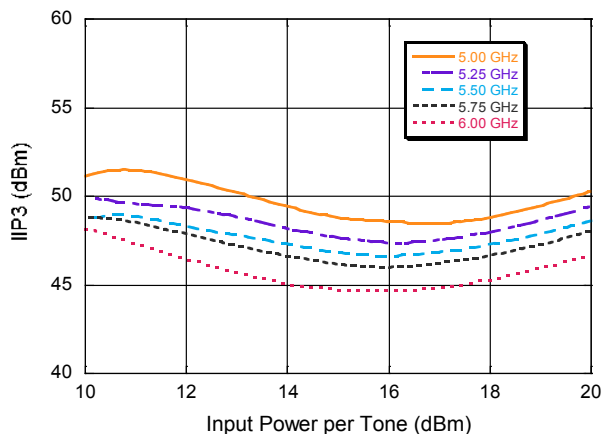

T_x Input IP3 @ -40°C

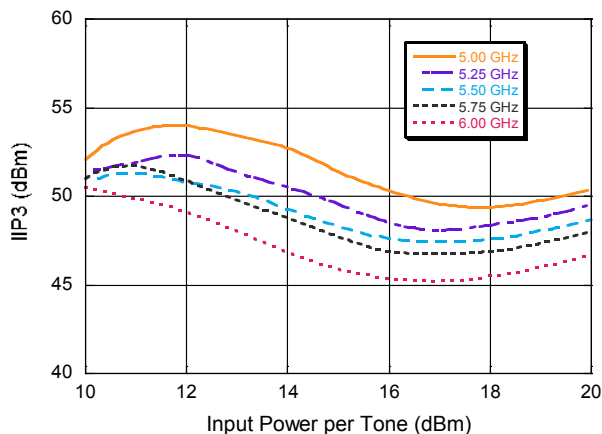

T_x Input IP3 @ +85°C

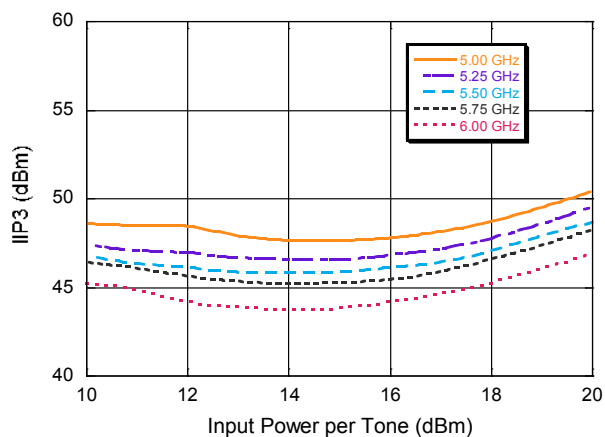

T_x Output IP3 @ +25°C

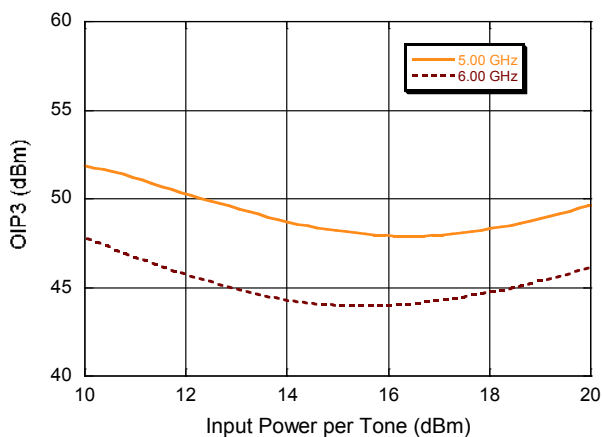

Recommended Sample Board⁹

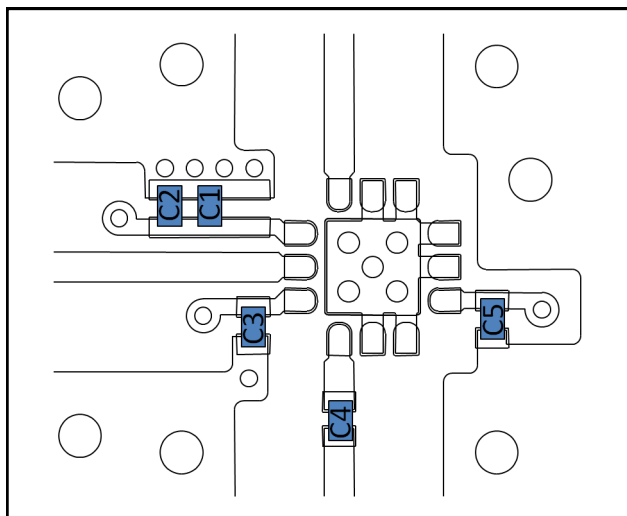

9. Place C1 and C2 as shown.

Functional Schematic

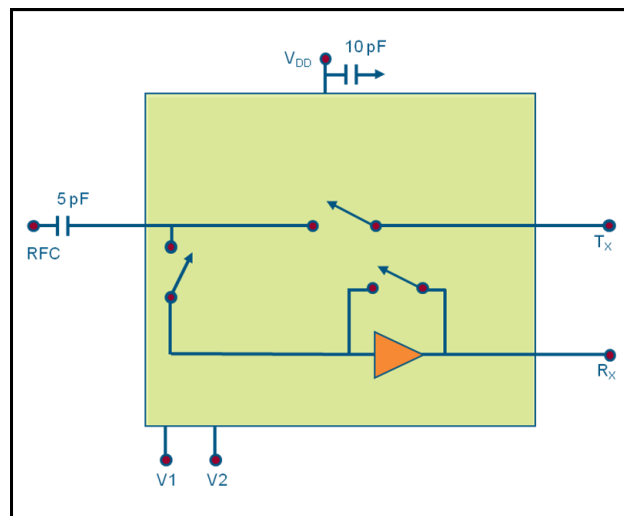

Parts List

Component	Value	Case Size
C1	10 pF	0201
C2, C3, C5	0.1 μ F	0201
C4	5 pF	0201

Handling Procedures

Please observe the following precautions to avoid damage:

Static Sensitivity

Gallium Arsenide Integrated Circuits are sensitive to electrostatic discharge (ESD) and can be damaged by static electricity. Proper ESD control techniques should be used when handling these devices.

System Compensated EVM, 802.11AC 80 MHz / 256 QAM

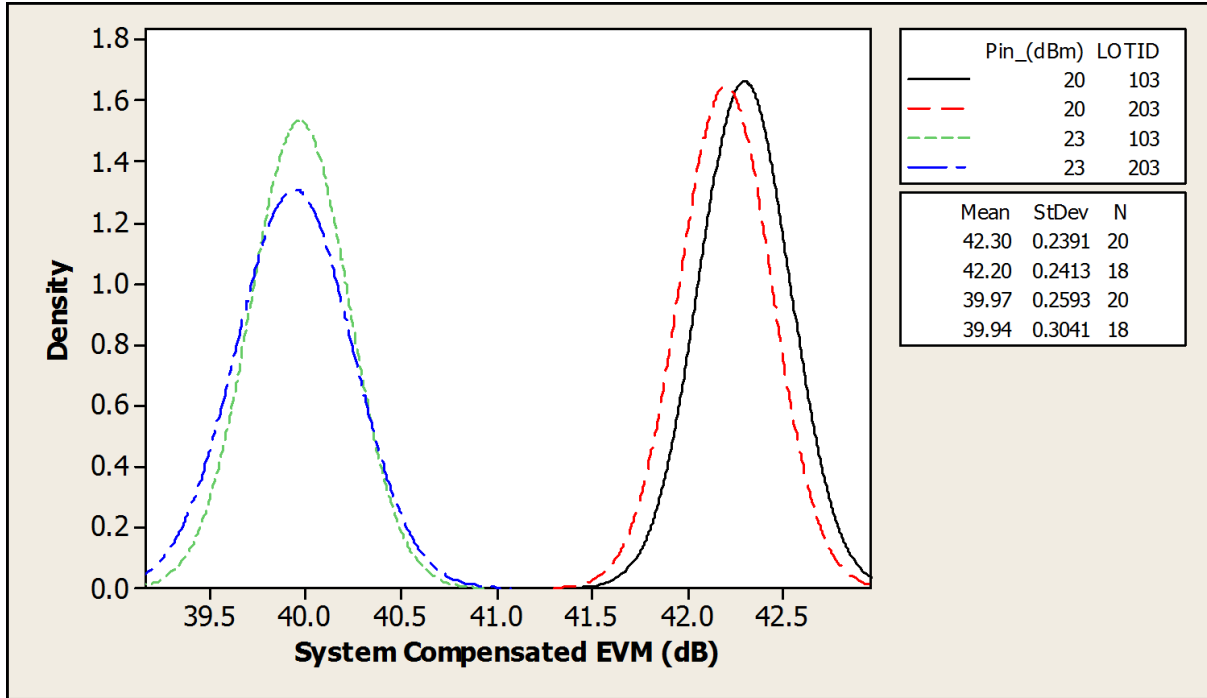

Lead-Free 2 mm STQFN-12LD-0.4mm Pitch†

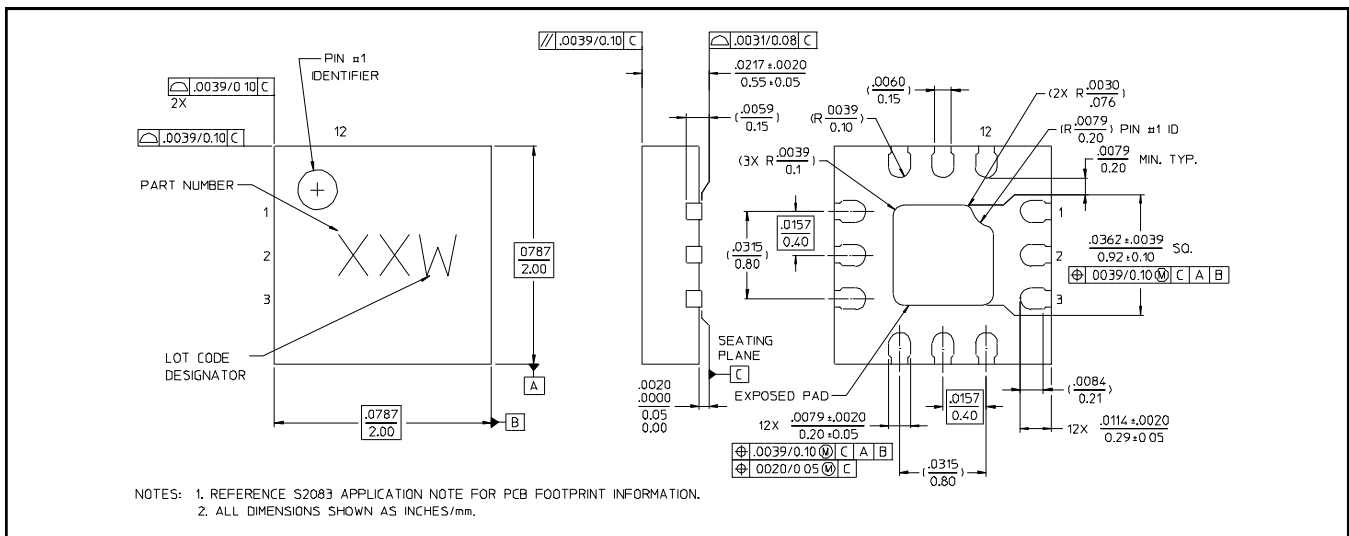

† Reference Application Note S2083 for lead-free solder reflow recommendations.
 Meets JEDEC moisture sensitivity level 1 requirements.
 Plating is Ni/Pd/Au over Copper.

M/A-COM Technology Solutions Inc. All rights reserved.

Information in this document is provided in connection with M/A-COM Technology Solutions Inc ("MACOM") products. These materials are provided by MACOM as a service to its customers and may be used for informational purposes only. Except as provided in MACOM's Terms and Conditions of Sale for such products or in any separate agreement related to this document, MACOM assumes no liability whatsoever. MACOM assumes no responsibility for errors or omissions in these materials. MACOM may make changes to specifications and product descriptions at any time, without notice. MACOM makes no commitment to update the information and shall have no responsibility whatsoever for conflicts or incompatibilities arising from future changes to its specifications and product descriptions. No license, express or implied, by estoppel or otherwise, to any intellectual property rights is granted by this document.

THESE MATERIALS ARE PROVIDED "AS IS" WITHOUT WARRANTY OF ANY KIND, EITHER EXPRESS OR IMPLIED, RELATING TO SALE AND/OR USE OF MACOM PRODUCTS INCLUDING LIABILITY OR WARRANTIES RELATING TO FITNESS FOR A PARTICULAR PURPOSE, CONSEQUENTIAL OR INCIDENTAL DAMAGES, MERCHANTABILITY, OR INFRINGEMENT OF ANY PATENT, COPYRIGHT OR OTHER INTELLECTUAL PROPERTY RIGHT. MACOM FURTHER DOES NOT WARRANT THE ACCURACY OR COMPLETENESS OF THE INFORMATION, TEXT, GRAPHICS OR OTHER ITEMS CONTAINED WITHIN THESE MATERIALS. MACOM SHALL NOT BE LIABLE FOR ANY SPECIAL, INDIRECT, INCIDENTAL, OR CONSEQUENTIAL DAMAGES, INCLUDING WITHOUT LIMITATION, LOST REVENUES OR LOST PROFITS, WHICH MAY RESULT FROM THE USE OF THESE MATERIALS.

MACOM products are not intended for use in medical, lifesaving or life sustaining applications. MACOM customers using or selling MACOM products for use in such applications do so at their own risk and agree to fully indemnify MACOM for any damages resulting from such improper use or sale.