

SESD Series Enhanced ESD Diode Arrays

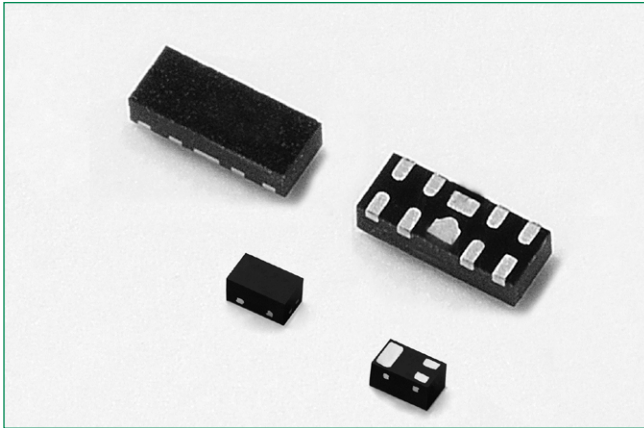

Description

The SESD Series Enhanced ESD Diode Arrays provides higher order ESD protection in signal-integrity-preserving unidirectional arrays for the world's most challenging high speed serial interfaces. Compelling packaging options include the standard 2.5mmx1.0mm and the SOD-883. Standard packages minimize trace layout complexity, save significant PCB space, and improve reusability of the footprints. The nominal capacitance makes the devices applicable to the worlds' fastest consumer serial interfaces.

Pinout

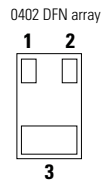
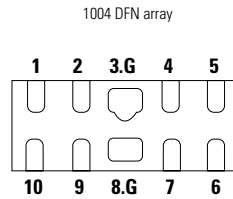

Bottom View

Features

- 0.30pF TYP capacitance
- ESD, IEC61000-4-2, ±22kV contact, ±22kV air
- Low clamping voltage of 13V @ $I_{pp}=2.2A$ ($t_p=8/20\mu s$)
- Low profile 1004 and 0402 DFN array packages
- Facilitates the preservation of signal integrity
- ELV Compliant
- RoHS Compliant and Lead Free
- Moisture Sensitivity Level (MSL Level-1)
- AEC-Q101 qualified
- PPAP capable

Functional Block Diagram

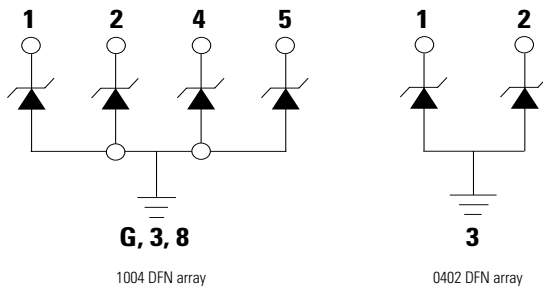

Applications

- Ultra-high speed data lines
- USB 3.1, 3.0, 2.0
- HDMI 2.0, 1.4a, 1.3
- DisplayPort™
- V-by-One®
- Thunderbolt
- Consumer, mobile and portable electronics
- Tablet PC and external storage with high speed interfaces
- Applications requiring high ESD performance in small packages

Additional Information



Datasheet



Resources



Samples

Absolute Maximum Ratings

Symbol	Parameter	Value	Units
I_{PP}	Peak Current ($t_p=8/20\mu s$)	2.2	A
T_{OP}	Operating Temperature	-55 to 125	°C
T_{STOR}	Storage Temperature	-55 to 150	°C

CAUTION: Stresses above those listed in "Absolute Maximum Ratings" may cause permanent damage to the device. This is a stress only rating and operation of the device at these or any other conditions above those indicated in the operational sections of this specification is not implied.

1004 DFN Array Electrical Characteristics - ($T_{Op}=25^\circ C$)

Parameter	Symbol	Test Conditions	Min	Typ	Max	Units
Input Capacitance	$C_{I/O-GND}$	Reverse Bias=0V, f=3GHz		0.30		pF
Breakdown Voltage	V_{BR}	$I_R=1mA$		8.80		V
Reverse Working Voltage	V_{RWM}				7.0	V
Reverse Leakage Current	I_{LEAK}	$V_R=5V$, Any I/O to GND		25		nA
Clamping Voltage	V_C	$I_{pp}=2.2A$, $t_p=8/20\mu s$, Fwd		13.0		V
ESD Withstand Voltage	V_{ESD}	IEC 61000-4-2 (Contact)	± 22			kV
		IEC 61000-4-2 (Air)	± 22			

0402 DFN Array Electrical Characteristics - ($T_{Op}=25^\circ C$)

Parameter	Symbol	Test Conditions	Min	Typ	Max	Units
Input Capacitance	$C_{I/O-GND}$	Reverse Bias=0V, f=3 GHz		0.30		pF
Breakdown Voltage	V_{BR}	$I_R=1mA$		8.80		V
Reverse Working Voltage	V_{RWM}				7.0	V
Reverse Leakage Current	I_{LEAK}	$V_R=5V$, Any I/O to GND		25		nA
Clamping Voltage	V_C	$I_{pp}=2.2A$, $t_p=8/20\mu s$, Fwd		13.0		V
ESD Withstand Voltage	V_{ESD}	IEC61000-4-2 (Contact)	± 22			kV
		IEC61000-4-2 (Air)	± 22			

Insertion Loss Diagram - SESD 1004Q4UG-030-088

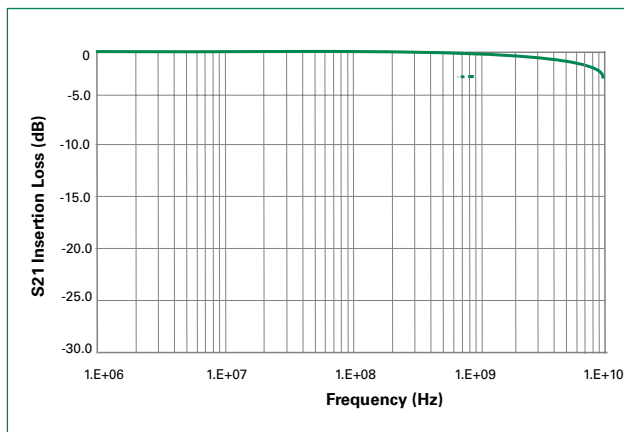

Insertion Loss Diagram - SESD0402Q2UG-0030-088

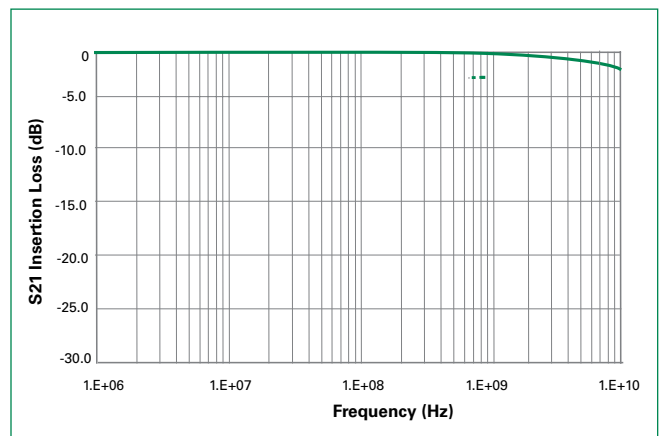

Device IV Curve

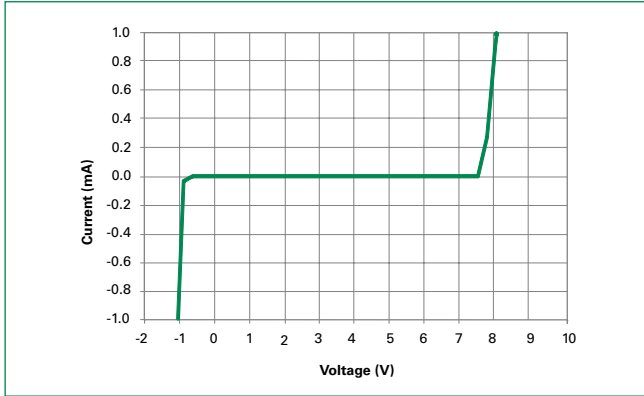

USB3.0 Eye Diagram

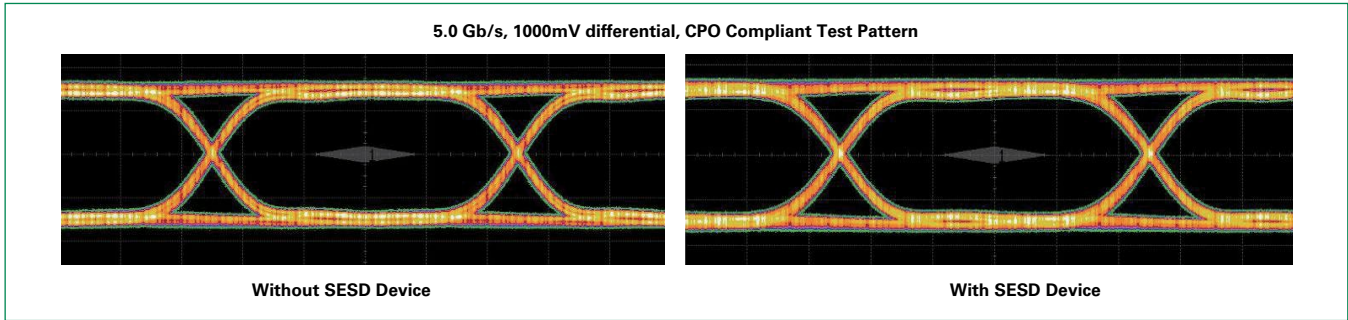

Soldering Parameters

Reflow Condition		Pb – Free assembly
Pre Heat	- Temperature Min ($T_{s(min)}$)	150°C
	- Temperature Max ($T_{s(max)}$)	200°C
	- Time (min to max) (t_s)	60 – 180 secs
Average ramp up rate (Liquidus) Temp (T_L) to peak		3°C/second max
$T_{S(max)}$ to T_L - Ramp-up Rate		3°C/second max
Reflow	- Temperature (T_L) (Liquidus)	217°C
	- Temperature (t_L)	60 – 150 seconds
Peak Temperature (T_p)		260 ^{+0/-5} °C
Time within 5°C of actual peak Temperature (t_p)		20 – 40 seconds
Ramp-down Rate		6°C/second max
Time 25°C to peak Temperature (T_p)		8 minutes Max.
Do not exceed		260°C

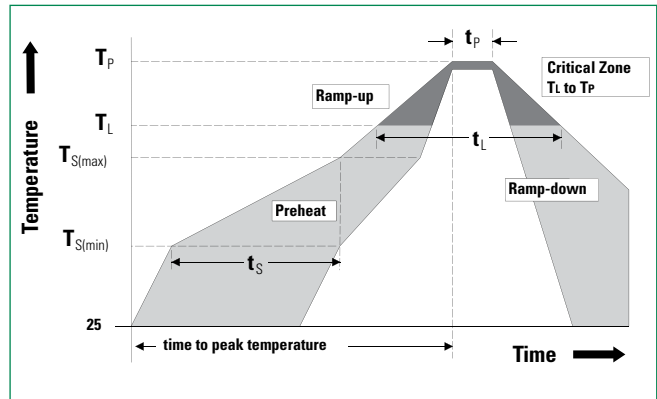

Product Characteristics of 0402 DFN Package

Lead Plating	Pre-Plated Frame
Lead Material	Copper Alloy
Substrate material	Silicon
Body Material	UL Recognized compound meeting flammability rating V-0.

Package Dimensions — 1004 DFN Array

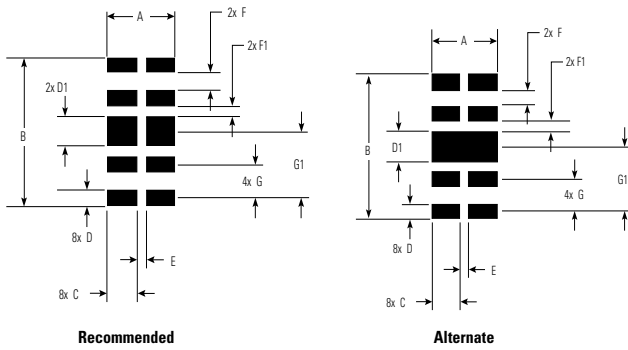
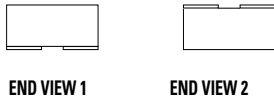
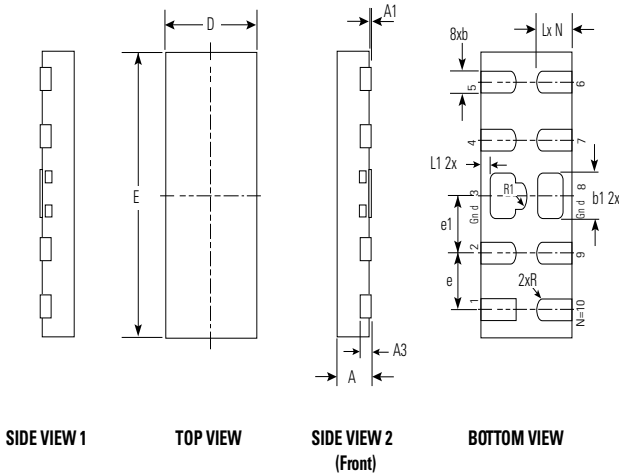

Pad Layout

Symbol	Millimeters			Inches		
	Min	Typ	Max	Min	Typ	Max
A	0.33	0.38	0.43	0.013	0.015	0.017
A1	0.00	0.02	0.05	0	—	0.002
A3	0.127 ref.			0.005 ref.		
D	0.90	1.00	1.10	0.035	0.039	0.043
E	2.40	2.50	2.60	0.094	0.098	0.102
b	0.15	0.20	0.25	0.006	0.008	0.010
b1	0.35	0.40	0.45	0.014	0.016	0.018
L	0.33	0.38	0.43	0.013	0.015	0.017
L1	0.00	0.10	0.15	0.000	0.004	0.006
e	0.50 BSC			0.020 BSC		
e1	0.50 BSC			0.020 BSC		
R	0.08 BSC			0.003 BSC		
R1	0.13 BSC			0.005 BSC		
N	10			10		

Symbol	Millimeters	Inches
A	1.20	0.047
B	2.20	0.087
C	0.50	0.020
D	0.20	0.008
D1	0.40	0.016
E	0.20	0.008
F	0.30	0.012
F1	0.20	0.008
G	0.50 BSC	0.020 BSC
G1	1.00 BSC	0.039 BSC

Package Dimensions — 0402 DFN Array

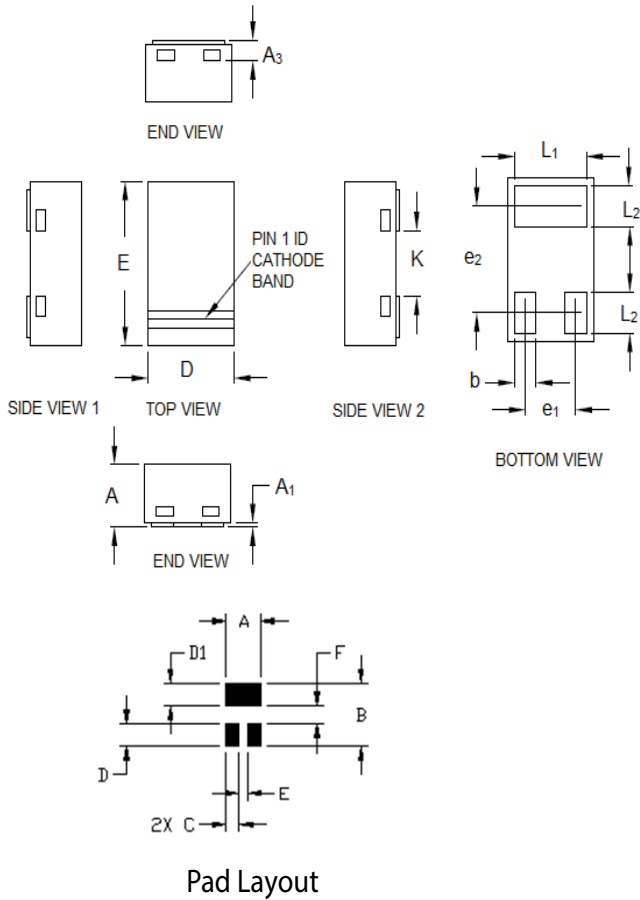

Symbol	Millimeters			Inches		
	Min	Typ	Max	Min	Typ	Max
A	0.33	0.38	0.43	0.013	0.015	0.017
A1	0	-	0.05	0	-	0.002
A3	0.13 ref.			0.005 ref.		
D	0.55	0.60	0.65	0.022	0.024	0.026
E	0.95	1.00	1.05	0.037	0.039	0.041
K	0.35	0.40	0.45	0.014	0.016	0.018
L1	0.45	0.50	0.55	0.018	0.020	0.022
L2	0.20	0.25	0.30	0.008	0.010	0.012
b	0.14	0.19	0.24	0.006	0.007	0.009
e1	0.35 BSC			0.014 BSC		
e2	0.65 BSC			0.026 BSC		

Symbol	Millimeters	Inches
A	0.60	0.024
B	1.00	0.039
C	0.23	0.009
D	0.35	0.014
D1	0.35	0.014
E	0.15	0.006
F	0.30	0.012

Part Numbering System

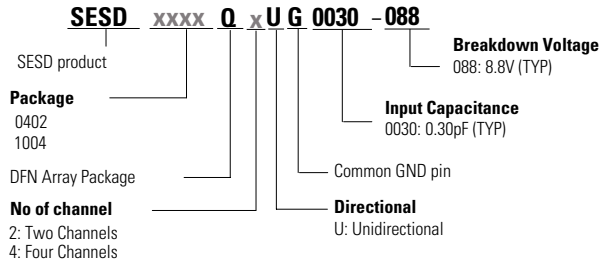

Part Marking System

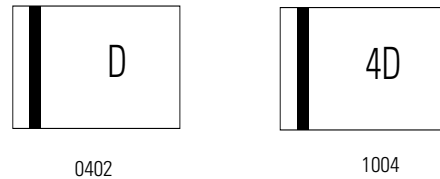

Ordering Information

Part Number	Package	Ordering Part Number	Minimum Order Quantity
SESD0402Q2UG-0030-088	0402 DFN Array	RF3925-000	50,000
SESD1004Q4UG-0030-088	1004 DFN Array	RF3923-000	25,000

Embossed Carrier Tape & Reel Specification – 1004 DFN Array

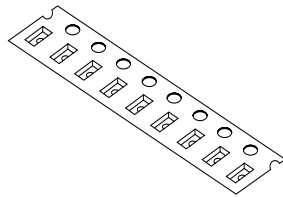
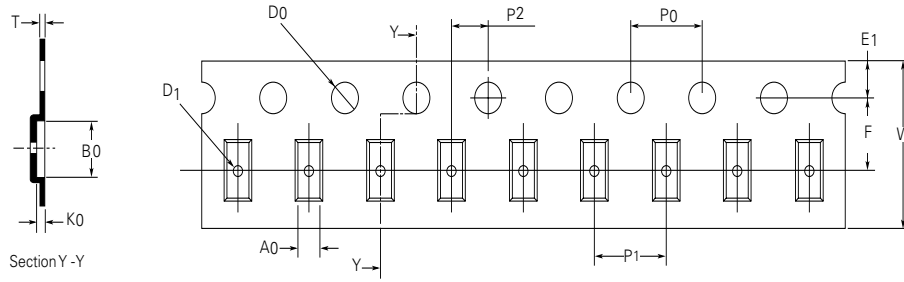

Symbol	Millimeters
A0	1.20 ± 0.05
B0	2.70 ± 0.05
D0	∅ 1.50 + 0.10/-0
D1	∅ 0.50 min
E1	1.75 ± 0.10
F	3.50 ± 0.05
K0	0.51 ± 0.05
P0	4.00 ± 0.10
P1	4.00 ± 0.10
P2	2.00 ± 0.05
W	8.00 +0.03 / -0.10
T	0.25 ± 0.05

Embossed Carrier Tape & Reel Specification – 0402 DFN Array

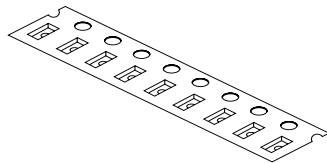
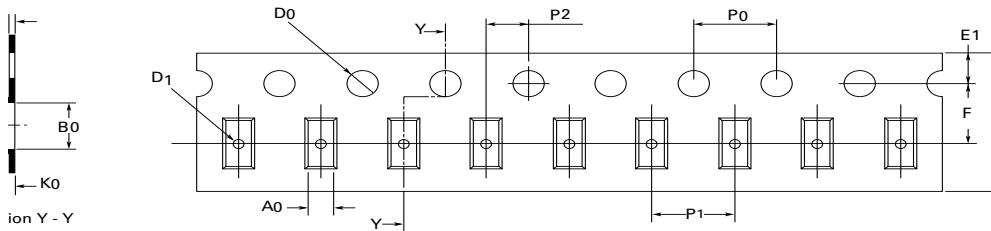

Symbol	Millimeters
A0	0.70+/-0.05
B0	1.15+/-0.05
D0	∅ 1.55+ 0.05
D1	∅ 0.40+/- 0.05
E1	1.75+/-0.10
F	3.50+/-0.05
K0	0.47+/-0.05
P0	4.00+/-0.10
P1	2.00+/-0.10
P2	2.00+/-0.05
W	8.00+/-0.10
T	0.20+/-0.05

Disclaimer Notice - Information furnished is believed to be accurate and reliable. However, users should independently evaluate the suitability of and test each product selected for their own applications. Littelfuse products are not designed for, and may not be used in, all applications. Read complete Disclaimer Notice at <http://www.littelfuse.com/disclaimer-electronics>.