



SPECIFICATION SHEET

SPECIFICATION SHEET NO.	N0828-SMF11CA00S11CA
DATE	Aug. 28, 2021
REVISION	A0
DESCRIPTION	<p>SMD Transient Voltage Suppressor (TVS) Diodes, SMF/SOD-123FL series, SMF11CA Type, 2 Pads, Bidirectional Type</p> <p>Stand-off Voltage 11V Max. Power Dissipation: 200 Watts Min.</p> <p>Operating Temp. Range -55°C ~+150°C</p> <p>Package in Tape/Reel, 3000pcs/Reel</p> <p>RoHS/RoHS III compliant</p>
CUSTOMER	
CUSTOMER PART NUMBER	
CROSS REF. PART NUMBER	
ORIGINAL PART NUMBER	MDD SMF11CA
PART CODE	SMF11CA00S11CA

VENDOR APPROVE			
Issued/Checked/Approved			
DATE: Aug. 28, 2021			

CUSTOMER APPROVE	
DATE:	

SMD TRANSIENT VOLTAGE SUPPRESSORS DIODES SMF SERIES

MAIN FEATURE

- Low profile package
- Glass passivated chip junction
- Low inductance
- Plastic package has Underwriters Laboratory Flammability



APPLICATION

- For SMD application

RFQ

[Request For Quotation](#)

PART CODE GUIDE

SMF	11CA00	S	11CA
1	2	3	4

- 1) **SMF**: SMD Transient Voltage Suppressor (TVs) Diodes, SMF/SOD-123FL series
- 2) **11CA00**: Type code for original part number SMF11CA
- 3) **S**: Package code, Tape/reel, 3000pcs/reel.
- 4) **11CA**: Marking code for “11CA” on the case surface, Different Marking for different specification.

SMD TRANSIENT VOLTAGE SUPPRESSORS DIODES SMF SERIES

MORE ITEMS AVAILABLE- Unidirectional Type

SMF050A00S050A	SMF060A00S060A	SMF065A00S065A	SMF070A00S070A	SMF075A00S075A
SMF080A00S080A	SMF085A00S085A	SMF090A00S090A	SMF10A0000S10A	SMF11A0000S11A
SMF12A0000S12A	SMF13A0000S13A	SMF14A0000S14A	SMF15A0000S15A	SMF16A0000S16A
SMF17A0000S17A	SMF18A0000S18A	SMF20A0000S20A	SMF22A0000S22A	SMF24A0000S24A
SMF26A0000S26A	SMF28A0000S28A	SMF30A0000S30A	SMF33A0000S33A	SMF36A0000S36A
SMF40A0000S40A	SMF43A0000S43A	SMF45A0000S45A	SMF48A0000S48A	SMF51A0000S51A
SMF54A0000S54A	SMF58A0000S58A	SMF60A0000S60A	SMF64A0000S64A	SMF70A0000S70A
SMF75A0000S75A	SMF78A0000S78A	SMF85A0000S85A	SMF90A0000S90A	SMF100A00S100A
SMF110A00S110A	SMF120A00S120A	SMF130A00S130A	SMF150A00S150A	SMF160A00S160A
SMF170A00S170A	SMF180A00S180A	SMF200A00S200A	SMF220A00S220A	SMF250A00S250A
SMF300A00S300A	SMF350A00S350A	SMF400A00S400A	SMF440A00S440A	

MORE ITEMS AVAILABLE- Bidirectional Type

SMF050CAS050CA	SMF060CAS060CA	SMF065CAS065CA	SMF070CAS070CA	SMF075CAS075CA
SMF080CA0S080CA	SMF085CAS085CA	SMF090CAS090CA	SMF10CA00S10CA	SMF11CA00S11CA
SMF12CA00S12CA	SMF13CA00S13CA	SMF14CA00S14CA	SMF15CA00S15CA	SMF16CA00S16CA
SMF17CA00S17CA	SMF18CA00S18CA	SMF20CA00S20CA	SMF22CA00S22CA	SMF24CA00S24CA
SMF26CA00S26CA	SMF28CA00S28CA	SMF30CA00S30CA	SMF33CA00S33CA	SMF36CA00S36CA
SMF40CA00S40CA	SMF43CA00S43CA	SMF45CA00S45CA	SMF48CA00S48CA	SMF51CA00S51CA
SMF54CA00S54CA	SMF58CA00S58CA	SMF60CA00S60CA	SMF64CA00S64CA	SMF70CA00S70CA
SMF75CA00S75CA	SMF78CA00S78CA	SMF85CA00S85CA	SMF90CA00S90CA	SMF100CAS100CA
SMF110CAS110CA	SMF120CAS120CA	SMF130CAS130CA	SMF150CAS150CA	SMF160CAS160CA
SMF170CAS170CA	SMF180CAS180CA	SMF200CAS200CA	SMF220CAS220CA	SMF250CAS250CA
SMF300CAS300CA	SMF350CAS350CA	SMF400CAS400CA	SMF440CAS440CA	

SMD TRANSIENT VOLTAGE SUPPRESSORS DIODES SMF SERIES

DIMENSION (Unit: Inch/mm)

Image for reference



Marking: 11CA

SMF/SOD-123FL

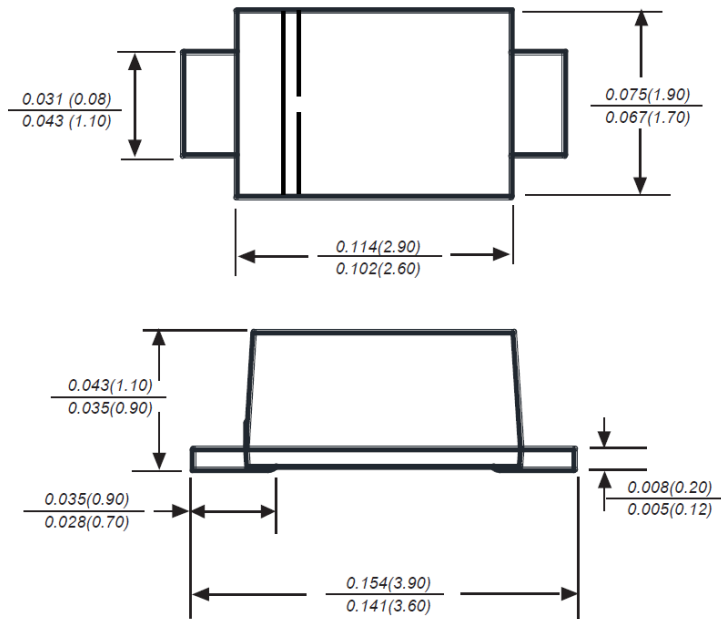

Recommend Pad Layout

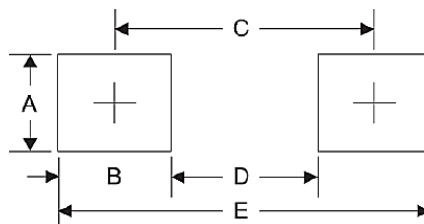

Symbol	Unit (Inch)	Unit (mm)
A	0.047	1.20
B	0.047	1.20
C	0.126	3.20
D	0.079	2.00
E	0.173	4.40

SMD TRANSIENT VOLTAGE SUPPRESSORS DIODES SMF SERIES
MECHANICAL DATA

Case	Terminals	Polarity	Mounting Position	Weight per piece
JEDEC SMF/SOD-123FL molded plastic body	Solder plated, Solderable per MIL-STD-750, Method 2026	Polarity symbol marking on case	Any	0.0007 Ounce, 0.0198 grams

MAX. RATING & CHARACTERISTICS - Ratings at 25°C ambient temperature unless otherwise specified.

Parameter	SYMBOLS	VALUE			UNITS
		Min.	Typical	Max.	
Peak pulse power dissipation (Note 1,2,5, Fig.1)	P _{ppm}	200			W
Peak Forward surge current (Note 3)	I _{FSM}		30		A
Peak pulse current on 10/1000µs waveform (Note 1, Fig.2)	I _{ppm}			11.0	A
Steady state power dissipation (Note 4)	P _{M(AV)}		1.0		W
Operating junction temperature range	T _J	-55		+150	°C
Storage temperature range	T _{STG}	-55		+150	°C
Thermal resistance junction to ambient	R _{θJA}		180		°C/W

Note

1. Non-repetitive current pulse, per Fig 3 and derated above TA=25 °C per Fig 2
2. Mounted on 5.0*5.0mm copper pads to each terminal
3. 8.3ms single half sinewave or equivalent square wave, duty cycle=4 pulsed per minute Max.
4. Lead temperature at T_L=75 °C
5. Peak pulse power waveform is tp =10/1000µs
6. A transient suppressor is selected according to the working peak reverse voltage (V_{RWM}), which should be equal to or great than the DC or continuous peak operating voltage level.

ELECTRICAL CHARACTERISTICS - Ratings at 25°C

Parameter	SYMBOLS	VALUE	UNITS
Reverse Stand-Off	V _{RWM}	11	V
Breakdown Voltage @I _T	V _{BR}	12.20~13.50	V
Test Current	I _T	1	mA
Reverse Leakage @V _{RWM}	I _R	2.5	µA
VoltageMaximum Clamping Voltage @I _{PP}	V _C	18.20	V
Peak Pulse Current	I _{PP}	11.0	A

SMD TRANSIENT VOLTAGE SUPPRESSORS DIODES SMF SERIES

RELIABILITY

Number	Experiment Items	Experiment Method And Conditions	Reference Documents
1	Solder Resistance Test	Test 260°C± 5°C for 10 ± 2 sec. Immerse body into solder 1/16" ± 1/32"	MIL-STD-750D METHOD-2031.2
2	Solderability Test	230°C ±5°C for 5 sec.	MIL-STD-750D METHOD-2026.1 0
3	Pull Test	1 kg in axial lead direction for 10 sec.	MIL-STD-750D METHOD-2036.4
4	Bend Test	0.5Kg Weight Applied To Each Lead, Bending Arcs 90 °C ± 5 °C For 3 Times	MIL-STD-750D METHOD-2036.4
5	High Temperature Reverse Bias Test	TA=100°C for 1000 Hours at VR=80% Rated VR	MIL-STD-750D METHOD-1038.4
6	Forward Operation Life Test	TA=25°C Rated Average Rectified Current	MIL-STD-750D METHOD-1027.3
7	Intermittent Operation Life Test	On state: 5 min with rated IRMS Power Off state: 5 min with Cool Forced Air. On and off for 1000 cycles.	MIL-STD-750D METHOD-1036.3
8	Pressure Cooker Test	15 PSIG, TA=121°C, 4 hours	MIL-S-19500 APPENOIXC
9	Temperature Cycling Test	-55°C~+125°C; 30 Minutes For Dwelled Time 5 minutes for transferred time. Total: 10 cycles.	MIL-STD-750D METHOD-1051.7
10	Thermal Shock Test	0°C for 5 minutes., 100°C for 5minutes, Total: 10 cycles	MIL-STD-750D METHOD-1056.7
11	Forward Surge Test	8.3ms Single Sale Sine-wave One Surge.	MIL-STD-750D METHOD-4066.4
12	Humidity Test	TA=65°C, RH=98% for 1000 hours.	MIL-STD-750D METHOD-1021.3
13	High Temperature Storage life Test	150°C for 1000 Hours	MIL-STD-750D METHOD-1031.5

SMD TRANSIENT VOLTAGE SUPPRESSORS DIODES SMF SERIES

SUGGESTED REFLOW PROFILE (For Reference Only)

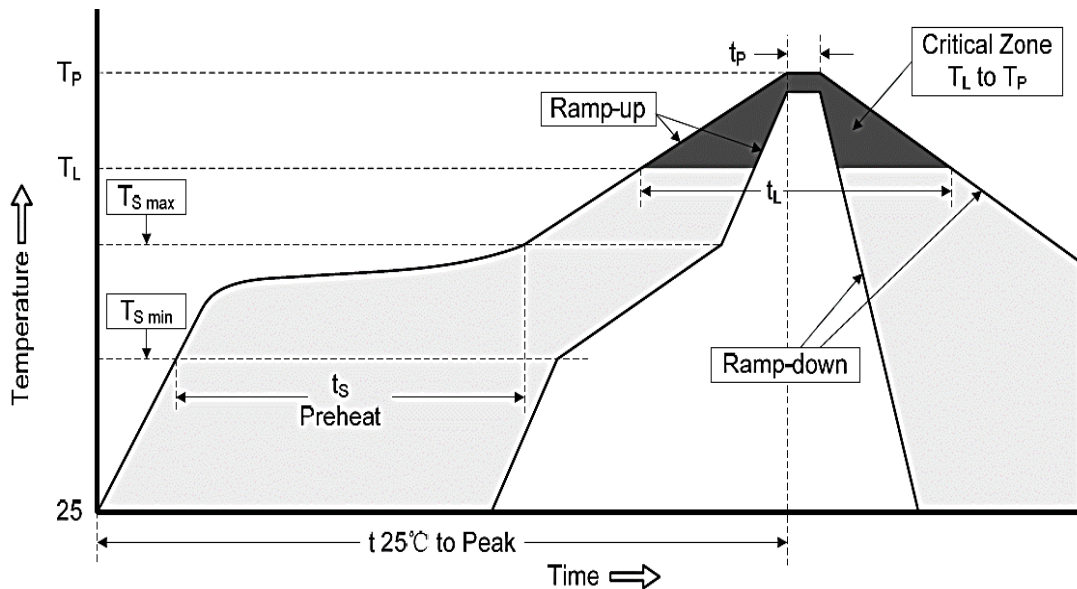

Profile Feature		Pb-Free Assembly
Average Ramp-up Rate (Ts Max to Tp)		3°C/second Max
Preheat	Temperature Min (Ts Min.)	150°C
	Temperature Max (Ts Max.)	200°C
	Time (ts Min. to ts Max.)	60 ~ 180 seconds
Time maintained above	Temperature (Tl)	217°C
	Time (tL)	60 ~ 150 seconds
Peak/Classification Temperature (Tp)		260 °C
Time within 5°C of actual Peak Temperature (tp)		20 ~ 40 seconds
Ramp-down rate		6 °C /Second Max.
Time 25 °C to Peak Temperature		8 minutes Max.
Suggest reflow times		3 Times Max.

SMD TRANSIENT VOLTAGE SUPPRESSORS DIODES SMF SERIES

RATINGS AND CHARACTERISTIC CURVES (For Reference Only)

Fig.1 Peak Pulse Power Rating Curve

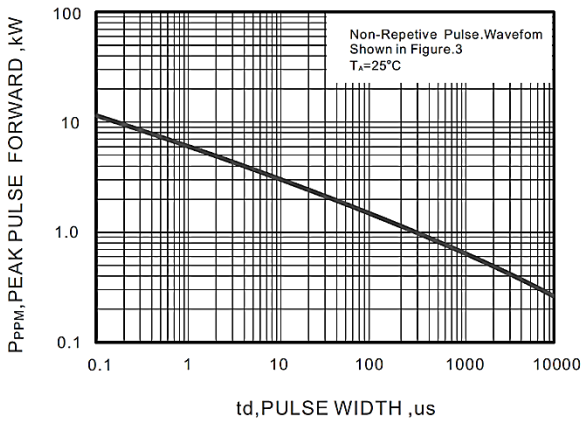

Fig.2 Forward Current Derating Curve

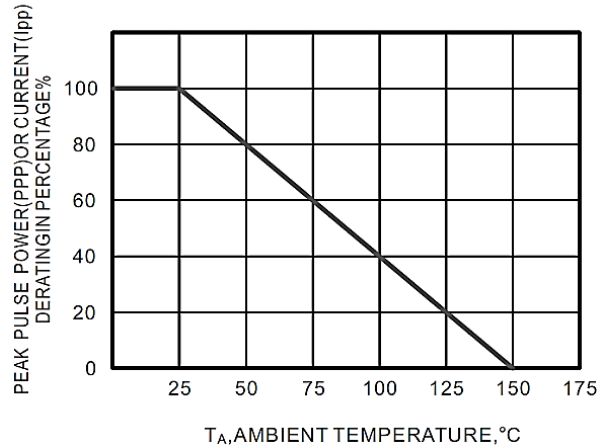

Fig.3 Pulse Waveform

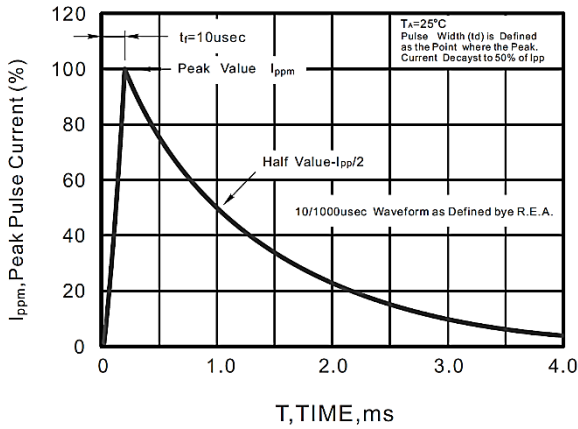
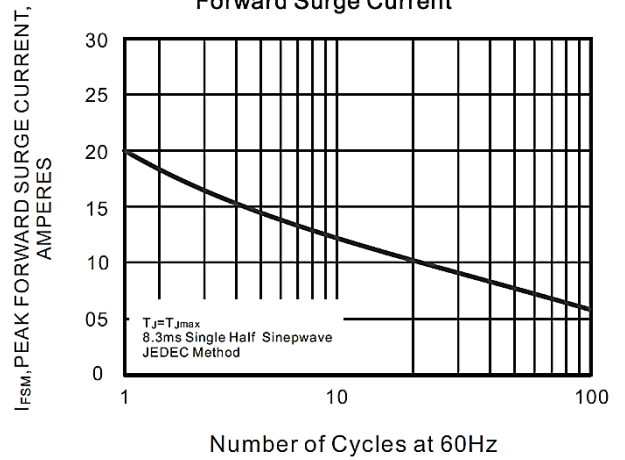

Fig.4 Maximum Non-Repetitive Peak Forward Surge Current



SMD TRANSIENT VOLTAGE SUPPRESSORS DIODES SMF SERIES

TAPE/REEL (Unit: mm)

All Devices are packed in accordance with EIA standard RS-481-A and specifications.



Item	Symbol	Tolerance	SMF/SOD-123FL
Carrier width	A	0.1	2.10
Carrier Length	B	0.1	4.00
Carrier Depth	C	0.1	1.60
Sprocket hole	d	0.05	1.55
7"Reel outside diameter	D	2.0	178.00
7"Reel inner diameter	D1	Min.	50.00
Feed hole diameter	D2	0.5	13.00
Sprocket hole position	E	0.1	1.75
Punch hole position	F	0.1	3.50
Punch hole pitch	P	0.1	4.00
Sprocket hole pitch	P0	0.1	4.00
Embossment center	P1	0.1	2.00
Overall tape thickness	T	0.1	0.25
Tape width	W	0.3	8.15
Reel width	W1	1.0	10.50

SMD TRANSIENT VOLTAGE SUPPRESSORS DIODES SMF SERIES

PACKAGE for reference

Case Code	Reel Size	MPQ (pcs)	Component Spacing (mm)	Qty. Per Box (pcs)	Inner Box L*W*H (mm)	Reel Size (mm)	Carton size L*W*H (mm)	Qty. Per Carton (pcs)	G. W (kg)
SMF/SOD-123FL	7"	3,000		6,000	190*190*50	178	400*400*250	180,000	9.0

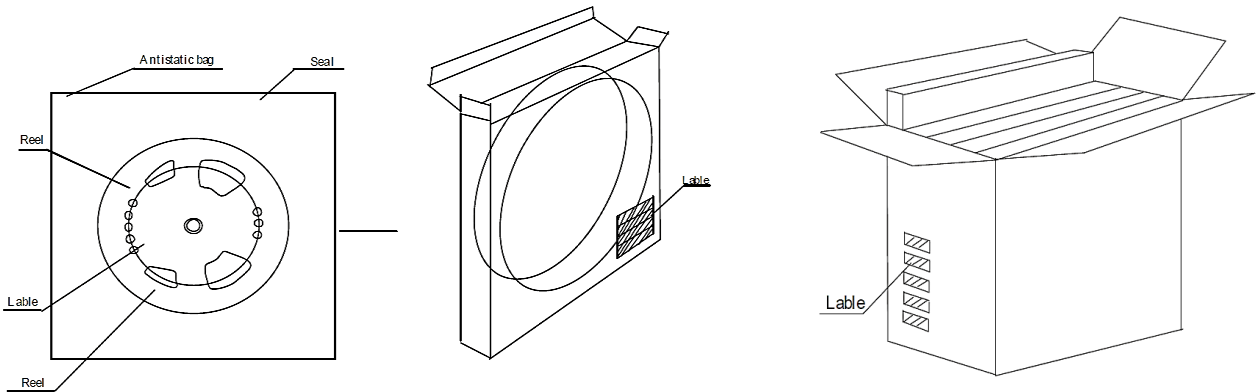

DISCLAIMER

NextGen Component, Inc. reserves the right to make changes to the product(s) and or information contained herein without notice. No liability is assumed as a result of their use or application. No rights under any patent accompany the sale of any such product(s) or information