

## Features

- Low On-Resistance
- Low Gate Threshold Voltage
- Low Input Capacitance
- Fast Switching Speed
- Low Input/Output Leakage
- **ESD Protected Gate**
- **Totally Lead-Free & Fully RoHS Compliant (Notes 1 & 2)**
- **Halogen and Antimony Free. "Green" Device (Note 3)**
- **Qualified to AEC-Q101 Standards for High Reliability**

## Mechanical Data

- Case: SOT523
- Case Material: Molded Plastic, "Green" Molding Compound.  
UL Flammability Classification Rating 94V-0
- Moisture Sensitivity: Level 1 per J-STD-020
- Terminals: Finish — Matte Tin Annealed over Alloy 42 leadframe. Solderable per MIL-STD-202, Method 208 Ⓔ<sup>3</sup>
- Terminal Connections: See Diagram
- Weight: 0.002 grams (Approximate)

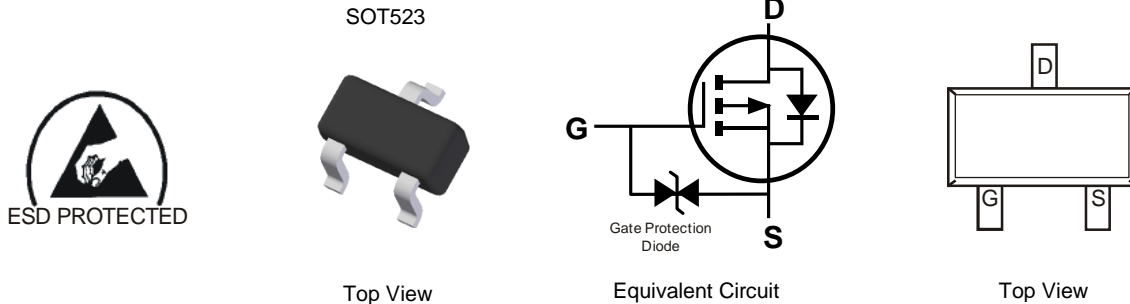

## Ordering Information (Note 4)

Part Number	Case	Packaging
DMP2004TK-7	SOT523	3,000/Tape & Reel

- Notes:
1. No purposely added lead. Fully EU Directive 2002/95/EC (RoHS), 2011/65/EU (RoHS 2) & 2015/863/EU (RoHS 3) compliant.
  2. See <https://www.diodes.com/quality/lead-free/> for more information about Diodes Incorporated's definitions of Halogen- and Antimony-free, "Green" and Lead-free.
  3. Halogen- and Antimony-free "Green" products are defined as those which contain <900ppm bromine, <900ppm chlorine (<1500ppm total Br + Cl) and <1000ppm antimony compounds.
  4. For packaging details, go to our website at <https://www.diodes.com/design/support/packaging/diodes-packaging/>.

## Marking Information

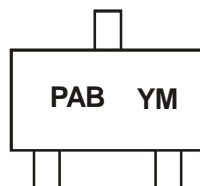

PAB = Product Type Marking Code  
 YM = Date Code Marking  
 Y = Year (ex: F = 2018)  
 M = Month (ex: 9 = September)

### Date Code Key

<b>Year Code</b>	2006 T	2007 U	...	2014 B	2015 C	2016 D	2017 E	2018 F	2019 G	2020 H	2021 I	2022 J
<b>Month Code</b>	Jan 1	Feb 2	Mar 3	Apr 4	May 5	Jun 6	Jul 7	Aug 8	Sep 9	Oct O	Nov N	Dec D

**Maximum Ratings** (@T<sub>A</sub> = +25°C, unless otherwise specified.)

Characteristic			Symbol	Value	Unit
Drain-Source Voltage			V <sub>DSS</sub>	-20	V
Gate-Source Voltage			V <sub>GSS</sub>	±8	V
Drain Current (Note 5)	Steady State	T <sub>A</sub> = +25°C	I <sub>D</sub>	-430	mA
		T <sub>A</sub> = +85°C		-310	
Pulsed Drain Current (Note 6)			I <sub>DM</sub>	-750	mA

**Thermal Characteristics** (@T<sub>A</sub> = +25°C, unless otherwise specified.)

Characteristic		Symbol	Value	Unit
Total Power Dissipation (Note 5)		P <sub>D</sub>	230	mW
Thermal Resistance, Junction to Ambient (Note 5)	Steady State	R <sub>θJA</sub>	558	°C/W
Total Power Dissipation (Note 6)		P <sub>D</sub>	320	mW
Thermal Resistance, Junction to Ambient (Note 6)	Steady State	R <sub>θJA</sub>	393	°C/W
Operating and Storage Temperature Range		T <sub>J</sub> , T <sub>STG</sub>	-55 to +150	°C

**Electrical Characteristics** (@T<sub>A</sub> = +25°C, unless otherwise specified.)

Characteristic	Symbol	Min	Typ	Max	Unit	Test Condition
<b>OFF CHARACTERISTICS (Note 7)</b>						
Drain-Source Breakdown Voltage	BV <sub>DSS</sub>	-20	—	—	V	V <sub>GS</sub> = 0V, I <sub>D</sub> = -250μA
Zero Gate Voltage Drain Current	I <sub>DSS</sub>	—	—	-1.0	μA	V <sub>DS</sub> = -20V, V <sub>GS</sub> = 0V
Gate-Source Leakage	I <sub>GSS</sub>	—	—	±1.0	μA	V <sub>GS</sub> = ±4.5V, V <sub>DS</sub> = 0V
<b>ON CHARACTERISTICS (Note 7)</b>						
Gate Threshold Voltage	V <sub>GS(TH)</sub>	-0.5	—	-1.0	V	V <sub>DS</sub> = V <sub>GS</sub> , I <sub>D</sub> = -250μA
Static Drain-Source On-Resistance	R <sub>DS(ON)</sub>	—	0.7	1.1	Ω	V <sub>GS</sub> = -4.5V, I <sub>D</sub> = -430mA
		—	1.0	1.6		V <sub>GS</sub> = -2.5V, I <sub>D</sub> = -300mA
		—	1.3	2.4		V <sub>GS</sub> = -1.8V, I <sub>D</sub> = -150mA
Diode Forward Voltage	V <sub>SD</sub>	—	-0.8	-1.4	V	V <sub>GS</sub> = 0V, I <sub>S</sub> = -115mA
<b>DYNAMIC CHARACTERISTICS (Note 8)</b>						
Input Capacitance	C <sub>iss</sub>	—	47	—	pF	V <sub>DS</sub> = -16V, V <sub>GS</sub> = 0V f = 1.0MHz
Output Capacitance	C <sub>oss</sub>	—	6.8	—	pF	
Reverse Transfer Capacitance	C <sub>rss</sub>	—	4.9	—	pF	
Gate Resistance	R <sub>g</sub>	—	240	—	Ω	V <sub>DS</sub> = 0V, V <sub>GS</sub> = 0V
Total Gate Charge V <sub>GS</sub> = -4.5V	Q <sub>g</sub>	—	0.55	—	nC	V <sub>DS</sub> = -10V, I <sub>D</sub> = -250mA
Total Gate Charge V <sub>GS</sub> = -8V	Q <sub>g</sub>	—	0.97	—	nC	
Gate-Source Charge	Q <sub>gs</sub>	—	0.05	—	nC	
Gate-Drain Charge	Q <sub>gd</sub>	—	0.1	—	nC	
Turn-On Delay Time	t <sub>D(ON)</sub>	—	5.9	—	ns	V <sub>DD</sub> = -3V, V <sub>GS</sub> = -2.5V, R <sub>G</sub> = 25Ω, I <sub>D</sub> = -100mA
Turn-On Rise Time	t <sub>r</sub>	—	3.3	—	ns	
Turn-Off Delay Time	t <sub>D(OFF)</sub>	—	25.5	—	ns	
Turn-Off Fall Time	t <sub>f</sub>	—	19.3	—	ns	
Reverse Recovery Time	t <sub>RR</sub>	—	7.3	—	ns	I <sub>F</sub> = -1A, di/dt = -100A/μs
Reverse Recovery Charge	Q <sub>RR</sub>	—	1.9	—	nC	I <sub>F</sub> = -1A, di/dt = -100A/μs

- Notes:
5. Device mounted on FR-4 PCB, with minimum recommended pad layout.
  6. Device mounted on 1" x 1" FR-4 PCB with high coverage 2oz. Copper, single sided.
  7. Short duration pulse test used to minimize self-heating effect.
  8. Guaranteed by design. Not subject to product testing.

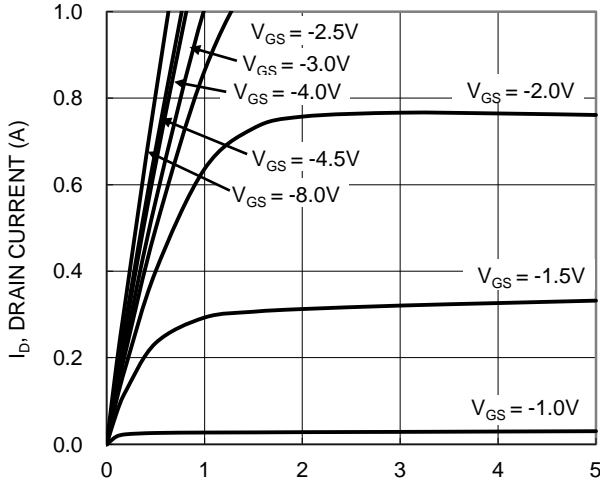

$V_{DS}$ , DRAIN-SOURCE VOLTAGE (V)  
Figure 1. Typical Output Characteristic

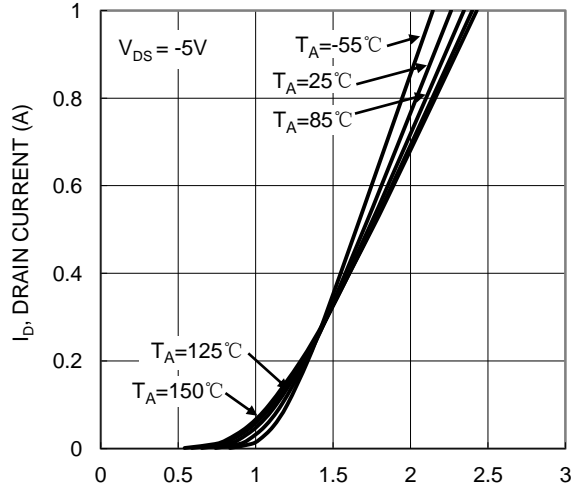

$V_{GS}$ , GATE-SOURCE VOLTAGE (V)  
Figure 2. Typical Transfer Characteristic

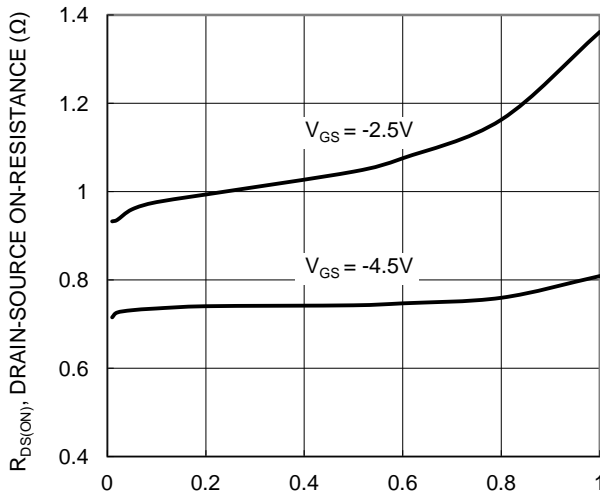

$I_D$ , DRAIN-SOURCE CURRENT (A)  
Figure 3. Typical On-Resistance vs. Drain Current and Gate Voltage

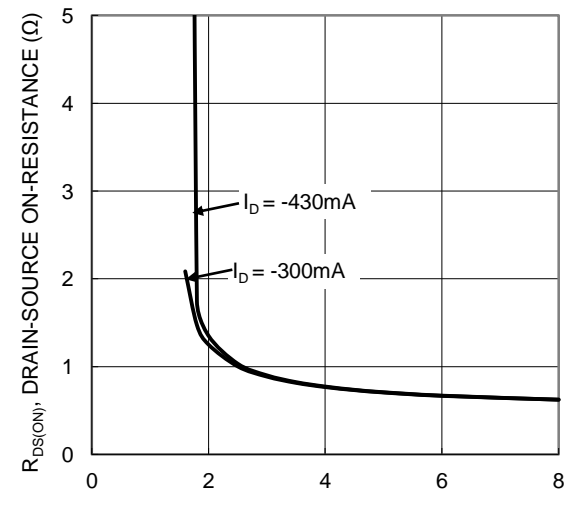

$V_{GS}$ , GATE-SOURCE VOLTAGE (V)  
Figure 4. Typical Transfer Characteristic

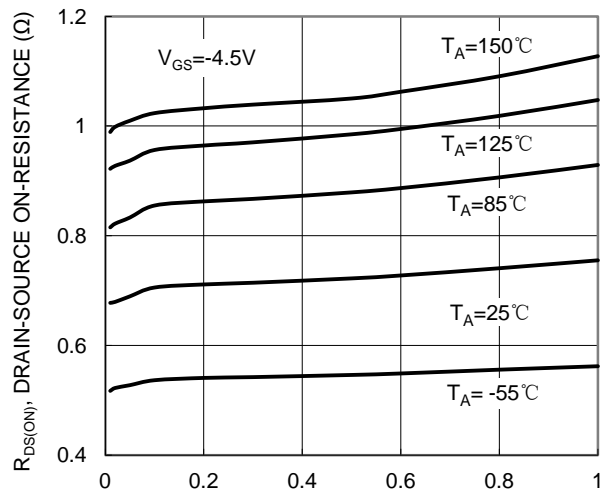

$I_D$ , DRAIN CURRENT (A)  
Figure 5. Typical On-Resistance vs. Drain Current and Temperature

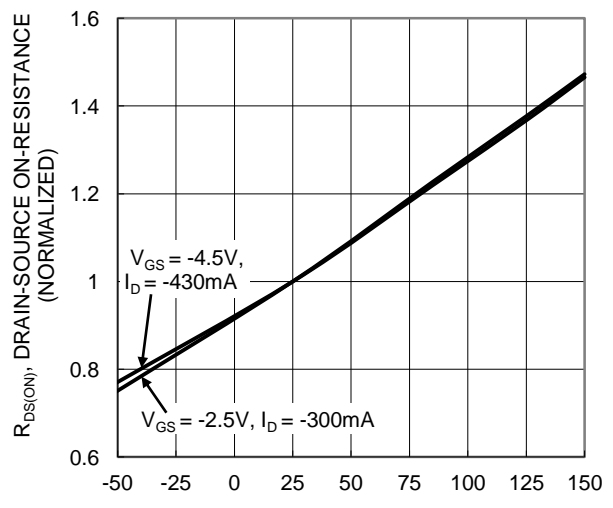

$T_J$ , JUNCTION TEMPERATURE ( $^\circ C$ )  
Figure 6. On-Resistance Variation with Temperature

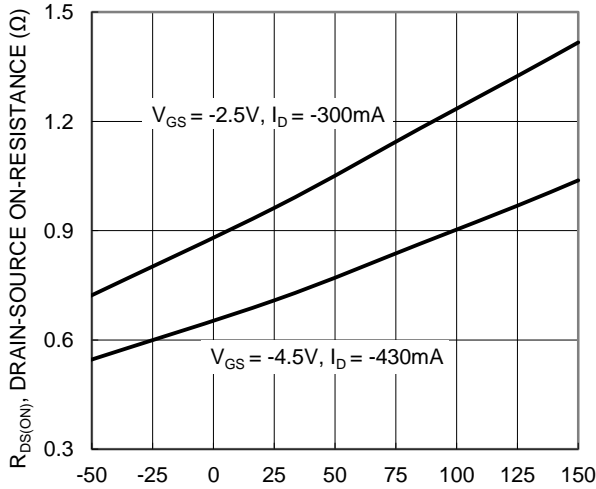

T<sub>J</sub>, JUNCTION TEMPERATURE (°C)  
Figure 7. On-Resistance Variation with Temperature

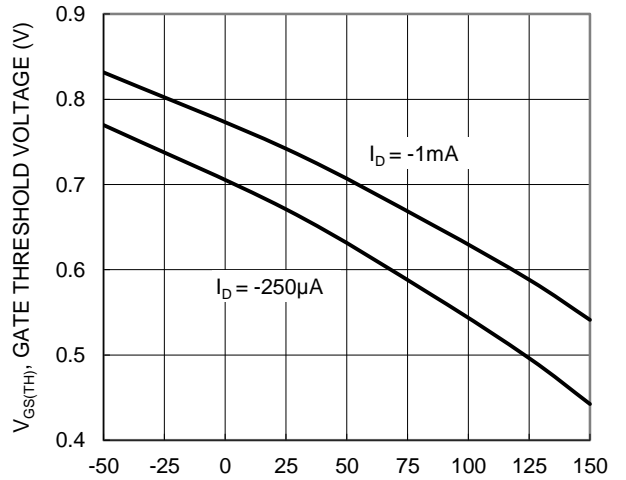

T<sub>J</sub>, JUNCTION TEMPERATURE (°C)  
Figure 8. Gate Threshold Variation vs. Junction Temperature

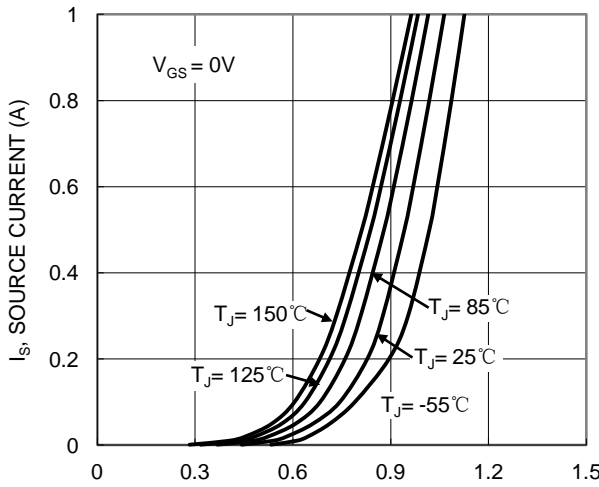

V<sub>SD</sub>, SOURCE-DRAIN VOLTAGE (V)  
Figure 9. Diode Forward Voltage vs. Current

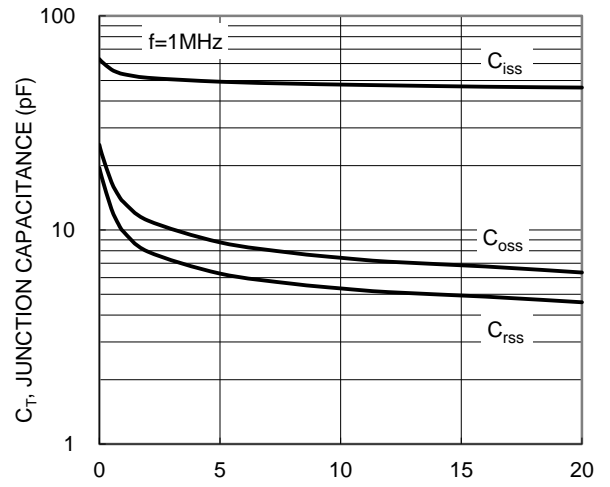

V<sub>DS</sub>, DRAIN-SOURCE VOLTAGE (V)  
Figure 10. Typical Junction Capacitance

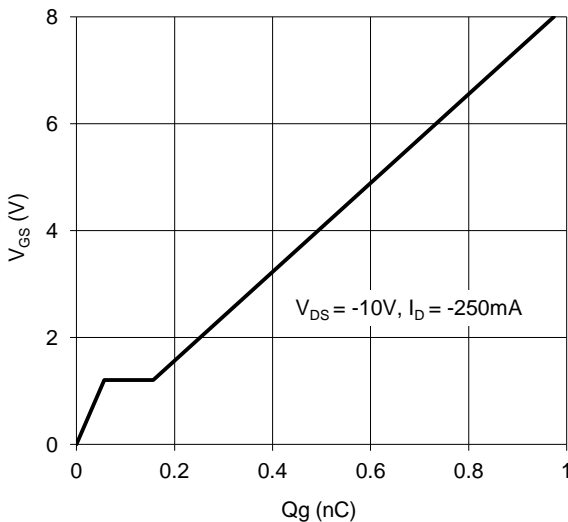
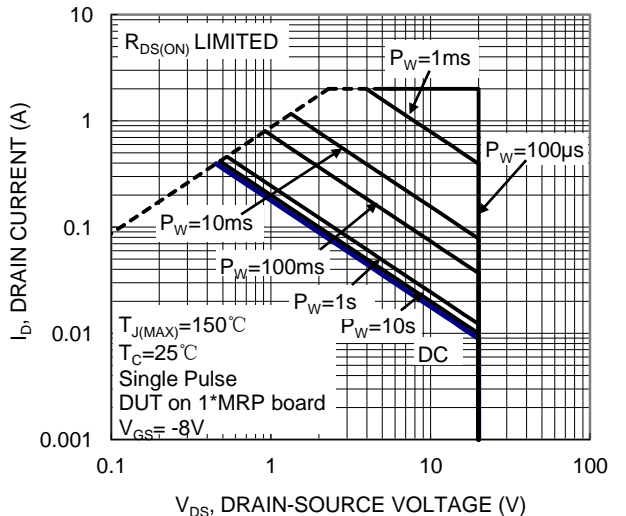

Figure 11. Gate Charge



V<sub>DS</sub>, DRAIN-SOURCE VOLTAGE (V)  
Figure 12. SOA, Safe Operation Area

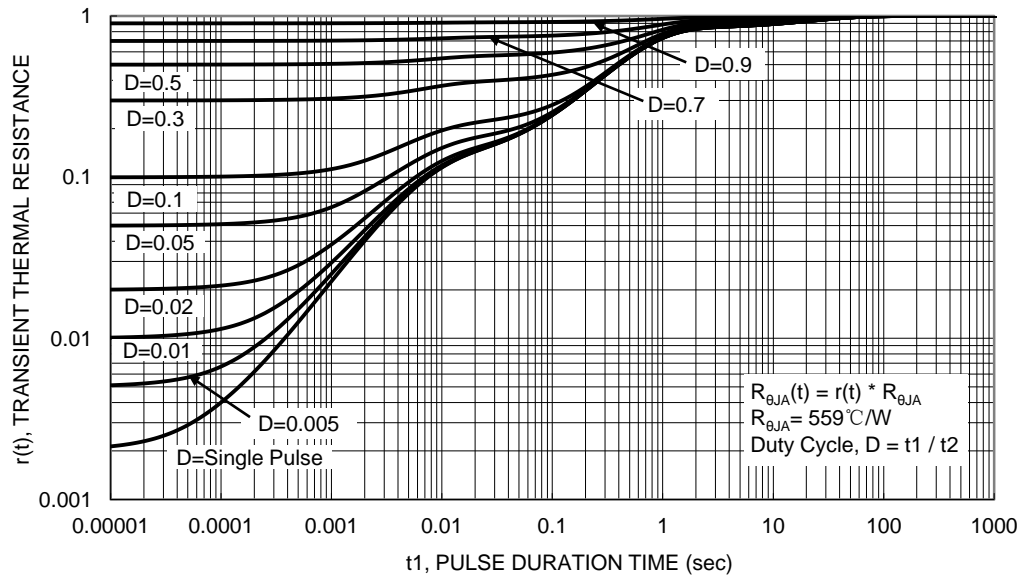
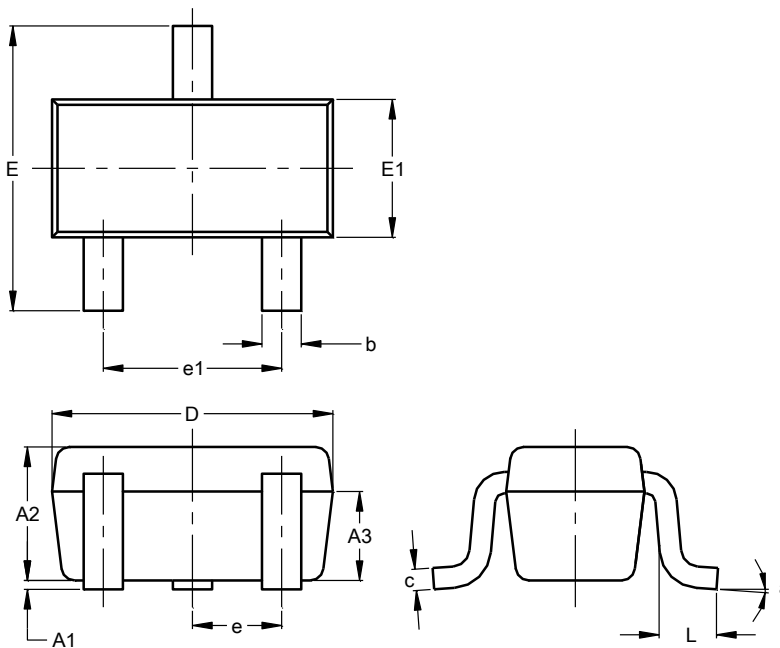

Figure 13. Transient Thermal Resistance

**Package Outline Dimensions**

Please see <http://www.diodes.com/package-outlines.html> for the latest version.

**SOT523**



SOT523			
Dim	Min	Max	Typ
A1	0.00	0.10	0.05
A2	0.60	0.80	0.75
A3	0.45	0.65	0.50
b	0.15	0.30	0.22
c	0.10	0.20	0.12
D	1.50	1.70	1.60
E	1.45	1.75	1.60
E1	0.75	0.85	0.80
e	0.50 BSC		
e1	0.90	1.10	1.00
L	0.20	0.40	0.33
a	0°	--	8°

**All Dimensions in mm**

## Suggested Pad Layout

Please see <http://www.diodes.com/package-outlines.html> for the latest version.

### SOT523

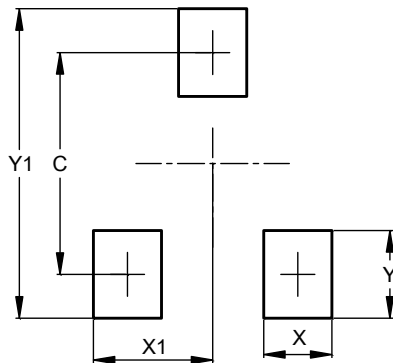

Dimensions	Value (in mm)
C	1.29
X	0.40
X1	0.70
Y	0.51
Y1	1.80

### IMPORTANT NOTICE

DIODES INCORPORATED MAKES NO WARRANTY OF ANY KIND, EXPRESS OR IMPLIED, WITH REGARDS TO THIS DOCUMENT, INCLUDING, BUT NOT LIMITED TO, THE IMPLIED WARRANTIES OF MERCHANTABILITY AND FITNESS FOR A PARTICULAR PURPOSE (AND THEIR EQUIVALENTS UNDER THE LAWS OF ANY JURISDICTION).

Diodes Incorporated and its subsidiaries reserve the right to make modifications, enhancements, improvements, corrections or other changes without further notice to this document and any product described herein. Diodes Incorporated does not assume any liability arising out of the application or use of this document or any product described herein; neither does Diodes Incorporated convey any license under its patent or trademark rights, nor the rights of others. Any Customer or user of this document or products described herein in such applications shall assume all risks of such use and will agree to hold Diodes Incorporated and all the companies whose products are represented on Diodes Incorporated website, harmless against all damages.

Diodes Incorporated does not warrant or accept any liability whatsoever in respect of any products purchased through unauthorized sales channel. Should Customers purchase or use Diodes Incorporated products for any unintended or unauthorized application, Customers shall indemnify and hold Diodes Incorporated and its representatives harmless against all claims, damages, expenses, and attorney fees arising out of, directly or indirectly, any claim of personal injury or death associated with such unintended or unauthorized application.

Products described herein may be covered by one or more United States, international or foreign patents pending. Product names and markings noted herein may also be covered by one or more United States, international or foreign trademarks.

This document is written in English but may be translated into multiple languages for reference. Only the English version of this document is the final and determinative format released by Diodes Incorporated.

### LIFE SUPPORT

Diodes Incorporated products are specifically not authorized for use as critical components in life support devices or systems without the express written approval of the Chief Executive Officer of Diodes Incorporated. As used herein:

A. Life support devices or systems are devices or systems which:

1. are intended to implant into the body, or
2. support or sustain life and whose failure to perform when properly used in accordance with instructions for use provided in the labeling can be reasonably expected to result in significant injury to the user.

B. A critical component is any component in a life support device or system whose failure to perform can be reasonably expected to cause the failure of the life support device or to affect its safety or effectiveness.

Customers represent that they have all necessary expertise in the safety and regulatory ramifications of their life support devices or systems, and acknowledge and agree that they are solely responsible for all legal, regulatory and safety-related requirements concerning their products and any use of Diodes Incorporated products in such safety-critical, life support devices or systems, notwithstanding any devices- or systems-related information or support that may be provided by Diodes Incorporated. Further, Customers must fully indemnify Diodes Incorporated and its representatives against any damages arising out of the use of Diodes Incorporated products in such safety-critical, life support devices or systems.

Copyright © 2018, Diodes Incorporated

[www.diodes.com](http://www.diodes.com)