



WIDEBAND FIXED-GAIN AMPLIFIER

FEATURES

- Fixed Closed-Loop Gain Amplifier
 - 10 V/V (20 dB)
- Wide Bandwidth: 1.8 GHz
- High Slew Rate: 5500 V/ μ s
- Low Total Input Referred Noise: 2.5 nV/ $\sqrt{\text{Hz}}$
- Low Distortion
 - HD₂: –65 dBc at 70 MHz
 - HD₃: –76 dBc at 70 MHz
 - IMD₃: –85 dBc at 100 MHz
 - OIP₃: 34 dBm at 100 MHz
 - IMD₃: –70 dBc at 300 MHz
 - OIP₃: 27 dBm at 300 MHz
- High Output Drive: \pm 180 mA
- Power Supply Voltage: 3 V or 5 V

APPLICATIONS

- Wideband Signal Processing
- Wireless Transceivers
- IF Amplifier
- ADC Preamplifier
- DAC Output Buffers
- Test, Measurement, and Instrumentation
- Medical and Industrial Imaging

DESCRIPTION

The THS4303 device is a wideband, fixed-gain amplifier that offers high bandwidth, high slew rate, low noise, and low distortion. This combination of specifications enables analog designers to transcend current performance limitations and process analog signals at much higher speeds than previously possible with closed-loop, complementary amplifier designs. The devices are offered in a 16-pin leadless package and incorporate a power-down mode for quiescent power savings.

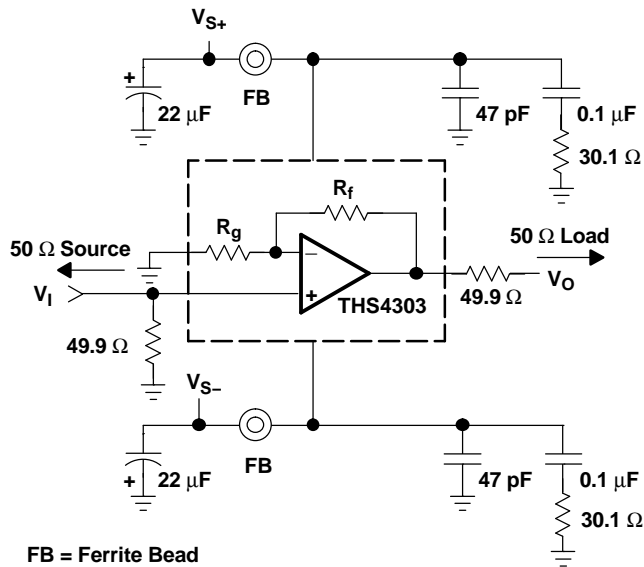

SMALL SIGNAL FREQUENCY RESPONSE

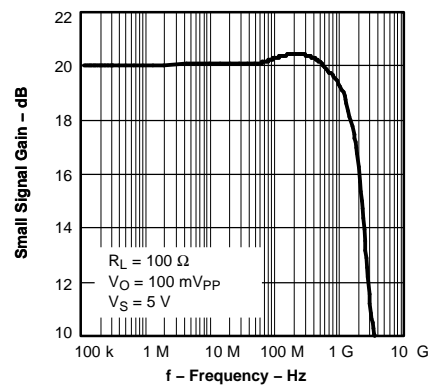

Please be aware that an important notice concerning availability, standard warranty, and use in critical applications of Texas Instruments semiconductor products and disclaimers thereto appears at the end of this data sheet.

PowerPAD is a trademark of Texas Instruments.



This integrated circuit can be damaged by ESD. Texas Instruments recommends that all integrated circuits be handled with appropriate precautions. Failure to observe proper handling and installation procedures can cause damage.

ESD damage can range from subtle performance degradation to complete device failure. Precision integrated circuits may be more susceptible to damage because very small parametric changes could cause the device not to meet its published specifications.

ABSOLUTE MAXIMUM RATINGS

over operating free-air temperature range unless otherwise noted⁽¹⁾

		UNIT
V_S	Supply voltage	6 V
V_I	Input voltage	$\pm V_S$
I_O	Output current	200 mA
Continuous power dissipation See Dissipation Rating Table		
$T_{J(2)}$	Maximum junction temperature	150°C
$T_{J(3)}$	Maximum junction temperature, continuous operation, longterm reliability	125°C
T_A	Operating free-air temperature range	-40°C to 85°C
T_{stg}	Storage temperature range	-65°C to 150°C
Lead temperature 1,6 mm (1/16 inch) from case for 10 seconds		300°C
ESD ratings:		
HBM		3000
CDM		1500
MM		200

- (1) Stresses above these ratings may cause permanent damage. Exposure to absolute maximum conditions for extended periods may degrade device reliability. These are stress ratings only, and functional operation of the device at these or any other conditions beyond those specified is not implied.
- (2) The THS4303 device may incorporate a PowerPAD™ on the underside of the chip. This acts as a heatsink and must be connected to a thermally dissipative plane for proper power dissipation. Failure to do so may result in exceeding the maximum junction temperature which can permanently damage the device. See TI technical brief SLMA002 and SLMA004 for more information about utilizing the PowerPAD thermally enhanced package.
- (3) The absolute maximum temperature under any condition is limited by the constraints of the silicon process.

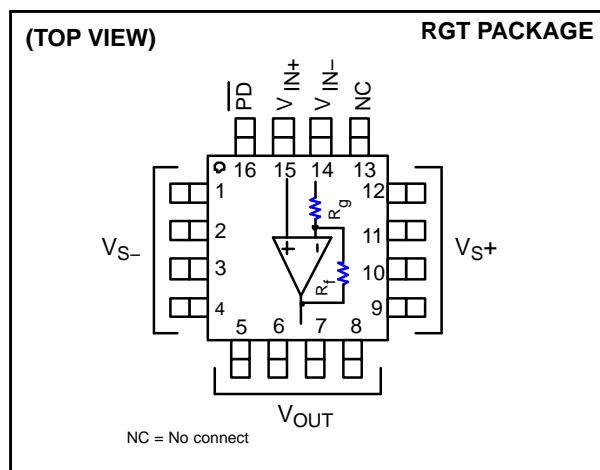

RECOMMENDED OPERATING CONDITIONS⁽¹⁾

		MIN	MAX	UNIT
Supply voltage, (VS+ and VS–)	Dual supply	±1.5	±2.5	V
	Single supply	3	5	
Input common-mode voltage range		$V_{S-}+1$	$V_{S+}-1$	V

- (1) This data was taken using 2 oz. trace and copper pad that is soldered directly to a 3 in. x 3 in. PCB. For further information, refer to *Application Information* section of this data sheet.

PACKAGE DISSIPATION RATINGS

PACKAGE	Θ_{JC} (°C/W)	Θ_{JA} (°C/W)	POWER RATING ⁽¹⁾	
			$T_A \leq 25^\circ\text{C}$	$T_A = 85^\circ\text{C}$
RGT-16 ⁽²⁾	2.4	39.5	2.53 W	1.01 W

- (1) Power rating is determined with a junction temperature of 125°C. This is the point where distortion starts to substantially increase. Thermal management of the final PCB should strive to keep the junction temperature at or below 125°C for best performance and long term reliability.
- (2) This data was taken using 2 oz. trace and copper pad that is soldered directly to a 3 in. x 3 in. PCB. For further information, refer to *Application Information* section of this data sheet.

AVAILABLE OPTIONS

T_A	PACKAGED DEVICES ⁽¹⁾	
	LEADLESS	
	GAIN	RGT-16
–40°C to 85°C	+10	THS4303RGTR
		THS4303RGTT

- (1) Packages are available taped and reeled. The R suffix standard quantity is 3000. The T suffix standard quantity is 250.

INTERNAL FIXED RESISTOR VALUES

DEVICE	GAIN (V/V)	R_f	R_g
THS4303	+10	450	50

ELECTRICAL CHARACTERISTICS

THS4303 (Gain = +10 V/V) Specifications: $V_S = 5\text{ V}$, $R_L = 100\ \Omega$, (unless otherwise noted)

PARAMETER	TEST CONDITIONS	TYP	OVER TEMPERATURE				UNITS	MIN/ MAX
		25°C	25°C	0°C to 70°C	-40°C to 85°C			
AC PERFORMANCE								
Small signal bandwidth	$G = +10$, $V_O = 200\text{ mV}_{\text{RMS}}$	1.8					GHz	Typ
Gain bandwidth product		18					GHz	Typ
Full-power bandwidth	$G = +10$, $V_O = 2\text{ V}_{\text{pp}}$	1.5					GHz	Typ
Slew rate	$G = +10$, $V_O = 2\text{ V Step}$	5500					V/ μs	Min
Harmonic distortion								
Second harmonic distortion	$G = +10$, $V_O = 1\text{ V}_{\text{PP}}$, $f = 70\text{ MHz}$	$R_L = 100\ \Omega$	-65				dBc	Typ
		$R_L = 1\text{ k}\Omega$	-75					
Third harmonic distortion	$G = +10$, $V_O = 1\text{ V}_{\text{PP}}$, $f = 70\text{ MHz}$	$R_L = 100\ \Omega$	-76				dBc	Typ
		$R_L = 1\text{ k}\Omega$	-80					
Third order intermodulation (IMD ₃)	$V_O = 1\text{ V}_{\text{PP}}$ envelope, 200 kHz tone spacing	$f_c = 100\text{ MHz}$	-85				dBc	Typ
		$f_c = 300\text{ MHz}$	-70					
Third order output intercept (OIP ₃)	$V_O = 1\text{ V}_{\text{PP}}$, 200 kHz tone spacing	$f_c = 100\text{ MHz}$	34				dBm	Typ
		$f_c = 300\text{ MHz}$	27					
Total input referred noise	$f = 1\text{ MHz}$	2.5					nV/ $\sqrt{\text{Hz}}$	Typ
Noise figure	$f = 100\text{ MHz}$	16					dB	Typ
DC PERFORMANCE								
Voltage gain	$V_I = \pm 50\text{ mV}$, $V_{\text{CM}} = 2.5\text{ V}$	9.9	9.8	9.8	9.8		V/V	Min
		9.9	10	10	10			V/V
Input offset voltage	$V_{\text{CM}} = 2.5\text{ V}$	1.5	4.25	5.25	5.25		mV	Max
Average offset voltage drift				± 20	± 20		$\mu\text{V}/^\circ\text{C}$	Typ
Input bias current		7	10	13	15		μA	Max
Average bias current drift				± 55	± 55		nA/ $^\circ\text{C}$	Typ
INPUT CHARACTERISTICS								
Common-mode input range		1 / 4	1.1 / 3.9	1.2 / 3.8	1.2 / 3.8		V	Min
Common-mode rejection ratio	$V_{\text{CM}} = 2\text{ V to } 3\text{ V}$	60	52	50	50		dB	Min
Noninverting input impedance		1.6 1					M Ω pF	Typ
OUTPUT CHARACTERISTICS								
Output voltage swing		1 / 4	1.1 / 3.9	1.2 / 3.8	1.2 / 3.8		V	Min
Output current (sourcing)	$R_L = 5\ \Omega$	180	170	165	160		mA	Min
Output current (sinking)	$R_L = 5\ \Omega$	180	170	165	160		mA	Min
Output impedance	$f = 10\text{ MHz}$	0.08					Ω	Typ
POWER SUPPLY								
Specified operating voltage		5	5.5	5.5	5.5		V	Max
Maximum quiescent current		34	41	46	48		mA	Max
Minimum quiescent current		34	27	25	23		mA	Min
Power supply rejection (PSRR +)	$V_{\text{S}+} = 5\text{ V to } 4.5\text{ V}$, $V_{\text{S}-} = 0\text{ V}$	63	54	52	51		dB	Min
Power supply rejection (PSRR -)	$V_{\text{S}+} = 5\text{ V}$, $V_{\text{S}-} = 0\text{ V to } 0.5\text{ V}$	65	58	56	54		dB	Min

ELECTRICAL CHARACTERISTICS (continued)

THS4303 (Gain = +10 V/V) Specifications: $V_S = 5\text{ V}$, $R_L = 100\ \Omega$, (unless otherwise noted)

PARAMETER	TEST CONDITIONS	TYP	OVER TEMPERATURE				UNITS	MIN/ MAX
		25°C	25°C	0°C to 70°C	-40°C to 85°C			
POWER-DOWN CHARACTERISTICS								
Maximum power-down current	$\overline{PD} = 0\text{ V}$	0.9	1.2	1.3	1.4	mA	Max	
Power-on voltage threshold		1.1	1.5			V	Min	
Power-down voltage threshold		1.1	0.9			V	Max	
Turnon time delay [t_{ON}]	90% of final value	42				ns	Typ	
Turnoff time delay [t_{OFF}]	10% of final value	35				ns	Typ	
Input impedance		100				k Ω	Typ	
Output impedance	$f = 100\text{ kHz}$	470				Ω	Typ	

SCHEMATIC DIAGRAM

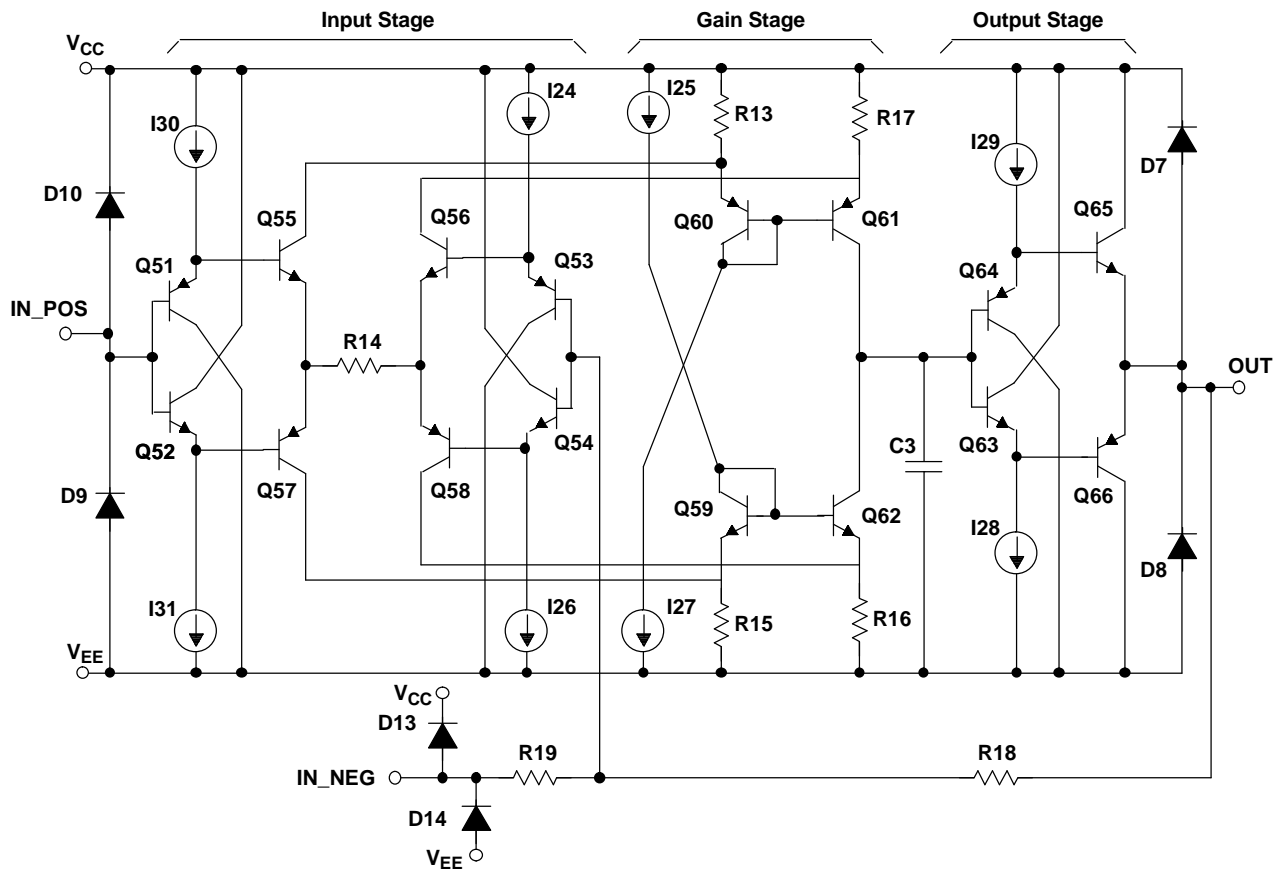

TYPICAL CHARACTERISTICS**TABLE OF GRAPHS (5 V)**

	FIGURE
S-parameter vs Frequency	1
Small signal frequency response	2
Large signal frequency response	3
Slew rate vs Output voltage	4
Harmonic distortion vs Frequency	5, 6
Harmonic distortion vs Output voltage swing	7
Second order intermodulation distortion vs Frequency	8
Third order intermodulation distortion vs Frequency	9
Second order intercept point vs Frequency	10
Third order intercept point vs Frequency	11
Voltage and current noise vs Frequency	12
Settling time	13, 14
Quiescent current vs Supply voltage	15
Output voltage vs Load resistance	16
Capacitive load frequency response	17
Gain vs Case temperature	18
Rejection ratio vs vs Frequency	19
Rejection ratios vs Case temperature	20
Common-mode rejection ratio vs Input common-mode range	21
Input offset voltage vs Case temperature	22
Positive input bias current vs Case temperature	23
Small signal transient response	24
Large signal transient response	25
Overdrive recovery	26
Closed-loop output impedance vs Frequency	27
Power-down quiescent current vs Supply voltage	28
Power-down S-parameter vs Frequency	29
Power-down output impedance vs Frequency	30
Turnon and turnoff delay times	31

TABLE OF GRAPHS (3 V)

	FIGURE
S-parameter vs Frequency	32
Small signal frequency response	33
Large signal frequency response	34
Harmonic distortion vs Frequency	35
Slew rate vs Output voltage	36
Capacitive load frequency response	37
Gain vs Case temperature	38
Input offset voltage vs Case temperature	39
Positive input bias current vs Case temperature	40
Overdrive recovery	41
Power-down S-parameter vs Frequency	42

TYPICAL TEST DATA

S-Parameter (Measured using standard THS4303EVM, edge number 6454762, with $V_S = 5\text{ V}$ in a $50\ \Omega$ test system)								
Frequency (MHz)	S11 (dB)	S11 (Ang)	S21 (dB)	S21 (Ang)	S12 (dB)	S12 (Ang)	S22 (dB)	S22 (Ang)
1	-50.68359	-9.936035	20.07422	1.007886	-75.9375	74.27344	-52.6047	-9.367676
2	-50.80664	-3.452515	20.08398	2.060587	-77.44531	-30.31445	-51.9668	8.862793
10	-51.10547	-38.07227	20.02734	10.158346	-80.94922	53.79102	-47.64258	42.5957
50	-37.71289	-76.30078	20.08252	50.078859	-63.52539	-72.41406	-59.52539	-91.70703
100	-34.61719	-109.6055	20.29541	102.38457	-57.58594	74.66016	-30.39063	125.332
150	-31.50684	-105.7422	20.40576	150.47685	-52.71875	18.20898	-24.91895	102.4297
200	-29.81348	-105.3516	20.44922	198.11759	-53.94141	53.86523	-22.96484	89.09766
250	-29.20801	-129.6016	20.43213	246.87998	-52.35938	40.63672	-22.02344	79.55469
300	-26.57422	-100.0703	20.40088	307.6446	-54.19336	81.05859	-21.18359	73.59766
350	-25.90137	-102.1328	20.34033	362.84524	-53.47266	-38.93164	-20.597766	71.20313
400	-24.89551	-111.4609	20.2959	405.04485	-54.37109	12.90479	-20.03906	71.91797
450	-24.7002	-76.46094	20.22754	452.15154	-53.91797	14.76416	-19.84668	74.58203
500	-25.76758	-95.54688	20.16406	504.73809	-55.60156	34.66016	-19.11621	73.60547
550	-24.86231	-98.39844	20.05273	563.4396	-57.78125	-114.1016	-18.54688	78.37109
600	-23.49805	-106.6992	19.97656	595.30346	-61.00977	-60.50586	-18.15332	76.28125
700	-21.07422	-84.68359	19.76318	702.11941	-64.83984	-67.44531	-17.24609	79.64063
800	-19.82617	-86.29688	19.60352	828.09966	-72.0625	72.92578	-15.36182	84.96875
900	-18.98828	-86.40625	19.44287	924.40782	-61.43359	172.7109	-14.03223	87.03125
1000	-17.16211	-82.15234	19.24219	1031.9205	-54.25391	165.2578	-12.65723	87.64844
1250	-14.66065	-83.30469	18.59424	1285.9052	-46.52148	163.7813	-10.12158	81.31641
1500	-12.67529	-90.48438	17.96533	1516.6333	-41.23242	159.5156	-8.850586	79.875
1750	-11.51025	-104.2656	17.229	1788.7621	-37.59766	145.8125	-7.762695	76.54688
2000	-10.52832	-106.4531	16.30127	1996.8001	-35.54688	154.1719	-7.215088	76.26953

TYPICAL THS4303 CHARACTERISTICS (5 V)

S-PARAMETER
VS
FREQUENCY

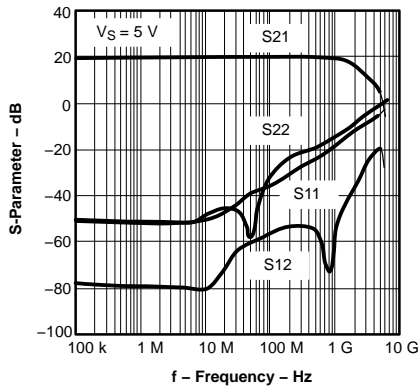

Figure 1.

SMALL SIGNAL
FREQUENCY RESPONSE

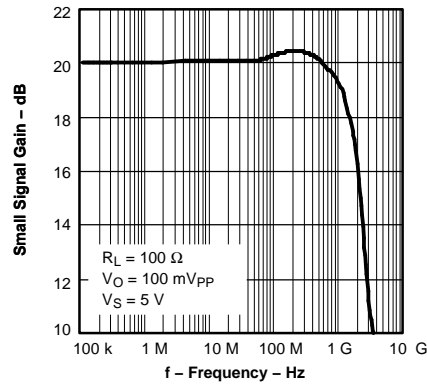

Figure 2.

LARGE SIGNAL
FREQUENCY RESPONSE

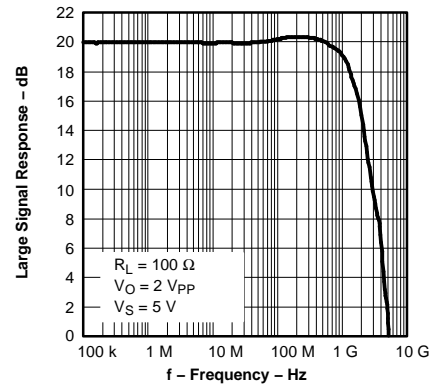

Figure 3.

SLEW RATE
VS
OUTPUT VOLTAGE

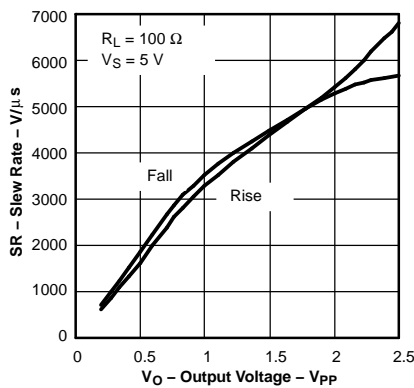

Figure 4.

HARMONIC DISTORTION
VS
FREQUENCY

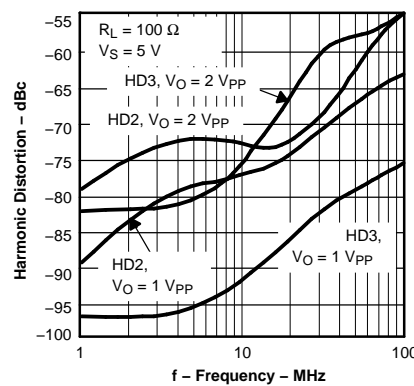

Figure 5.

HARMONIC DISTORTION
VS
FREQUENCY

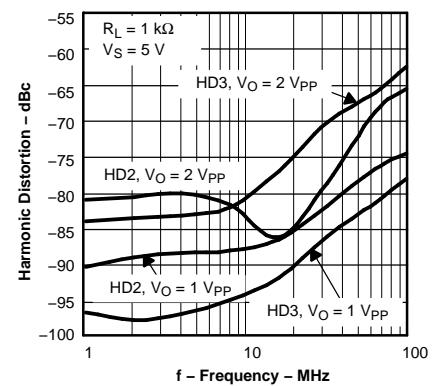

Figure 6.

HARMONIC DISTORTION
VS
OUTPUT VOLTAGE SWING

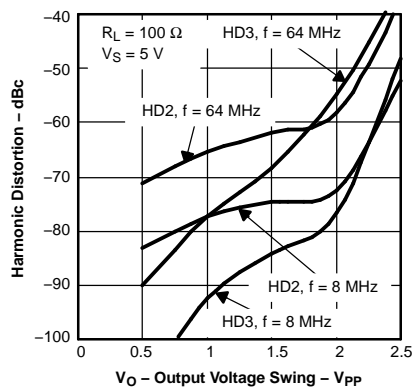

Figure 7.

SECOND-ORDER
INTERMODULATION DISTORTION
VS
FREQUENCY

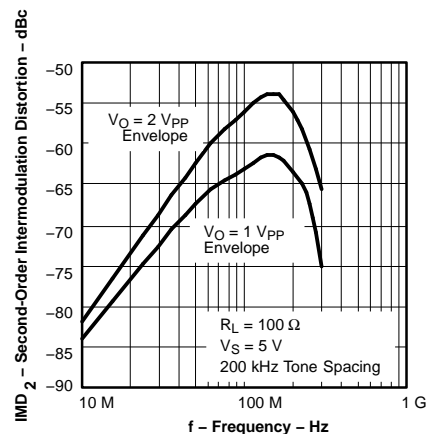

Figure 8.

THIRD-ORDER
INTERMODULATION DISTORTION
VS
FREQUENCY

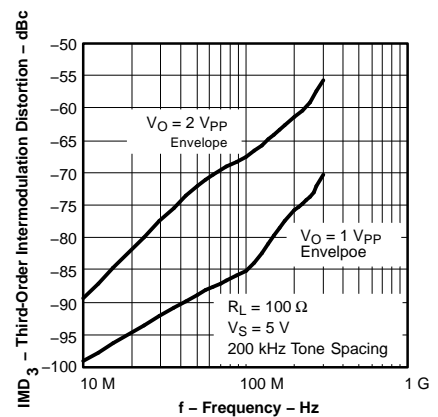

Figure 9.

TYPICAL THS4303 CHARACTERISTICS (5 V) (continued)

SECOND-ORDER
OUTPUT INTERCEPT
VS
FREQUENCY

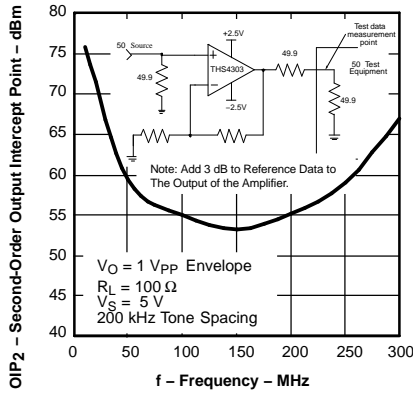

Figure 10.

THIRD-ORDER OUTPUT INTERCEPT
VS
FREQUENCY

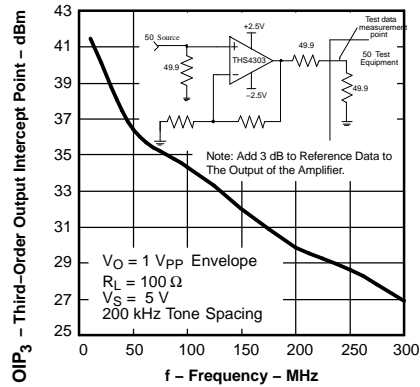

Figure 11.

VOLTAGE AND CURRENT NOISE
VS
FREQUENCY

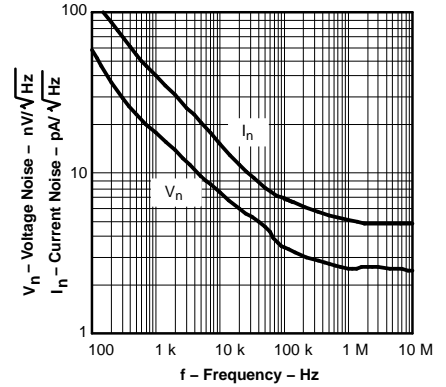

Figure 12.

SETTLING TIME

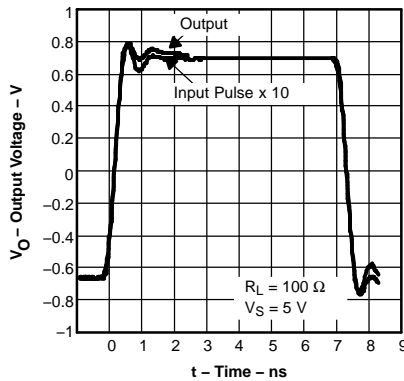

Figure 13.

SETTLING TIME

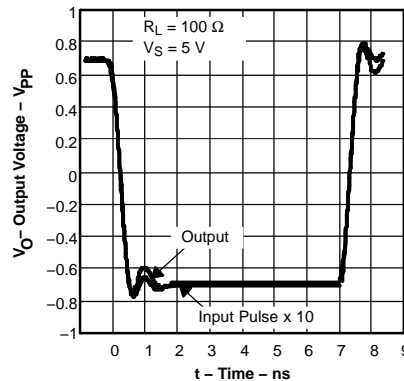

Figure 14.

QUIESCENT CURRENT
VS
SUPPLY VOLTAGE

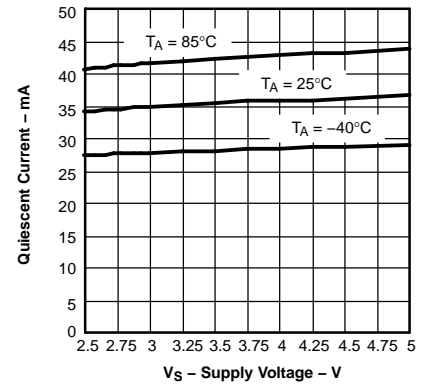

Figure 15.

OUTPUT VOLTAGE
VS
LOAD RESISTANCE

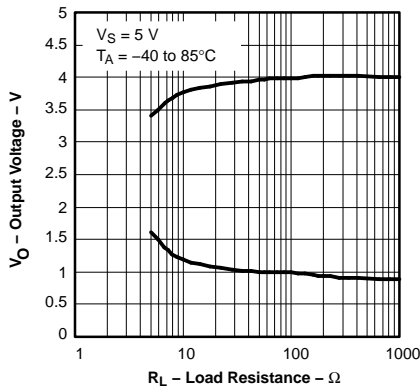

Figure 16.

CAPACITIVE LOAD FREQUENCY
RESPONSE

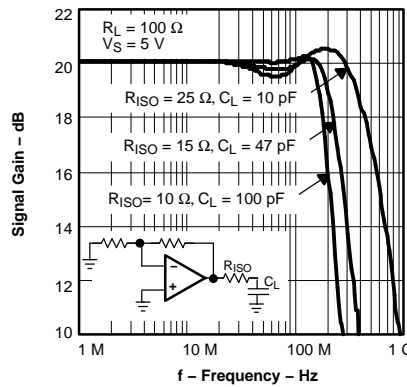

Figure 17.

GAIN
VS
CASE TEMPERATURE

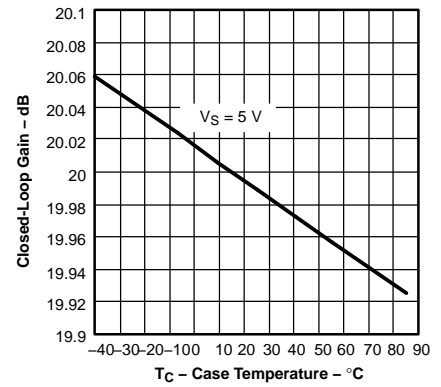

Figure 18.

TYPICAL THS4303 CHARACTERISTICS (5 V) (continued)

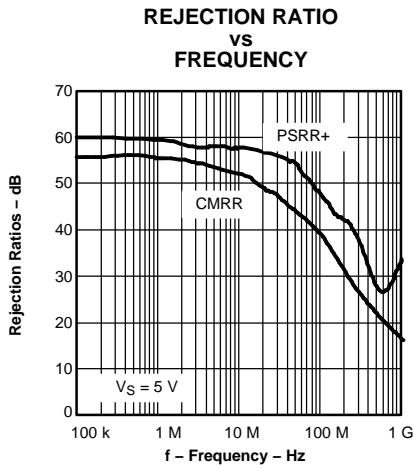

Figure 19.

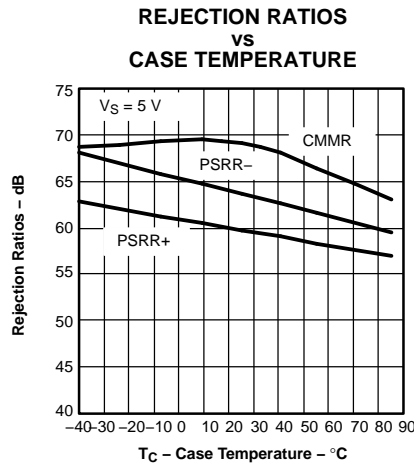

Figure 20.

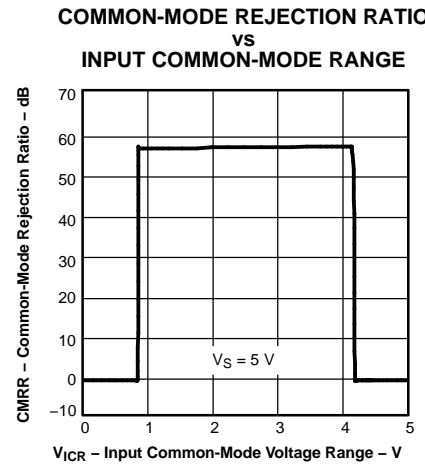

Figure 21.

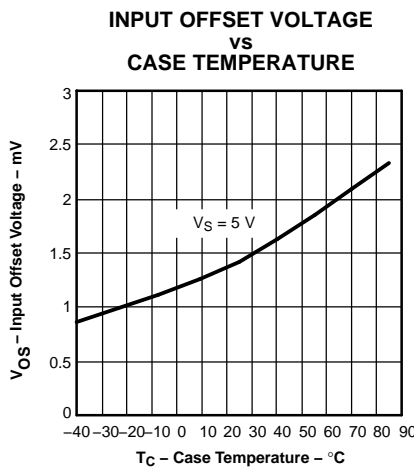

Figure 22.

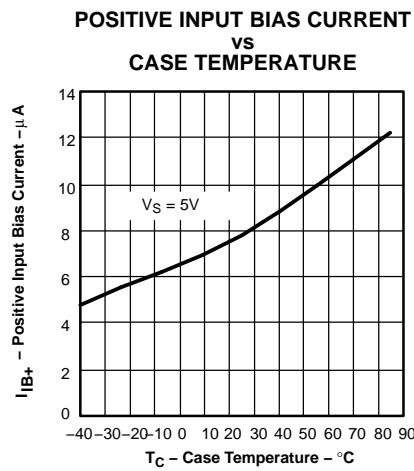

Figure 23.

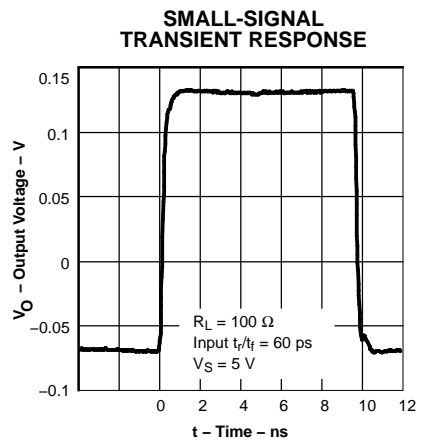

Figure 24.

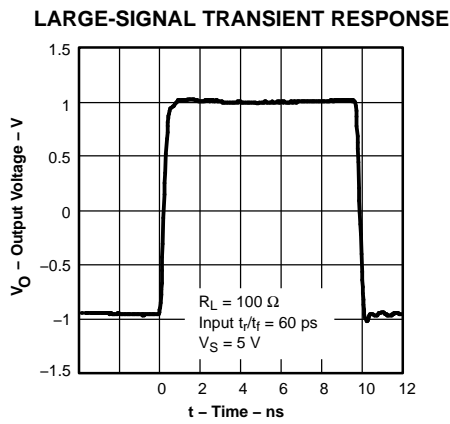

Figure 25.

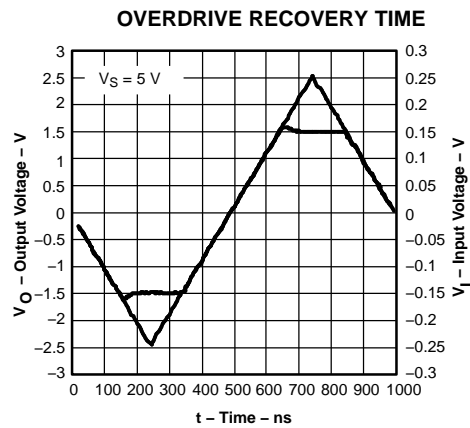

Figure 26.

TYPICAL THS4303 CHARACTERISTICS (5 V) (continued)

CLOSED-LOOP OUTPUT IMPEDANCE VS FREQUENCY

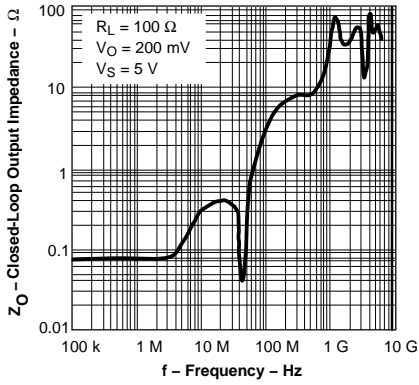

Figure 27.

POWER-DOWN QUIESCENT CURRENT VS SUPPLY VOLTAGE

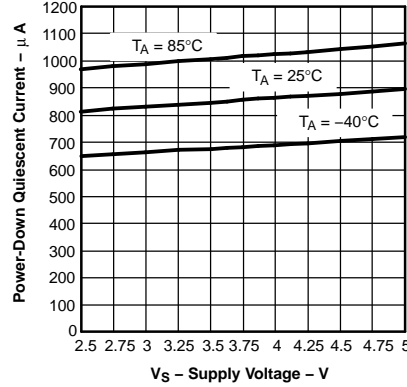

Figure 28.

POWER-DOWN S-PARAMETER VS FREQUENCY

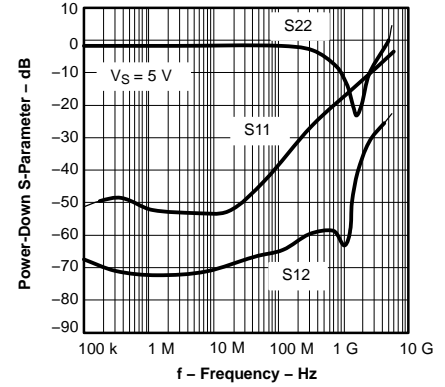

Figure 29.

POWER-DOWN OUTPUT IMPEDANCE VS FREQUENCY

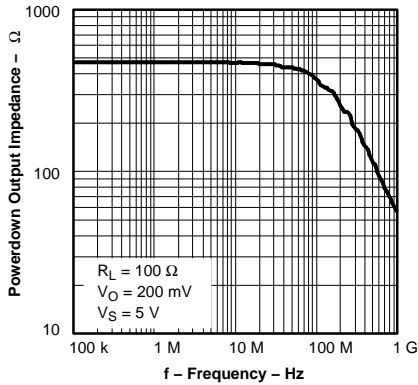

Figure 30.

TURN-ON AND TURN-OFF TIMES DELAY TIME

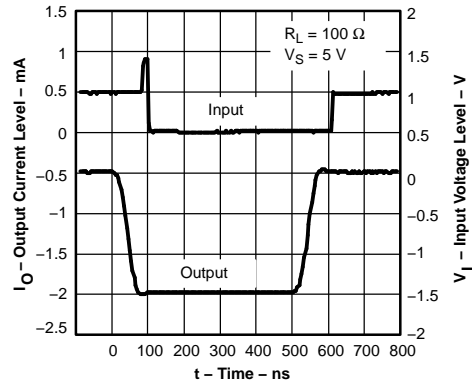

Figure 31.

TYPICAL THS4303 CHARACTERISTICS (3 V)

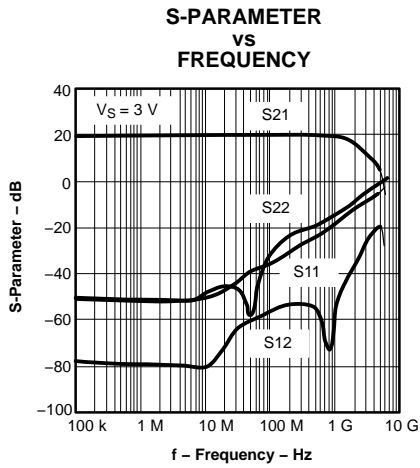

Figure 32.

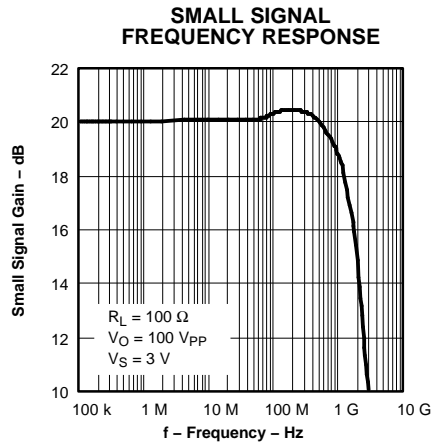

Figure 33.

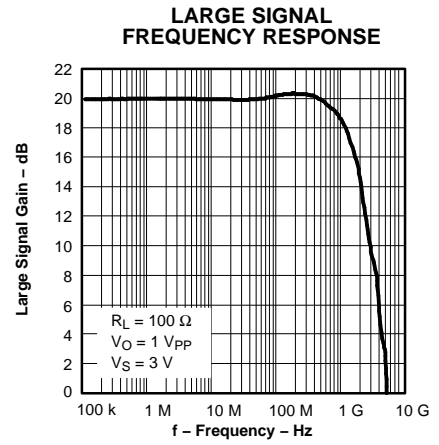

Figure 34.

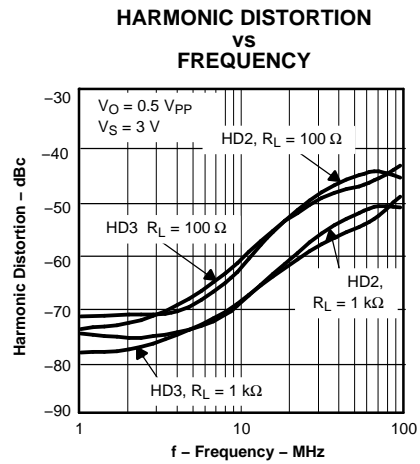

Figure 35.

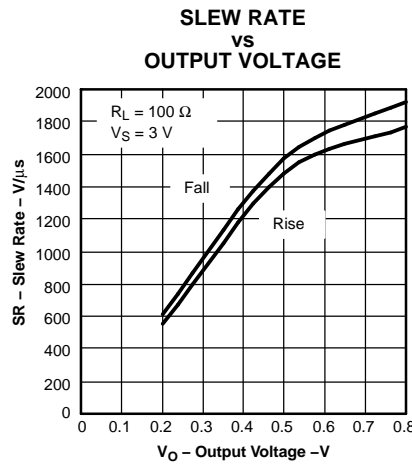

Figure 36.

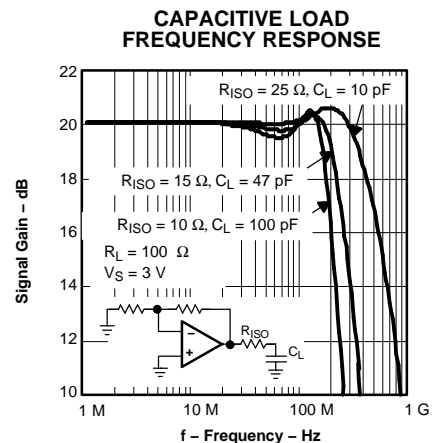

Figure 37.

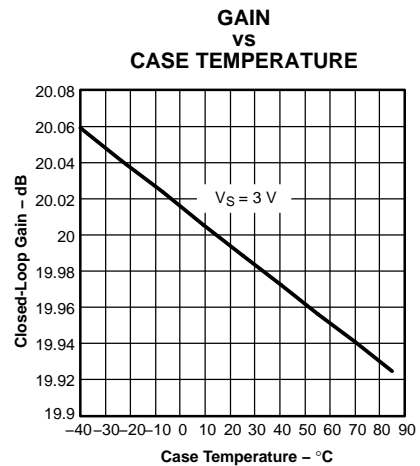

Figure 38.

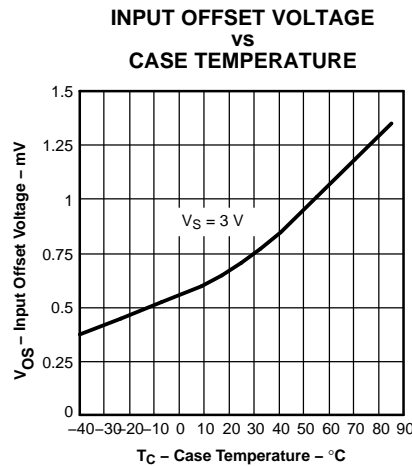

Figure 39.

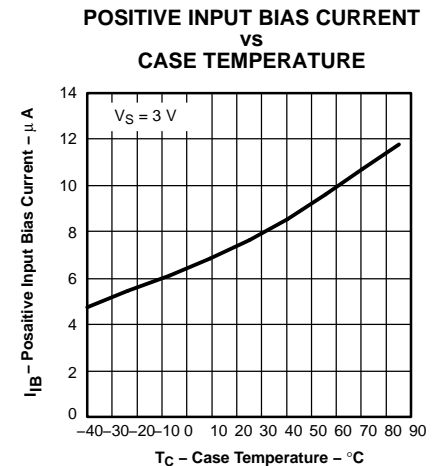

Figure 40.

TYPICAL THS4303 CHARACTERISTICS (3 V) (continued)

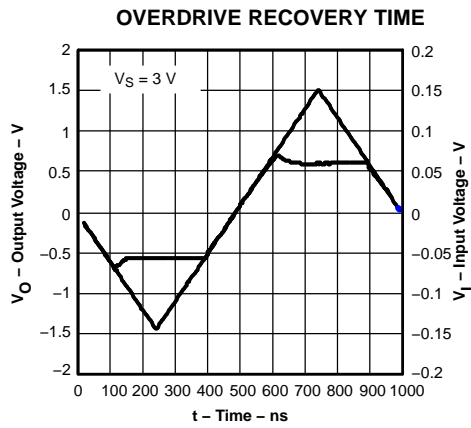

Figure 41.

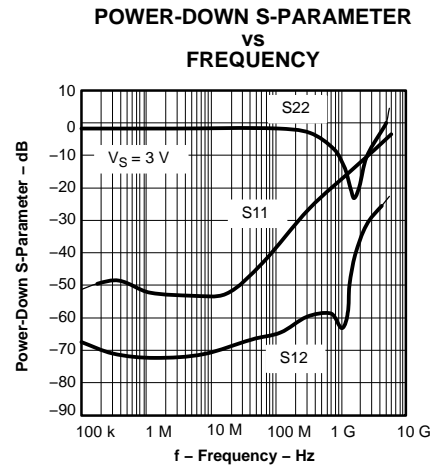

Figure 42.

APPLICATION INFORMATION

HIGH-SPEED OPERATIONAL AMPLIFIERS

The THS4303 fixed gain operational amplifier set new performance levels, combining low distortion, high slew rates, low noise, and a gain bandwidth in excess of 1.8 GHz. To achieve the full performance of the amplifier, careful attention must be paid to printed-circuit board layout and component selection.

In addition, the devices provide a power-down mode with the ability to save power when the amplifier is inactive.

APPLICATIONS SECTION CONTENTS

- Wideband, Noninverting Operation
- Single Supply Operation
- Saving Power With Power-Down Functionality
- Driving an ADC With the THS4303
- Driving Capacitive Loads
- Power Supply Decoupling Techniques and Recommendations
- Board Layout
- Printed-Circuit Board Layout Techniques for Optimal Performance
- PowerPAD Design Considerations
- PowerPAD PCB Layout Considerations
- Thermal Analysis
- Design Tools
- Evaluation Fixtures and Application Support Information
- Additional Reference Material
- Mechanical Package Drawings

WIDEBAND, NONINVERTING OPERATION

The THS4303 is a fixed gain voltage feedback operational amplifier, with power-down capability, designed to operate from a single 3-V to 5-V power supply.

Figure 43 is the noninverting gain configuration used to demonstrate the typical performance curves. Most of the curves were characterized using signal sources with 50-Ω source impedance, and with measurement equipment presenting a 50-Ω load impedance. In Figure 43, the 49.9-Ω shunt resistor at the V_{IN} terminal matches the source impedance of the test generator. The 50-Ω series resistor at the V_O terminal in addition to the 50-Ω load impedance of the test

equipment, provides a 100-Ω load. The total 100-Ω load at the output, combined with the 500-Ω total feedback network load, presents the THS4303 with an effective output load of 83 Ω for the circuit of Figure 43.

INTERNAL FIXED RESISTOR VALUES

DEVICE	GAIN (V/V)	R_f	R_g
THS4303	+10	450	50

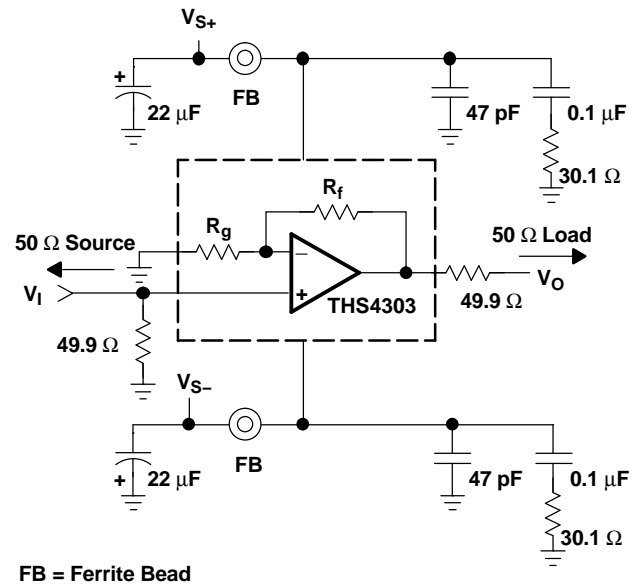

Figure 43. Wideband, Noninverting Gain Configuration

SINGLE SUPPLY OPERATION

The THS4303 is designed to operate from a single 3-V to 5-V power supply. When operating from a single power supply, care must be taken to ensure the input signal and amplifier are biased appropriately to allow for the maximum output voltage swing. The circuits shown in Figure 44 demonstrate methods to configure an amplifier in a manner conducive for single supply operation.

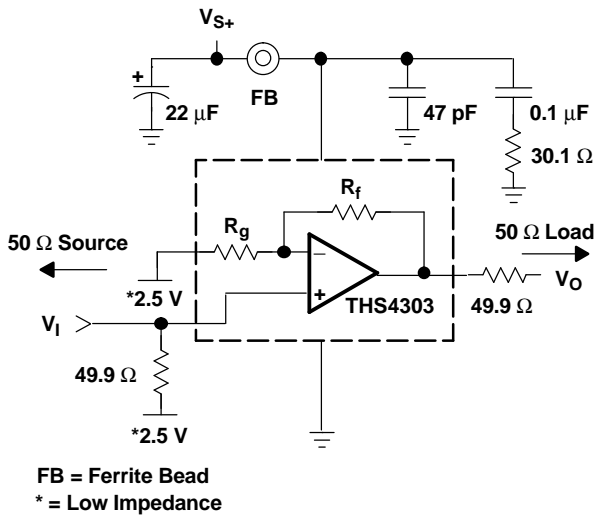

Figure 44. DC-Coupled Single Supply Operation

SAVING POWER WITH POWER-DOWN FUNCTIONALITY

The THS4303 features a power-down pin ($\overline{\text{PD}}$) which lowers the quiescent current from 34 mA down to 1 mA, ideal for reducing system power.

The power-down pin of the amplifier defaults to the positive supply voltage in the absence of an applied voltage, putting the amplifier in the power-on mode of operation. To turn off the amplifier in an effort to conserve power, the power-down pin can be driven towards the negative rail. The threshold voltages for power-on and power-down are relative to the supply rails and given in the specification tables. Above the *Enable Threshold Voltage*, the device is on. Below the *Disable Threshold Voltage*, the device is off. Behavior in between these threshold voltages is not specified.

Note that this power-down functionality is just that; the amplifier consumes less power in power-down mode. The power-down mode is not intended to provide a high-impedance output. In other words, the power-down functionality is not intended to allow use as a 3-state bus driver. When in power-down mode,

the impedance looking back into the output of the amplifier is dominated by the feedback and gain setting resistors, but the output impedance of the device itself varies depending on the voltage applied to the outputs.

The time delays associated with turning the device on and off are specified as the time it takes for the amplifier to reach 50% of the nominal quiescent current. The time delays are on the order of microseconds because the amplifier moves in and out of the linear mode of operation in these transitions.

APPLICATION CIRCUITS

DRIVING AN ANALOG-TO-DIGITAL CONVERTER WITH THE THS4303

The THS4303 amplifier can be used to drive high-performance analog-to-digital converters. Two example circuits are presented below.

The first circuit uses a wideband transformer to convert a single-ended input signal into a differential signal. The amplified signal from the output of the THS4303 is fed through a low-pass filter, via an isolation resistor and an ac-coupling capacitor, to the transformer.

For applications without signal content at dc, this method of driving ADCs is very useful. Where dc information content is required, the THS4500 family of fully differential amplifiers may be applicable.

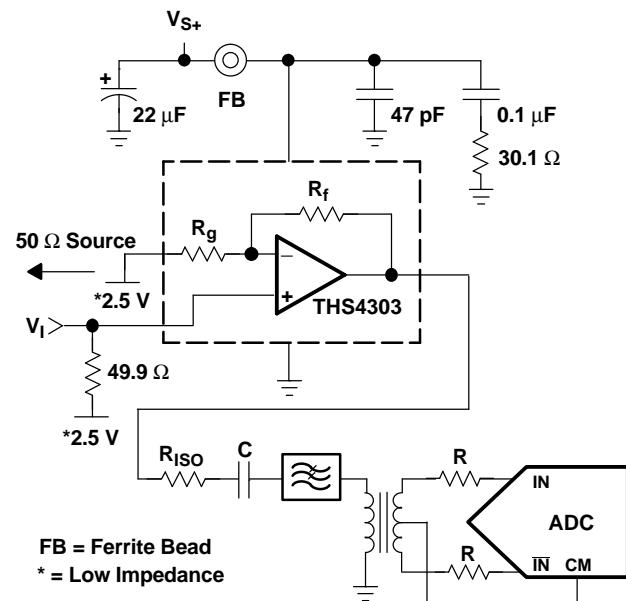

Figure 45. Driving an ADC Via a Transformer

The second circuit depicts single-ended ADC drive. While not recommended for optimum performance using converters with differential inputs, satisfactory performance can sometimes be achieved with single-ended input drive. An example circuit is shown here for reference.

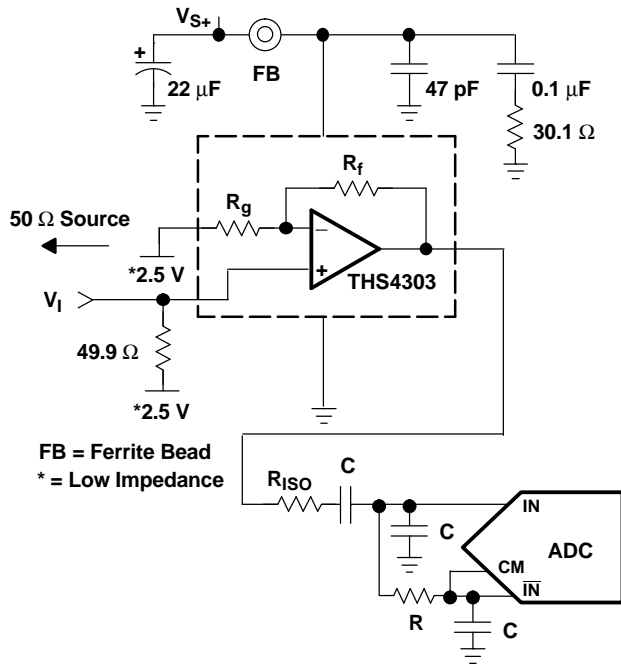

Figure 46. Driving an ADC With a Single-Ended Input

NOTE:

For best performance, high-speed ADCs should be driven differentially. See the THS4500 family of devices for more information.

DRIVING CAPACITIVE LOADS

One of the most demanding, and yet very common, load conditions for an op amp is capacitive loading. Often, the capacitive load is the input of an A/D converter, including additional external capacitance, which may be recommended to improve A/D linearity. High-speed amplifiers like the THS4303 can be very susceptible to decreased stability and closed-loop response peaking when a capacitive load is placed directly on the output pin. When the amplifier's open-loop output resistance is considered, this capacitive load introduces an additional pole in the signal path that can decrease the phase margin. When the primary considerations are frequency re-

sponse flatness, pulse response fidelity, or distortion, the simplest and most effective solution is to isolate the capacitive load from the feedback loop by inserting a series isolation resistor between the amplifier output and the capacitive load.

The Typical Characteristics show the recommended isolation resistor vs capacitive load and the resulting frequency response at the load. Parasitic capacitive loads greater than 2 pF can begin to degrade the performance of the THS4303. Long PC board traces, unmatched cables, and connections to multiple devices can easily cause this value to be exceeded. Always consider this effect carefully, and add the recommended series resistor as close as possible to the THS4303 output pin (see Board Layout Guidelines).

The criterion for setting this $R_{(ISO)}$ resistor is a maximum bandwidth, flat frequency response at the load.

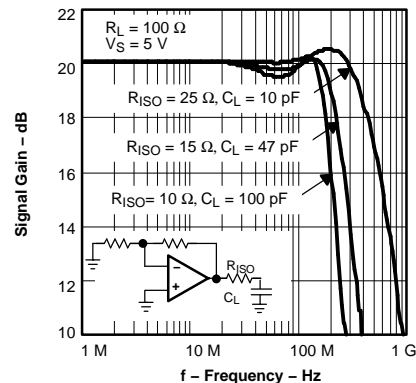

Figure 47. Driving Capacitive Loads

POWER SUPPLY DECOUPLING TECHNIQUES AND RECOMMENDATIONS

Power supply decoupling is a critical aspect of any high-performance amplifier design process. Careful decoupling provides higher quality ac performance (most notably improved distortion performance). The following guidelines ensure the highest level of performance.

1. Place decoupling capacitors as close to the power supply inputs as possible, with the goal of minimizing the inductance of the path from ground to the power supply. Inductance in series with the bypass capacitors will degrade performance. Note that a narrow lead or trace has about 0.8 nH of inductance for every millimeter of length. Each printed-circuit board (PCB) via also has between 0.3 and 0.8 nH depending on length and diameter. For these reasons, it is recommended to use a power supply trace about the width of the package for each power supply lead

to the caps, and 3 or more vias to connect the caps to the ground plane.

2. Placement priority should put the smallest valued capacitors closest to the device.
3. Solid power planes can lead to PCB resonances when they are not properly terminated to the ground plane over the area and along the perimeter of the power plane by high frequency capacitors. Doing so assures that there are no power plane resonances in the needed frequency range. Values used are in the range of 2 pF - 50 pF, depending on the frequencies to be suppressed, with numerous vias for each.
4. Using 0402 or smaller component sizes is recommended. An approximate expression for the resonate frequencies associated with a length of one of the power plane dimensions is given in equation (1). Note that a power plane of arbitrary shape can have a number of resonant frequencies. A power plane without distributed capacitors and with active parts near the center of the plane usually has n even (≥ 2) due to the half wave resonant nature of the plane.

$$\text{frequency}_{\text{res}} \approx \frac{n \times (44 \text{ GHz mm})}{\ell}$$

where:

frequency_{res} = the approximate power plane resonant frequencies in GHz

ℓ = the length of the power plane dimensions in millimeters

n = an integer ($n > 1$) related to the mode of the oscillation

- For guidance on capacitor spacing over the area of the ground plane, specify the lowest resonant frequency to be tolerated, then solve for in equation (1) above, with $n = 2$. Use this length for the capacitor spacing. It is recommended that a power plane, if used, be either small enough, or decoupled as described, so that there are no resonances in the frequency range of interest. An alternative is to use a ferrite bead outside of the opamp high frequency bypass caps to decouple the amplifier, and mid and high frequency bypass capacitors, from the power plane. When a trace is used to deliver power, its self-resonance is given approximately by equation (1), substituting the trace length for power plane dimension.
1. Bypass capacitors, since they have a self-inductance, resonate with each other. To achieve optimum transfer characteristics through 2 GHz, it is recommended that the bypass arrangement employed in the prototype board be used. The 30.1- Ω resistor in series with the 0.1- μF capacitor reduces the Q of the resonance of the lumped parallel elements including the 0.1- μF and 47-pF capacitors, and the power supply input of the amplifier. The ferrite bead isolates the low frequency 22- μF capacitor and

power plane from the remainder of the bypass network.

2. By removing the 30.1- Ω resistor and ferrite bead, the frequency response characteristic above 400 MHz may be modified. However, bandwidth, distortion, and transient response remain optimal.
3. Recommended values for power supply decoupling include a bulk decoupling capacitor (22 μF), a ferrite bead with a high self-resonant frequency, a mid-range decoupling capacitor (0.1 μF) in series with a 30.1- Ω resistor, and a high frequency decoupling capacitor (47 pF).

BOARD LAYOUT

Printed-Circuit Board Layout Techniques for Optimal Performance

Achieving optimum performance with a high frequency amplifier like the THS4303 requires careful attention to board layout parasitics and external component types.

Recommendations that optimize performance include:

1. **Minimize parasitic capacitance to any ac ground for all of the signal I/O pins.** However, if using a transmission line at the I/O, then place the matching resistor as close to the part as possible. Except for when transmission lines are used, parasitic capacitance on the output and the noninverting input pins can react with the load and source impedances to cause unintentional band limiting. To reduce unwanted capacitance, a window around the signal I/O pins should be opened in all of the ground and power planes around those pins. Otherwise, ground planes and power planes (if used) should be unbroken elsewhere on the board, and terminated as described in the Power Supply Decoupling section.
2. **Minimize the distance (< 0.25") from the power supply pins to high frequency 0.1- μF decoupling capacitors.** At the device pins, the ground and power plane layout should not be in close proximity to the signal I/O pins. Avoid narrow power and ground traces to minimize inductance between the pins and the decoupling capacitors. Note that each millimeter of a line, that is narrow relative to its length, has ~ 0.8 nH of inductance. The power supply connections should always be decoupled with the recommended capacitors. If not properly decoupled, distortion performance is degraded. Larger (6.8- μF to 22- μF) decoupling capacitors, effective at lower frequency, should also be used on the main supply lines, preferably decoupled from the amplifier and mid and high frequency capacitors by a ferrite bead. Reference the Power Supply Decoupling Techniques section. The larger caps may be placed somewhat farther from the device

and may be shared among several devices in the same area of the PC board. A very low inductance path should be used to connect the inverting pin of the amplifier to ground. A minimum of 5 vias as close to the part as possible is recommended.

3. **Careful selection and placement of external components preserves the high frequency performance of the THS4303.** Resistors should be a very low reactance type. Surface-mount resistors work best and allow a tighter overall layout. Axially-leaded parts do not provide good high frequency performance, since they have ~ 0.8 nH of inductance for every mm of current path length. Again, keep PC board trace length as short as possible. Never use wirewound type resistors in a high frequency application. Since the output pin and inverting input pin are the most sensitive to parasitic capacitance, always position the terminating resistors, if any, as close as possible to the noninverting and output pins. Even with a low parasitic capacitance shunting the external resistors, excessively high resistor values can create significant time constants that can degrade performance. Good axial metal-film or surface-mount resistors have approximately 0.2 pF in shunt with the resistor.
4. **Connections to other wideband devices on the board may be made with short direct traces or through onboard transmission lines.** For short connections, consider the trace and the input to the next device as a lumped capacitive load. Relatively wide traces (50 mils to 100 mils) should be used, preferably with ground and power planes opened up around them. Estimate the total capacitive load and set R_{ISO} from the plot of recommended R_{ISO} vs Capacitive Load. Low parasitic capacitive loads (<4 pF) may not need an R_{ISO} since the THS4303 is nominally compensated to operate with a 2 pF parasitic load. Higher parasitic capacitive loads without an R_{ISO} are allowed as the signal gain increases (increasing the unloaded phase margin). If a long trace is required, and the 6 dB signal loss intrinsic to a doubly-terminated transmission line is acceptable, implement a matched impedance transmission line using microstrip or stripline techniques (consult an ECL design handbook for microstrip and stripline layout techniques). With a characteristic board trace impedance defined based on board material and trace dimensions, a matching series resistor into the trace from the output of the THS4303 is used as well as a terminating shunt resistor at the input of the destination device. Remember also that the terminating impedance is the parallel combination of the shunt resistor and the input impedance of the

destination device: this total effective impedance should be set to match the trace impedance. If the 6 dB attenuation of a doubly terminated transmission line is unacceptable, a long trace can be series-terminated at the source end only. Treat the trace as a capacitive load in this case and set the series resistor value as shown in the plot of R_{ISO} vs Capacitive Load. This does not preserve signal integrity as well as a doubly-terminated line. If the input impedance of the destination device is low, there is some signal attenuation due to the voltage divider formed by the series output into the terminating impedance. A 50- Ω environment is normally not necessary on board as long as the lead lengths are short, and in fact, a higher impedance environment improves distortion as shown in the distortion versus load plots. Uncontrolled impedance traces without double termination results in reflections at each end, and hence, produces PCB resonances. It is recommended that if this approach is used, the trace length be kept short enough to avoid resonances in the band of interest. For guidance on useful lengths, use equation (1) given in the Power Supply Decoupling Techniques section for approximate resonance frequencies versus trace length. This relation provides an upper bound on the resonant frequency, because additional capacitive coupling to the trace from other leads or the ground plane causes extra distributed loading and slows the signal propagation along the trace.

5. **Socketing a high-speed part like the THS4303 is not recommended.** The additional lead length inductance and pin-to-pin capacitance introduced by the socket creates an extremely troublesome parasitic network, which can make it almost impossible to achieve a smooth, stable frequency response. Best results are obtained by soldering the THS4303 onto the board.

PowerPAD™ DESIGN CONSIDERATIONS

The THS4303 is available in a thermally-enhanced PowerPAD family of packages. These packages are constructed using a downset leadframe upon which the die is mounted [see Figure 48(a) and Figure 48(b)]. This arrangement results in the lead frame being exposed as a thermal pad on the underside of the package [see Figure 48(c)]. Because this thermal pad has direct thermal contact with the die, excellent thermal performance can be achieved by providing a good thermal path away from the thermal pad.

The PowerPAD package allows both assembly and thermal management in one manufacturing operation.

During the surface-mount solder operation (when the leads are being soldered), the thermal pad can also be soldered to a copper area underneath the package. Through the use of thermal paths within this copper area, heat can be conducted away from the package into either a ground plane or other heat dissipating device.

The PowerPAD package represents a breakthrough in combining the small area and ease of assembly of surface mount with the heretofore awkward mechanical methods of heatsinking.

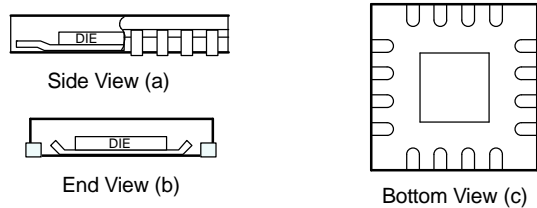

Figure 48. Views of Thermally Enhanced Package

Although there are many ways to properly heatsink the PowerPAD package, the following steps illustrate the recommended approach.

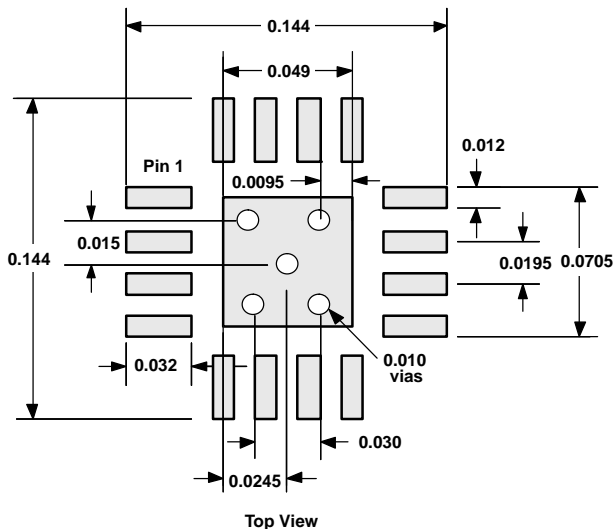

Figure 49. PowerPAD PCB Etch and Via Pattern

PowerPAD PCB LAYOUT CONSIDERATIONS

1. Prepare the PCB with a top side etch pattern as shown in Figure 49. There should be etch for the leads as well as etch for the thermal pad.
2. Place five holes in the area of the thermal pad. They holes should be 13 mils in diameter. Keep them small so that solder wicking through the holes is not a problem during reflow.
3. Additional vias may be placed anywhere along the thermal plane outside of the thermal pad

area. They help dissipate the heat generated by the IC. These additional vias may be larger than the 13-mil diameter vias directly under the thermal pad. They can be larger because they are not in the thermal pad area to be soldered, so that wicking is not a problem.

4. Connect all holes to the internal ground plane.
5. When connecting these holes to the ground plane, **do not** use the typical web or spoke via connection methodology. Web connections have a high thermal resistance connection that is useful for slowing the heat transfer during soldering operations. This resistance makes the soldering of vias that have plane connections easier. In this application, however, low thermal resistance is desired for the most efficient heat transfer. Therefore, the holes under the IC PowerPAD package should make their connection to the internal ground plane, with a complete connection around the entire circumference of the plated-through hole.
6. The top-side solder mask should leave the terminals of the package and the thermal pad area with its five holes exposed. The bottom-side solder mask should cover the five holes of the thermal pad area. This prevents solder from being pulled away from the thermal pad area during the reflow process.
7. Apply solder paste to the exposed thermal pad area and all of the IC terminals.
8. With these preparatory steps in place, the IC is simply placed in position and run through the solder reflow operation as any standard surface-mount component. This results in a part that is properly installed.

The next consideration is the package constraints. The two sources of heat within an amplifier are quiescent power and output power. The designer should never forget about the quiescent heat generated within the device, especially multi-amplifier devices. Because these devices have linear output stages (Class AB), most of the heat dissipation is at low output voltages with high output currents.

The other key factor when dealing with power dissipation is how the devices are mounted on the PCB. The PowerPAD devices are extremely useful for heat dissipation. But, the device should always be soldered to a copper plane to fully use the heat dissipation properties of the PowerPAD. The SOIC package, on the other hand, is highly dependent on how it is mounted on the PCB. As more trace and copper area is placed around the device, θ_{JA} decreases and the heat dissipation capability increases. For a single package, the sum of the RMS output currents and voltages should be used to choose the proper package.

THERMAL ANALYSIS

The THS4303 device does not incorporate automatic thermal shutoff protection, so the designer must take care to ensure that the design does not violate the absolute maximum junction temperature of the device. Failure may result if the absolute maximum junction temperature of 150° C is exceeded.

The thermal characteristics of the device are dictated by the package and the PC board. For a given θ_{JA} , maximum power dissipation for a package can be calculated using the following formula.

$$P_{Dmax} = \frac{T_{max} - T_A}{\theta_{JA}}$$

where:

P_{Dmax} is the maximum power dissipation in the amplifier (W).

T_{max} is the absolute maximum junction temperature (°C).

T_A is the ambient temperature (°C).

$$\theta_{JA} = \theta_{JC} + \theta_{CA}$$

θ_{JC} is the thermal coefficient from the silicon junctions to the case (°C/W).

θ_{CA} is the thermal coefficient from the case to ambient air (°C/W).

The THS4303 is offered in a 16-pin leadless MSOP with PowerPAD. The thermal coefficient for the MSOP PowerPAD package is substantially improved over the traditional packages. Maximum power dissipation levels are depicted in the graph below. The data for the RGT package assumes a board layout that follows the PowerPAD layout guidelines referenced above and detailed in the PowerPAD application notes in the *Additional Reference Material* section at the end of the data sheet.

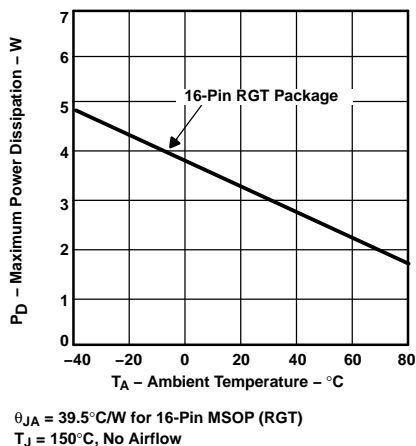

Figure 50. Maximum Power Dissipation vs Ambient Temperature

When determining whether or not the device satisfies the maximum power dissipation requirement, it is

important to consider not only quiescent power dissipation, but also dynamic power dissipation. Often maximum power is difficult to quantify because the signal pattern is inconsistent, but an estimate of the RMS power dissipation can provide visibility into a possible problem.

DESIGN TOOLS

Evaluation Fixtures and Application Support Information

Texas Instruments is committed to providing its customers with the highest quality of applications support. To support this goal, an evaluation board has been developed for the THS4303 operational amplifier. The evaluation board is available and easy to use allowing for straight-forward evaluation of the device. These evaluation board can be obtained by ordering through the Texas Instruments web site, www.ti.com, or through your local Texas Instruments Sales Representative. A schematic for the evaluation board is shown in Figure 51 with their default component values. Unpopulated footprints are shown to provide insight into design flexibility

Computer simulation of circuit performance using SPICE is often useful when analyzing the performance of analog circuits and systems. This is particularly true for video and RF amplifier circuits where parasitic capacitance and inductance can have a major effect on circuit performance. A SPICE model for the THS4303 device is available through the [Texas Instruments web site](http://www.ti.com) at www.ti.com. The Product Information Center (PIC) is also available for design assistance and detailed product information. These models do a good job of predicting small-signal ac and transient performance under a wide variety of operating conditions. They are not intended to model the distortion characteristics of the amplifier, nor do they attempt to distinguish between the package types in their small-signal ac performance. Detailed information about what is and is not modeled is contained in the model file itself.

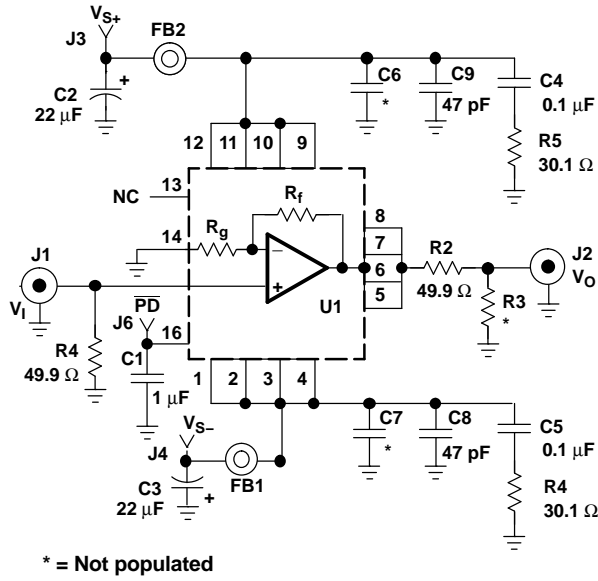

Figure 51. Typical THS4303 EVM Circuit Configuration

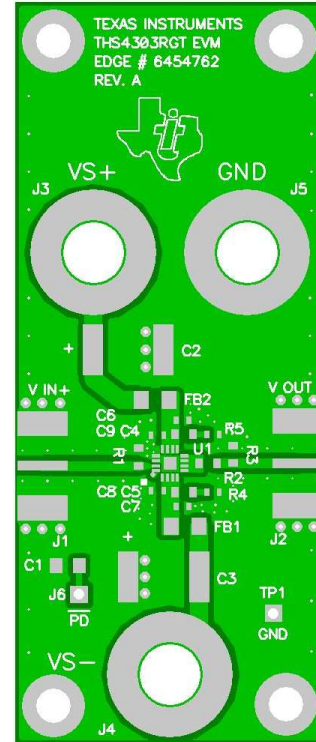

Figure 52. THS4303EVM Layout (Top Layer and Silkscreen Layer)

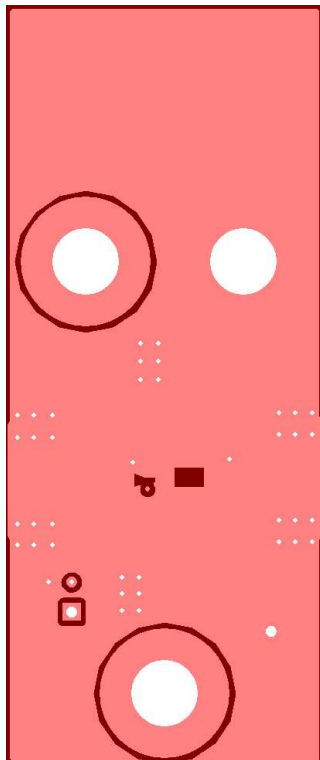

Figure 53. THS4303EVM Board Layout (Ground Layers 2 and 3)

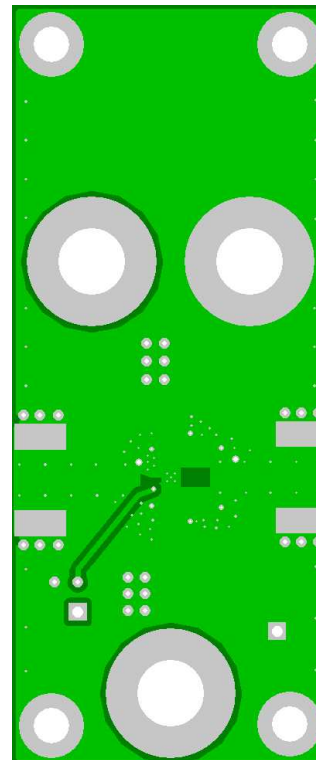

Figure 54. THS4303EVM Board Layout (Bottom Layer)

BILL OF MATERIALS**THS4303RGT EVM**

ITEM	DESCRIPTION	SMD SIZE	REFERENCE DESIGNATOR	PCB QUANTITY	MANUFACTURER'S PART NUMBER ⁽¹⁾
1	Bead, ferrite, 3 A, 80 Ω	1206	FB1, FB2	2	(Steward) HI1206N800R-00
2	Capacitor 22 μ F, tantalum, 25 V, 10%	D	C2, C3	2	(AVX) TAJD226K025R
3	Capacitor 1 μ F, ceramic, 25 V, Y5V	0805	C1	1	(AVX) 08053G105ZAT2A
4	Open	0402	C6, C7	2	
5	Capacitor 47 pF, ceramic, 50 V, NPO	0402	C8, C9	2	(AVX) 04025A470JAT2A
6	Capacitor 0.1 μ F, ceramic, 16 V, X7R	0603	C4, C5	2	(AVX) 0603YC104KAT2A
7	Resistor, 30.1 Ω , 1/16 W, 1%	0402	R4, R5	2	(KOA) RK73H1E30R1F
8	Open	0603	R3	1	
9	Resistor, 49.9 Ω , 1/16 W, 1%	0603	R1, R2	2	(Phycomp) 9C06031A49R9FKRFT
10	Jack, banana receptance, 0.25" dia. hole		J3, J4, J5	3	(HH Smith) 101
11	Test point, red		J6	1	(Keystone) 5000
12	Test point, black		TP1	1	(Keystone) 5001
13	Connector, edge, SMA PCB jack		J1, J2	2	(Johnson) 142-0701-801
14	IC THS4303		U1	1	(TI) THS4303RGT
15	Standoff, 4-40 hex, 0.625" length			4	(Keystone) 1808
16	Screw, phillips, 4-40, .250"			4	SHR-0440-016-SN
17	Board, printed-circuit			1	(TI) EDGE # 6454762 Rev. A

(1) The manufacturer's part numbers are used for test purposes only.

ADDITIONAL REFERENCE MATERIAL

- *PowerPAD Made Easy*, application brief (SLMA004)
- *PowerPAD Thermally Enhanced Package*, technical brief (SLMA002)

EVM WARNINGS AND RESTRICTIONS

It is important to operate this EVM within the input and output voltage ranges as specified in the table provided below.

Input Range, V_{S+} to V_{S-}	3.0 V to 6.0 V
Input Range, V_I	3.0 V to 6.0 V NOT TO EXCEED V_{S+} or V_{S-}
Output Range, V_O	3.0 V to 6.0 V NOT TO EXCEED V_{S+} or V_{S-}

Exceeding the specified input range may cause unexpected operation and/or irreversible damage to the EVM. If there are questions concerning the input range, please contact a TI field representative prior to connecting the input power.

Applying loads outside of the specified output range may result in unintended operation and/or possible permanent damage to the EVM. Please consult the product data sheet or EVM user's guide (if user's guide is available) prior to connecting any load to the EVM output. If there is uncertainty as to the load specification, please contact a TI field representative.

During normal operation, some circuit components may have case temperatures greater than 30°C. The EVM is designed to operate properly with certain components above 50°C as long as the input and output ranges are maintained. These components include but are not limited to linear regulators, switching transistors, pass transistors, and current sense resistors. These types of devices can be identified using the EVM schematic located in the material provided. When placing measurement probes near these devices during operation, please be aware that these devices may be very warm to the touch.

Mailing Address: Texas Instruments Post Office Box 655303 Dallas, Texas 75265

PACKAGING INFORMATION

Orderable Device	Status (1)	Package Type	Package Drawing	Pins	Package Qty	Eco Plan (2)	Lead finish/ Ball material (6)	MSL Peak Temp (3)	Op Temp (°C)	Device Marking (4/5)	Samples
THS4303RGTT	ACTIVE	VQFN	RGT	16	250	RoHS & Green	NIPDAU	Level-2-260C-1 YEAR	-40 to 85	4303	Samples
THS4303RGTTG4	ACTIVE	VQFN	RGT	16	250	RoHS & Green	NIPDAU	Level-2-260C-1 YEAR	-40 to 85	4303	Samples

(1) The marketing status values are defined as follows:

ACTIVE: Product device recommended for new designs.

LIFEBUY: TI has announced that the device will be discontinued, and a lifetime-buy period is in effect.

NRND: Not recommended for new designs. Device is in production to support existing customers, but TI does not recommend using this part in a new design.

PREVIEW: Device has been announced but is not in production. Samples may or may not be available.

OBSOLETE: TI has discontinued the production of the device.

(2) **RoHS:** TI defines "RoHS" to mean semiconductor products that are compliant with the current EU RoHS requirements for all 10 RoHS substances, including the requirement that RoHS substance do not exceed 0.1% by weight in homogeneous materials. Where designed to be soldered at high temperatures, "RoHS" products are suitable for use in specified lead-free processes. TI may reference these types of products as "Pb-Free".

RoHS Exempt: TI defines "RoHS Exempt" to mean products that contain lead but are compliant with EU RoHS pursuant to a specific EU RoHS exemption.

Green: TI defines "Green" to mean the content of Chlorine (Cl) and Bromine (Br) based flame retardants meet JS709B low halogen requirements of <=1000ppm threshold. Antimony trioxide based flame retardants must also meet the <=1000ppm threshold requirement.

(3) MSL, Peak Temp. - The Moisture Sensitivity Level rating according to the JEDEC industry standard classifications, and peak solder temperature.

(4) There may be additional marking, which relates to the logo, the lot trace code information, or the environmental category on the device.

(5) Multiple Device Markings will be inside parentheses. Only one Device Marking contained in parentheses and separated by a "~" will appear on a device. If a line is indented then it is a continuation of the previous line and the two combined represent the entire Device Marking for that device.

(6) Lead finish/Ball material - Orderable Devices may have multiple material finish options. Finish options are separated by a vertical ruled line. Lead finish/Ball material values may wrap to two lines if the finish value exceeds the maximum column width.

Important Information and Disclaimer:The information provided on this page represents TI's knowledge and belief as of the date that it is provided. TI bases its knowledge and belief on information provided by third parties, and makes no representation or warranty as to the accuracy of such information. Efforts are underway to better integrate information from third parties. TI has taken and continues to take reasonable steps to provide representative and accurate information but may not have conducted destructive testing or chemical analysis on incoming materials and chemicals. TI and TI suppliers consider certain information to be proprietary, and thus CAS numbers and other limited information may not be available for release.

In no event shall TI's liability arising out of such information exceed the total purchase price of the TI part(s) at issue in this document sold by TI to Customer on an annual basis.

RGT 16

GENERIC PACKAGE VIEW

VQFN - 1 mm max height

PLASTIC QUAD FLATPACK - NO LEAD



Images above are just a representation of the package family, actual package may vary.
Refer to the product data sheet for package details.

4203495/1

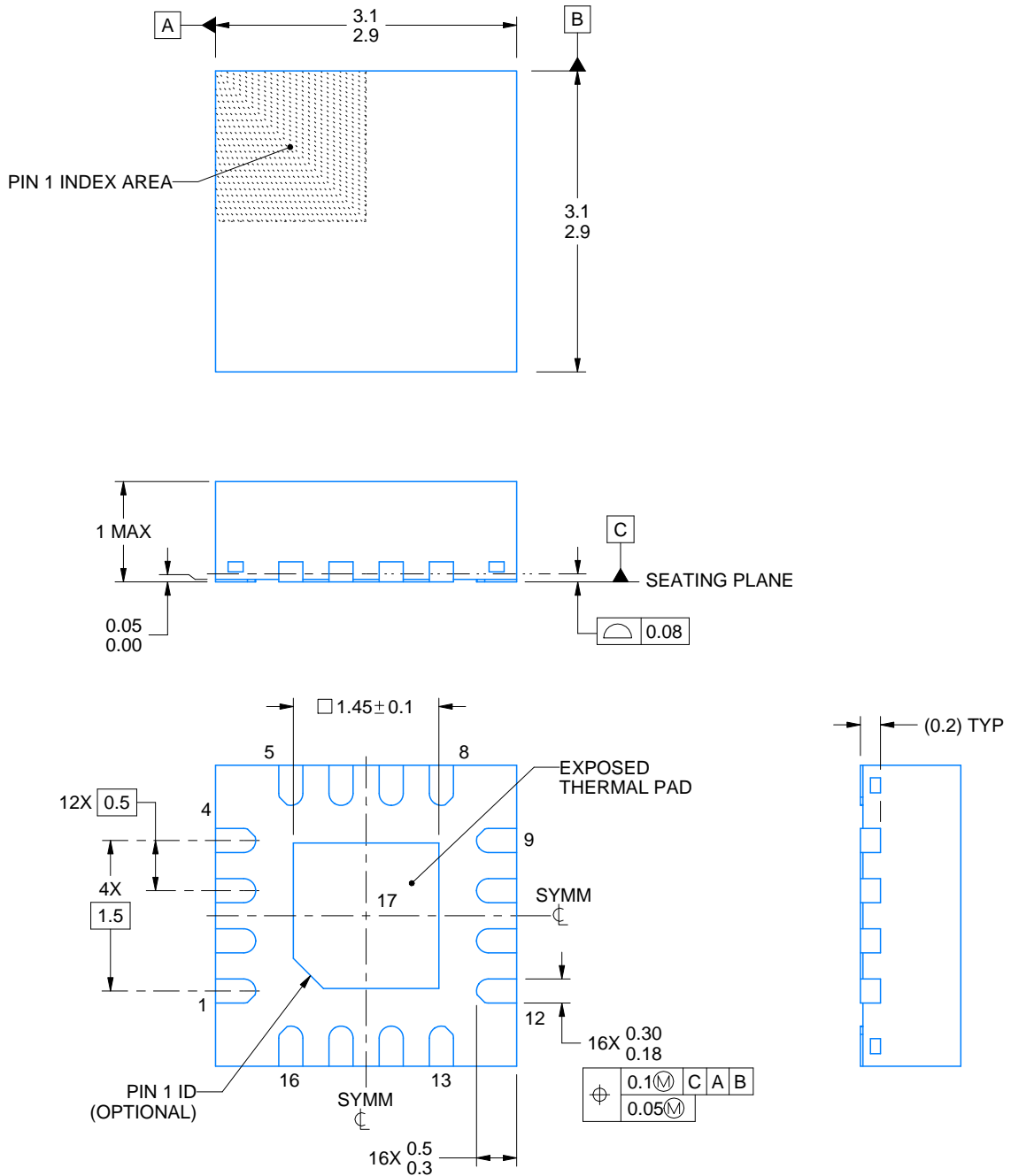
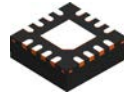

4219032/A 02/2017

NOTES:

1. All linear dimensions are in millimeters. Any dimensions in parenthesis are for reference only. Dimensioning and tolerancing per ASME Y14.5M.
2. This drawing is subject to change without notice.
3. The package thermal pad must be soldered to the printed circuit board for thermal and mechanical performance.
4. Reference JEDEC registration MO-220

EXAMPLE STENCIL DESIGN

RGT0016A

VQFN - 1 mm max height

PLASTIC QUAD FLATPACK - NO LEAD

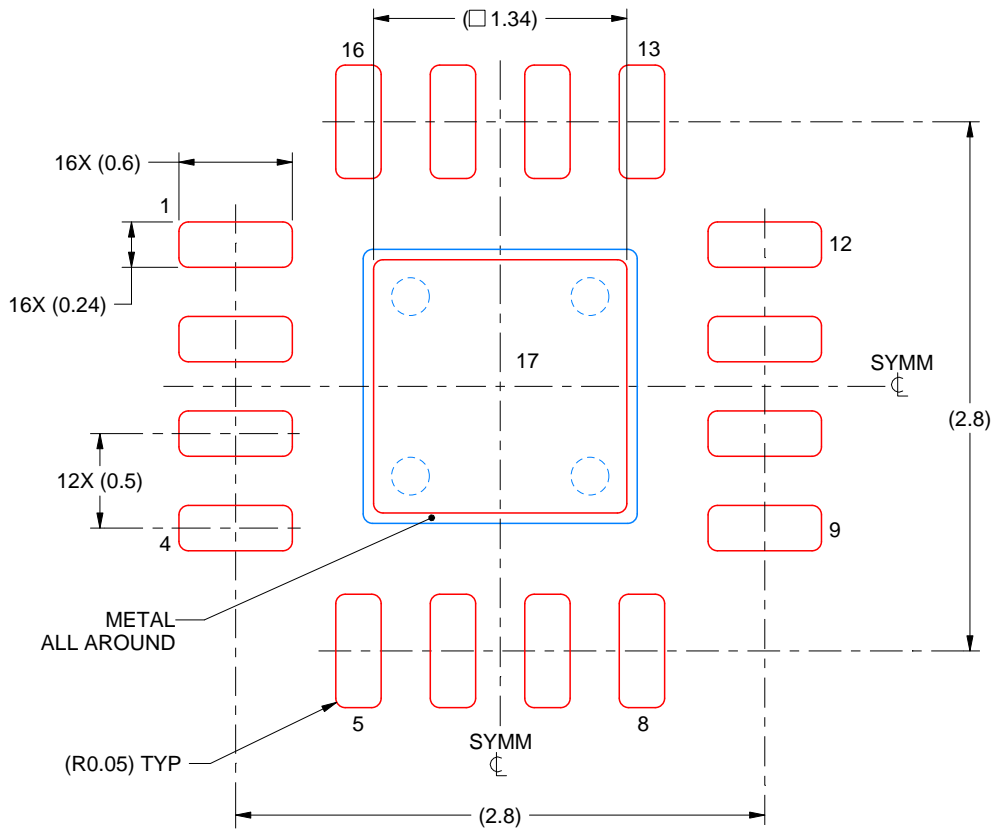

SOLDER PASTE EXAMPLE
BASED ON 0.125 mm THICK STENCIL

EXPOSED PAD 17:
86% PRINTED SOLDER COVERAGE BY AREA UNDER PACKAGE
SCALE:25X

4219032/A 02/2017

NOTES: (continued)

7. Laser cutting apertures with trapezoidal walls and rounded corners may offer better paste release. IPC-7525 may have alternate design recommendations.

IMPORTANT NOTICE AND DISCLAIMER

TI PROVIDES TECHNICAL AND RELIABILITY DATA (INCLUDING DATASHEETS), DESIGN RESOURCES (INCLUDING REFERENCE DESIGNS), APPLICATION OR OTHER DESIGN ADVICE, WEB TOOLS, SAFETY INFORMATION, AND OTHER RESOURCES "AS IS" AND WITH ALL FAULTS, AND DISCLAIMS ALL WARRANTIES, EXPRESS AND IMPLIED, INCLUDING WITHOUT LIMITATION ANY IMPLIED WARRANTIES OF MERCHANTABILITY, FITNESS FOR A PARTICULAR PURPOSE OR NON-INFRINGEMENT OF THIRD PARTY INTELLECTUAL PROPERTY RIGHTS.

These resources are intended for skilled developers designing with TI products. You are solely responsible for (1) selecting the appropriate TI products for your application, (2) designing, validating and testing your application, and (3) ensuring your application meets applicable standards, and any other safety, security, or other requirements. These resources are subject to change without notice. TI grants you permission to use these resources only for development of an application that uses the TI products described in the resource. Other reproduction and display of these resources is prohibited. No license is granted to any other TI intellectual property right or to any third party intellectual property right. TI disclaims responsibility for, and you will fully indemnify TI and its representatives against, any claims, damages, costs, losses, and liabilities arising out of your use of these resources.

TI's products are provided subject to TI's Terms of Sale (<https://www.ti.com/legal/termsofsale.html>) or other applicable terms available either on [ti.com](https://www.ti.com) or provided in conjunction with such TI products. TI's provision of these resources does not expand or otherwise alter TI's applicable warranties or warranty disclaimers for TI products.

Mailing Address: Texas Instruments, Post Office Box 655303, Dallas, Texas 75265
Copyright © 2021, Texas Instruments Incorporated