

# NTMSD3P303R2

## FETKY™

### P-Channel Enhancement-Mode Power MOSFET and Schottky Diode Dual SO-8 Package

#### Features

- High Efficiency Components in a Single SO-8 Package
- High Density Power MOSFET with Low  $R_{DS(on)}$ , Schottky Diode with Low  $V_F$
- Independent Pin-Outs for MOSFET and Schottky Die Allowing for Flexibility in Application Use
- Less Component Placement for Board Space Savings
- SO-8 Surface Mount Package, Mounting Information for SO-8 Package Provided
- Pb-Free Package is Available

#### Applications

- DC-DC Converters
- Low Voltage Motor Control
- Power Management in Portable and Battery-Powered Products, i.e.: Computers, Printers, PCMCIA Cards, Cellular and Cordless Telephones

#### MOSFET MAXIMUM RATINGS ( $T_J = 25^\circ\text{C}$ unless otherwise noted)

Rating	Symbol	Value	Unit
Drain-to-Source Voltage	$V_{DSS}$	-30	V
Gate-to-Source Voltage - Continuous	$V_{GS}$	$\pm 20$	V
Thermal Resistance - Junction-to-Ambient (Note 1)	$R_{\theta JA}$	171	$^\circ\text{C}/\text{W}$
Total Power Dissipation @ $T_A = 25^\circ\text{C}$	$P_D$	0.73	W
Continuous Drain Current @ $T_A = 25^\circ\text{C}$	$I_D$	-2.34	A
Continuous Drain Current @ $T_A = 70^\circ\text{C}$	$I_D$	-1.87	A
Pulsed Drain Current (Note 4)	$I_{DM}$	-8.0	A
Thermal Resistance - Junction-to-Ambient (Note 2)	$R_{\theta JA}$	100	$^\circ\text{C}/\text{W}$
Total Power Dissipation @ $T_A = 25^\circ\text{C}$	$P_D$	1.25	W
Continuous Drain Current @ $T_A = 25^\circ\text{C}$	$I_D$	-3.05	A
Continuous Drain Current @ $T_A = 70^\circ\text{C}$	$I_D$	-2.44	A
Pulsed Drain Current (Note 4)	$I_{DM}$	-12	A
Thermal Resistance - Junction-to-Ambient (Note 3)	$R_{\theta JA}$	62.5	$^\circ\text{C}/\text{W}$
Total Power Dissipation @ $T_A = 25^\circ\text{C}$	$P_D$	2.0	W
Continuous Drain Current @ $T_A = 25^\circ\text{C}$	$I_D$	-3.86	A
Continuous Drain Current @ $T_A = 70^\circ\text{C}$	$I_D$	-3.10	A
Pulsed Drain Current (Note 4)	$I_{DM}$	-15	A
Operating and Storage Temperature Range	$T_J, T_{stg}$	-55 to +150	$^\circ\text{C}$
Single Pulse Drain-to-Source Avalanche Energy - Starting $T_J = 25^\circ\text{C}$ ( $V_{DD} = -30$ Vdc, $V_{GS} = -4.5$ Vdc, Peak $I_L = -7.5$ Apk, $L = 5$ mH, $R_G = 25 \Omega$ )	$E_{AS}$	140	mJ
Maximum Lead Temperature for Soldering Purposes, 1/8" from case for 10 seconds	$T_L$	260	$^\circ\text{C}$

Stresses exceeding Maximum Ratings may damage the device. Maximum Ratings are stress ratings only. Functional operation above the Recommended Operating Conditions is not implied. Extended exposure to stresses above the Recommended Operating Conditions may affect device reliability.

1. Minimum FR-4 or G-10 PCB, Steady State.
2. Mounted onto a 2" square FR-4 Board (1 in sq, 2 oz Cu 0.06" thick single sided), Steady State.
3. Mounted onto a 2" square FR-4 Board (1 in sq, 2 oz Cu 0.06" thick single sided),  $t \leq 10$  seconds.
4. Pulse Test: Pulse Width = 300  $\mu\text{s}$ , Duty Cycle = 2%.

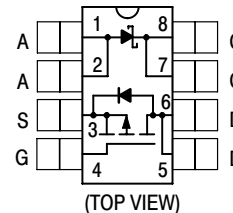


ON Semiconductor®

<http://onsemi.com>

**MOSFET**  
**-3.05 AMPERES**  
**-30 VOLTS**  
**0.085  $\Omega$  @  $V_{GS} = -10$  V**

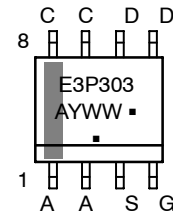
**SCHOTTKY DIODE**  
**3.0 AMPERES**  
**30 VOLTS**  
**420 mV @  $I_F = 3.0$  A**



#### MARKING DIAGRAM & PIN ASSIGNMENT



SO-8  
CASE 751  
STYLE 18



E3P303 = Device Code  
A = Assembly Location  
Y = Year  
WW = Work Week  
▪ = Pb-Free Package

(Note: Microdot may be in either location)

#### ORDERING INFORMATION

Device	Package	Shipping†
NTMSD3P303R2	SO-8	2500/Tape & Reel
NTMSD3P303R2G	SO-8 (Pb-Free)	2500/Tape & Reel

†For information on tape and reel specifications, including part orientation and tape sizes, please refer to our Tape and Reel Packaging Specification Brochure, BRD8011/D.

# NTMSD3P303R2

## SCHOTTKY MAXIMUM RATINGS ( $T_J = 25^\circ\text{C}$ unless otherwise noted)

Rating	Symbol	Value	Unit
Peak Repetitive Reverse Voltage DC Blocking Voltage	$V_{RRM}$ $V_R$	30	V
Thermal Resistance – Junction-to-Ambient (Note 5)	$R_{\theta JA}$	197	$^\circ\text{C/W}$
Thermal Resistance – Junction-to-Ambient (Note 6)	$R_{\theta JA}$	97	$^\circ\text{C/W}$
Thermal Resistance – Junction-to-Ambient (Note 7)	$R_{\theta JA}$	62.5	$^\circ\text{C/W}$
Average Forward Current (Note 7) (Rated $V_R$ , $T_A = 100^\circ\text{C}$ )	$I_O$	3.0	A
Peak Repetitive Forward Current (Note 7) (Rated $V_R$ , Square Wave, 20 kHz, $T_A = 105^\circ\text{C}$ )	$I_{FRM}$	6.0	A
Non-Repetitive Peak Surge Current (Note 7) (Surge Applied at Rated Load Conditions, Half-Wave, Single Phase, 60 Hz)	$I_{FSM}$	30	A

Stresses exceeding Maximum Ratings may damage the device. Maximum Ratings are stress ratings only. Functional operation above the Recommended Operating Conditions is not implied. Extended exposure to stresses above the Recommended Operating Conditions may affect device reliability.

5. Minimum FR-4 or G-10 PCB, Steady State.
6. Mounted onto a 2" square FR-4 Board (1 in sq, 2 oz Cu 0.06" thick single sided), Steady State.
7. Mounted onto a 2" square FR-4 Board (1 in sq, 2 oz Cu 0.06" thick single sided),  $t \leq 10$  seconds.

## ELECTRICAL CHARACTERISTICS ( $T_J = 25^\circ\text{C}$ unless otherwise noted) (Note 8)

Characteristic	Symbol	Min	Typ	Max	Unit
----------------	--------	-----	-----	-----	------

### OFF CHARACTERISTICS

Drain-to-Source Breakdown Voltage ( $V_{GS} = 0$ Vdc, $I_D = -250$ $\mu\text{Adc}$ ) Temperature Coefficient (Positive)	$V_{(BR)DSS}$	-30 -	- -30	- -	Vdc $\text{mV}/^\circ\text{C}$
Zero Gate Voltage Drain Current ( $V_{DS} = -30$ Vdc, $V_{GS} = 0$ Vdc, $T_J = 25^\circ\text{C}$ ) ( $V_{DS} = -30$ Vdc, $V_{GS} = 0$ Vdc, $T_J = 125^\circ\text{C}$ )	$I_{DSS}$	- -	- -	-1.0 -25	$\mu\text{Adc}$
Gate-Body Leakage Current ( $V_{GS} = -20$ Vdc, $V_{DS} = 0$ Vdc)	$I_{GSS}$	-	-	-100	nAdc
Gate-Body Leakage Current ( $V_{GS} = +20$ Vdc, $V_{DS} = 0$ Vdc)	$I_{GSS}$	-	-	100	nAdc

### ON CHARACTERISTICS

Gate Threshold Voltage ( $V_{DS} = V_{GS}$ , $I_D = -250$ $\mu\text{Adc}$ ) Temperature Coefficient (Negative)	$V_{GS(th)}$	-1.0 -	-1.7 3.6	-2.5 -	Vdc
Static Drain-to-Source On-State Resistance ( $V_{GS} = -10$ Vdc, $I_D = -3.05$ Adc) ( $V_{GS} = -4.5$ Vdc, $I_D = -1.5$ Adc)	$R_{DS(on)}$	- -	0.063 0.090	0.085 0.125	$\Omega$
Forward Transconductance ( $V_{DS} = -15$ Vdc, $I_D = -3.05$ Adc)	$g_{FS}$	-	5.0	-	Mhos

### DYNAMIC CHARACTERISTICS

Input Capacitance	$(V_{DS} = -24$ Vdc, $V_{GS} = 0$ Vdc, $f = 1.0$ MHz)	$C_{ISS}$	-	520	750	pF
Output Capacitance		$C_{OSS}$	-	170	325	
Reverse Transfer Capacitance		$C_{RSS}$	-	70	135	

8. Handling precautions to protect against electrostatic discharge are mandatory.

# NTMSD3P303R2

## MOSFET ELECTRICAL CHARACTERISTICS ( $T_J = 25^\circ\text{C}$ unless otherwise noted) (Note 9)

Characteristic	Symbol	Min	Typ	Max	Unit	
<b>SWITCHING CHARACTERISTICS</b> (Notes 10 & 11)						
Turn-On Delay Time	$(V_{DD} = -24\text{ Vdc},$ $I_D = -3.05\text{ Adc},$ $V_{GS} = -10\text{ Vdc},$ $R_G = 6.0\ \Omega)$	$t_{d(on)}$	-	12	22	ns
Rise Time		$t_r$	-	16	30	
Turn-Off Delay Time		$t_{d(off)}$	-	45	80	
Fall Time		$t_f$	-	45	80	
Turn-On Delay Time	$(V_{DD} = -24\text{ Vdc},$ $I_D = -1.5\text{ Adc},$ $V_{GS} = -4.5\text{ Vdc},$ $R_G = 6.0\ \Omega)$	$t_{d(on)}$	-	16	-	ns
Rise Time		$t_r$	-	42	-	
Turn-Off Delay Time		$t_{d(off)}$	-	32	-	
Fall Time		$t_f$	-	35	-	
Total Gate Charge	$(V_{DS} = -24\text{ Vdc},$ $V_{GS} = -10\text{ Vdc},$ $I_D = -3.05\text{ Adc})$	$Q_{tot}$	-	16	25	nC
Gate-Source Charge		$Q_{gs}$	-	2.0	-	
Gate-Drain Charge		$Q_{gd}$	-	4.5	-	

## BODY-DRAIN DIODE RATINGS (Note 10)

Diode Forward On-Voltage	$(I_S = -3.05\text{ Adc}, V_{GS} = 0\text{ Vdc})$ $(I_S = -3.05\text{ Adc}, V_{GS} = 0\text{ Vdc}, T_J = 125^\circ\text{C})$	$V_{SD}$	-	-0.96 -0.78	-1.25 -	Vdc
Reverse Recovery Time	$(I_S = -3.05\text{ Adc},$ $V_{GS} = 0\text{ Vdc},$ $dI_S/dt = 100\text{ A}/\mu\text{s})$	$t_{rr}$	-	34	-	ns
		$t_a$	-	18	-	
		$t_b$	-	16	-	
Reverse Recovery Stored Charge		$Q_{RR}$	-	0.03	-	$\mu\text{C}$

9. Handling precautions to protect against electrostatic discharge is mandatory.

10. Indicates Pulse Test: Pulse Width = 300  $\mu\text{s}$  max, Duty Cycle = 2%.

11. Switching characteristics are independent of operating junction temperature.

## SCHOTTKY RECTIFIER ELECTRICAL CHARACTERISTICS ( $T_J = 25^\circ\text{C}$ unless otherwise noted) (Note 12)

Maximum Instantaneous Forward Voltage	$I_F = 100\text{ mAdc}$ $I_F = 3.0\text{ Adc}$ $I_F = 6.0\text{ Adc}$	$V_F$	$T_J = 25^\circ\text{C}$	$T_J = 125^\circ\text{C}$	Volts
			0.28	0.13	Volts
			0.42	0.33	
			0.50	0.45	
Maximum Instantaneous Reverse Current	$V_R = 30\text{ Vdc}$	$I_R$	$T_J = 25^\circ\text{C}$	$T_J = 125^\circ\text{C}$	$\mu\text{A}$ mA
			250	25	
Maximum Voltage Rate of Change	$V_R = 30\text{ Vdc}$	$dV/dt$	10,000		$\text{V}/\mu\text{s}$

12. Indicates Pulse Test: Pulse Width = 300  $\mu\text{s}$  max, Duty Cycle = 2%.

TYPICAL MOSFET ELECTRICAL CHARACTERISTICS

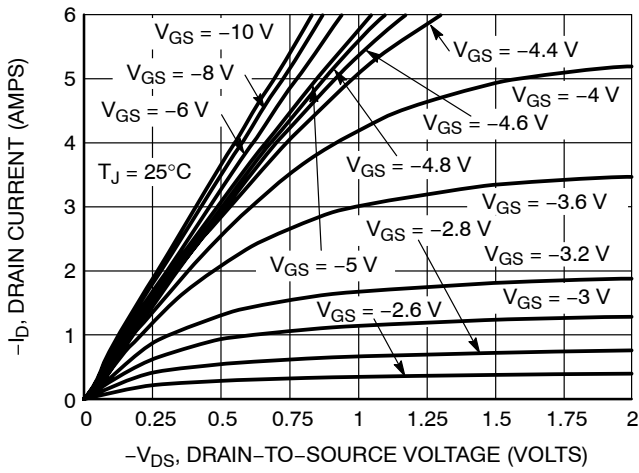


Figure 1. On-Region Characteristics

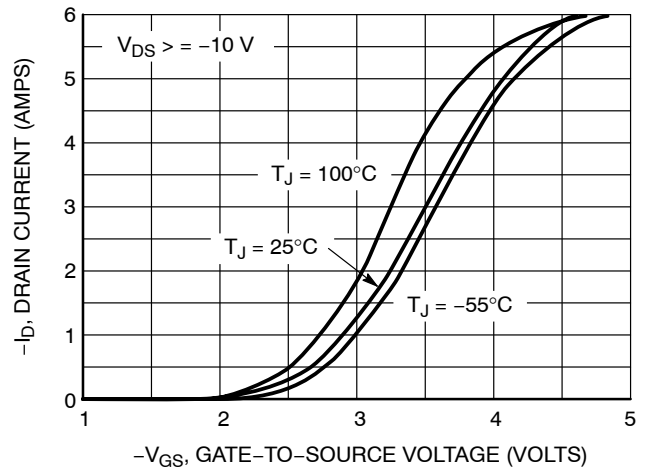


Figure 2. Transfer Characteristics

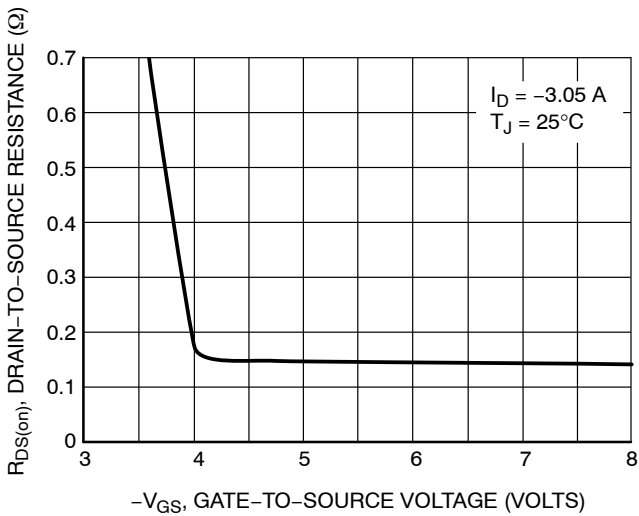


Figure 3. On-Resistance vs. Gate-to-Source Voltage

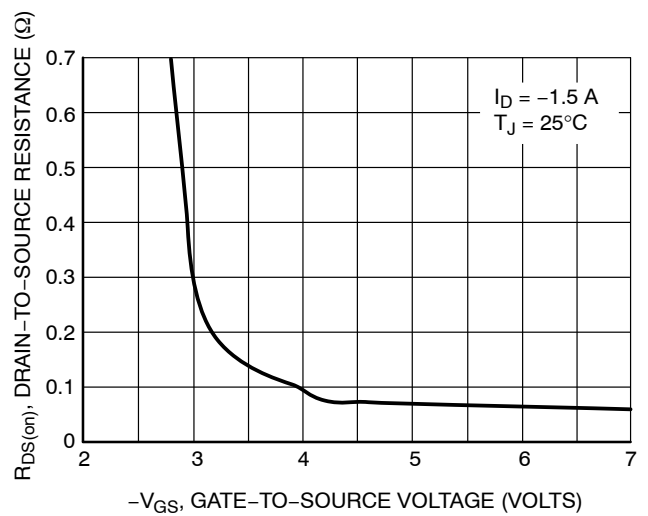


Figure 4. On-Resistance vs. Gate-to-Source Voltage

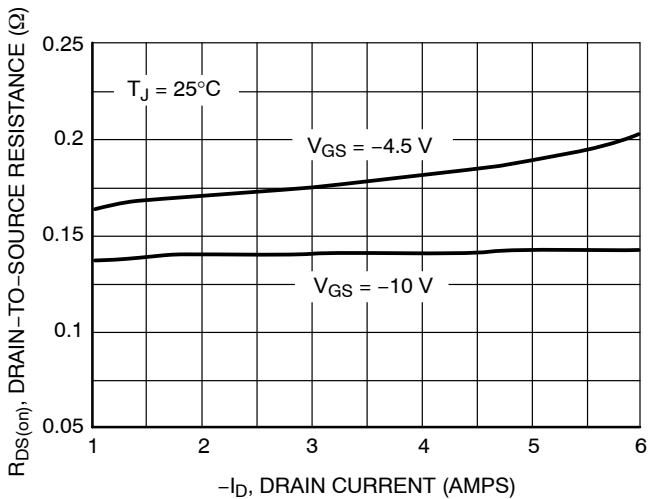


Figure 5. On-Resistance vs. Drain Current and Gate Voltage

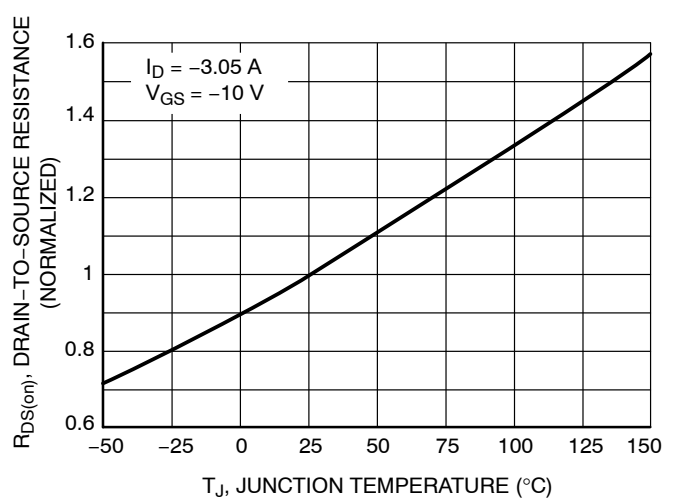
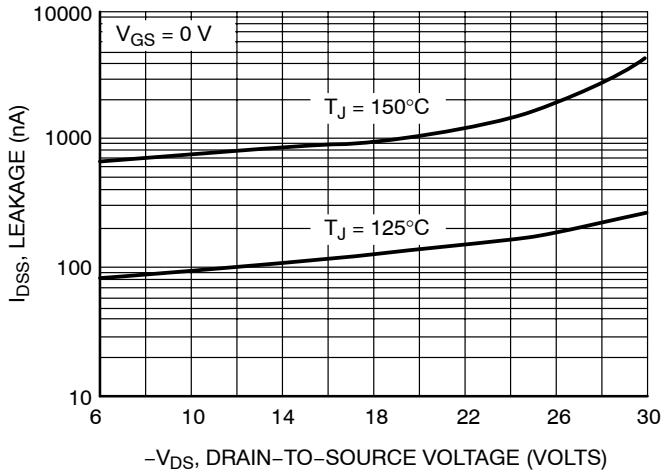
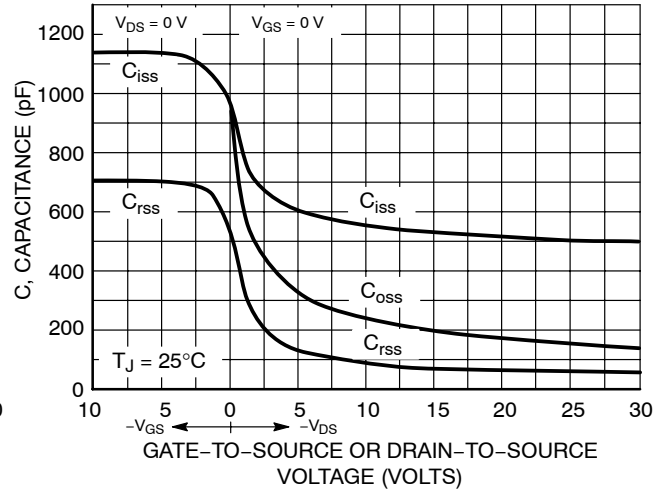


Figure 6. On Resistance Variation with Temperature

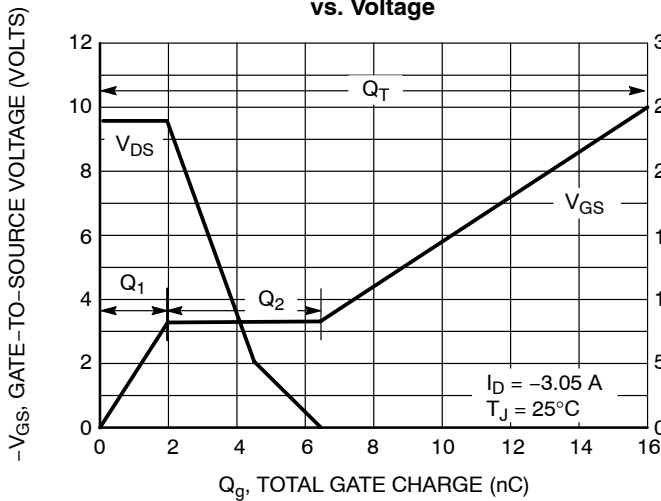
# NTMSD3P303R2



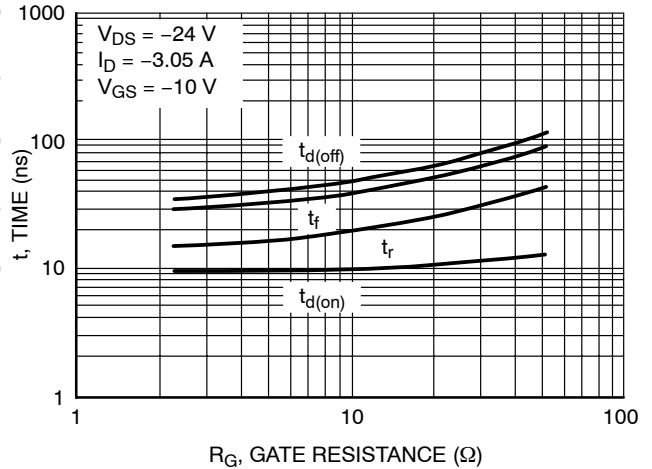
**Figure 7. Drain-to-Source Leakage Current vs. Voltage**



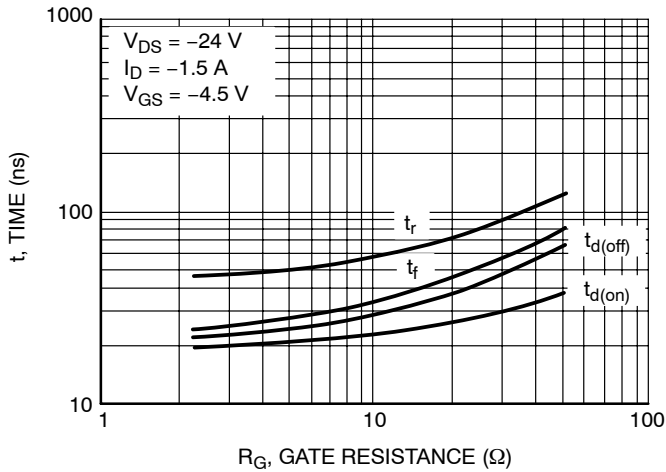
**Figure 8. Capacitance Variation**



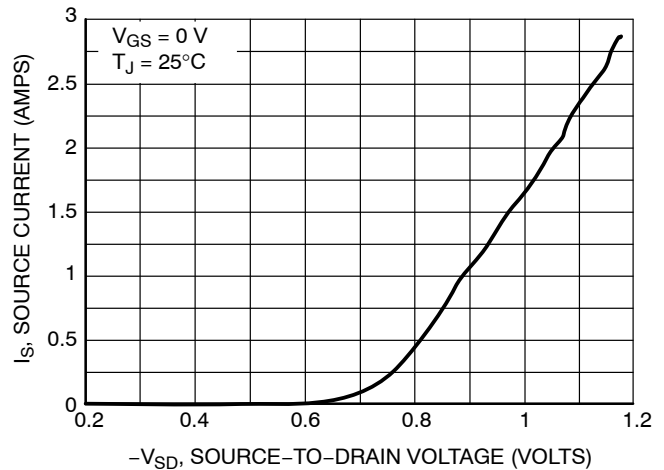
**Figure 9. Gate-to-Source and Drain-to-Source Voltage vs. Total Charge**



**Figure 10. Resistive Switching Time Variation vs. Gate Resistance**

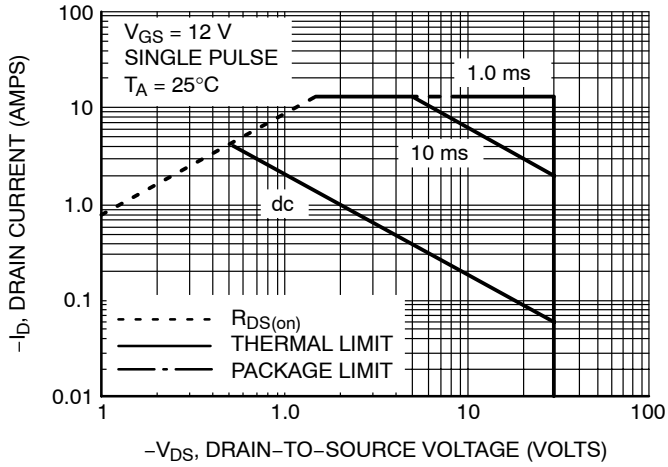


**Figure 11. Resistive Switching Time Variation vs. Gate Resistance**

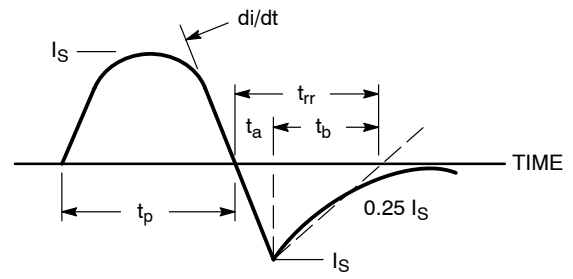


**Figure 12. Diode Forward Voltage vs. Current**

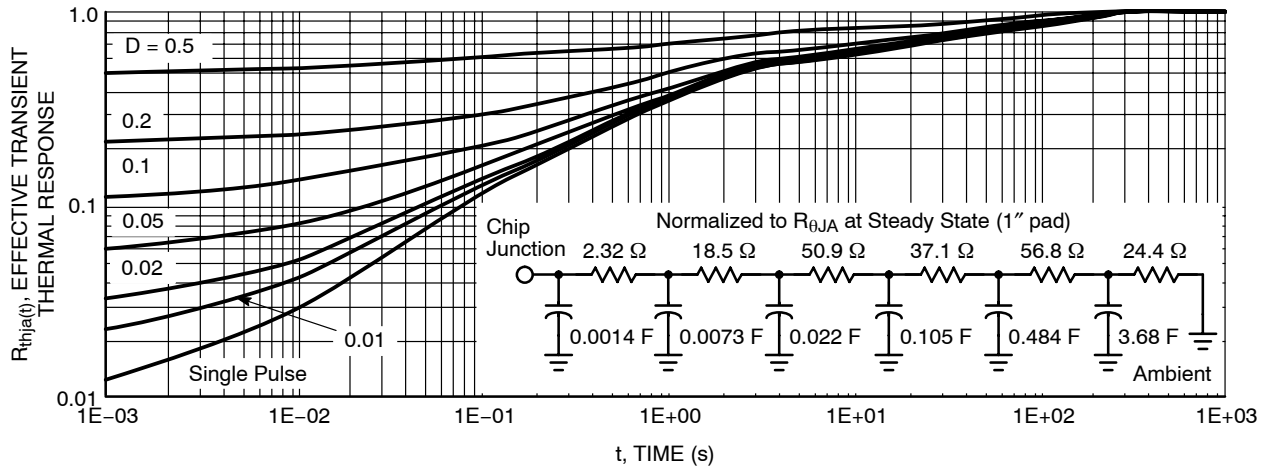
# NTMSD3P303R2



**Figure 13. Maximum Rated Forward Biased Safe Operating Area**



**Figure 14. Diode Reverse Recovery Waveform**



**Figure 15. FET Thermal Response**

TYPICAL SCHOTTKY ELECTRICAL CHARACTERISTICS

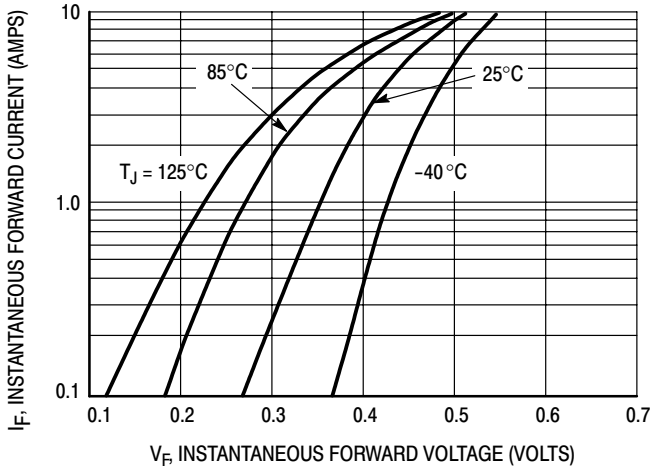


Figure 16. Typical Forward Voltage

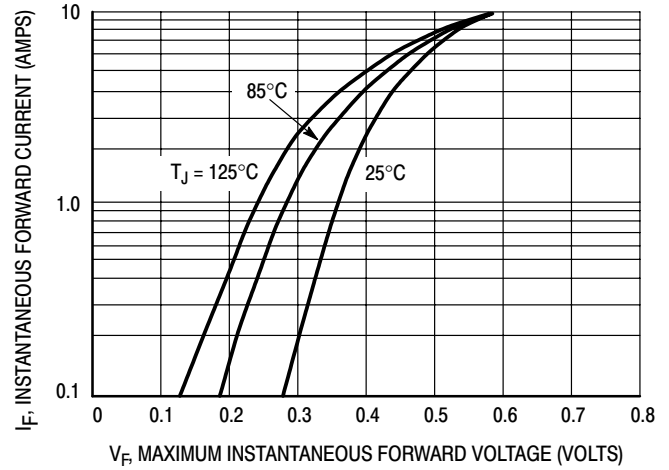


Figure 17. Maximum Forward Voltage

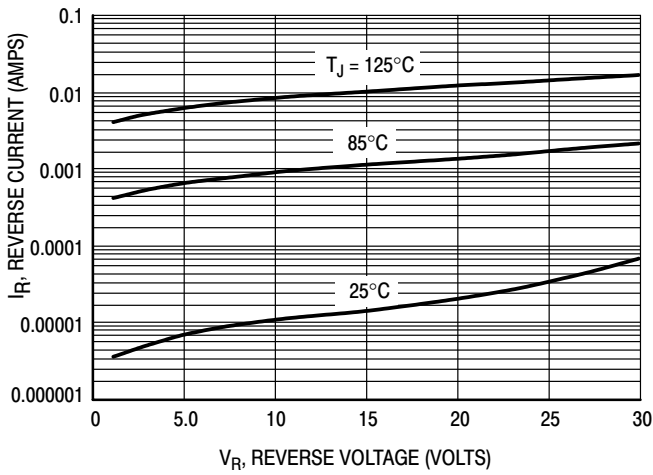


Figure 18. Typical Reverse Current

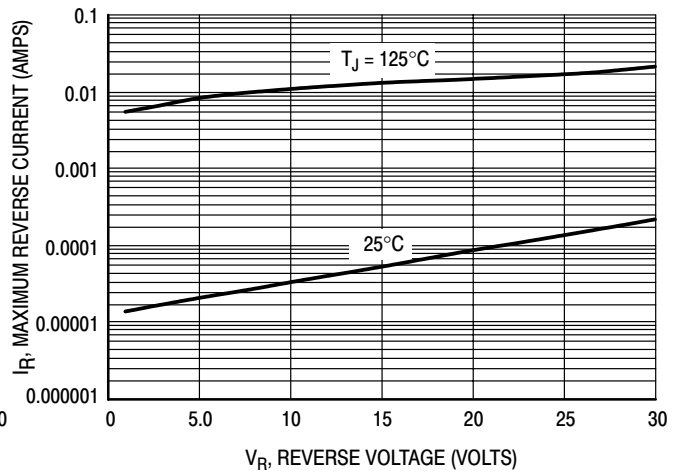


Figure 19. Maximum Reverse Current

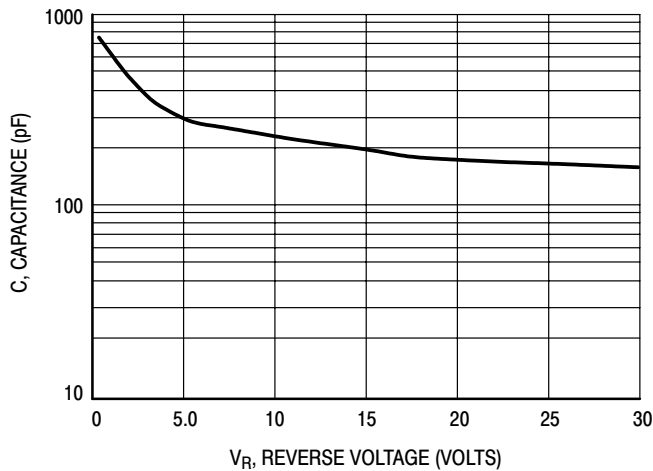


Figure 20. Typical Capacitance

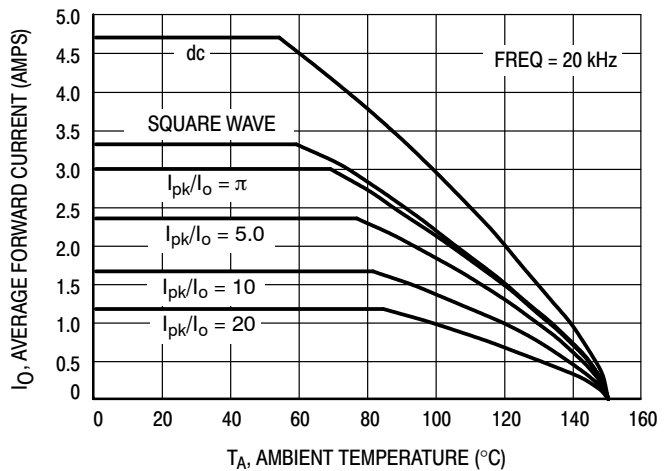


Figure 21. Current Derating

# NTMSD3P303R2

## TYPICAL SCHOTTKY ELECTRICAL CHARACTERISTICS

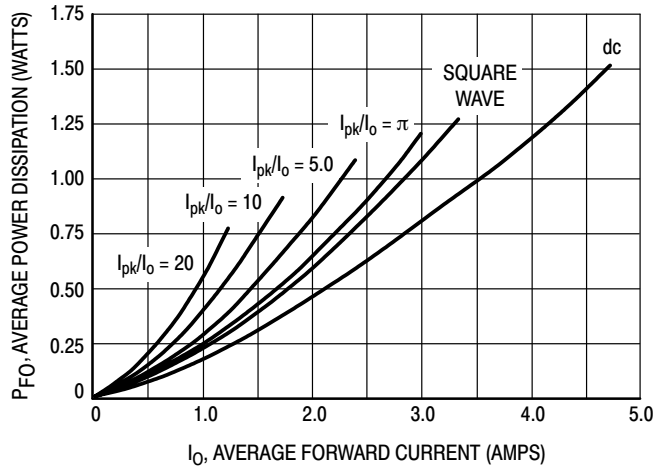


Figure 22. Forward Power Dissipation

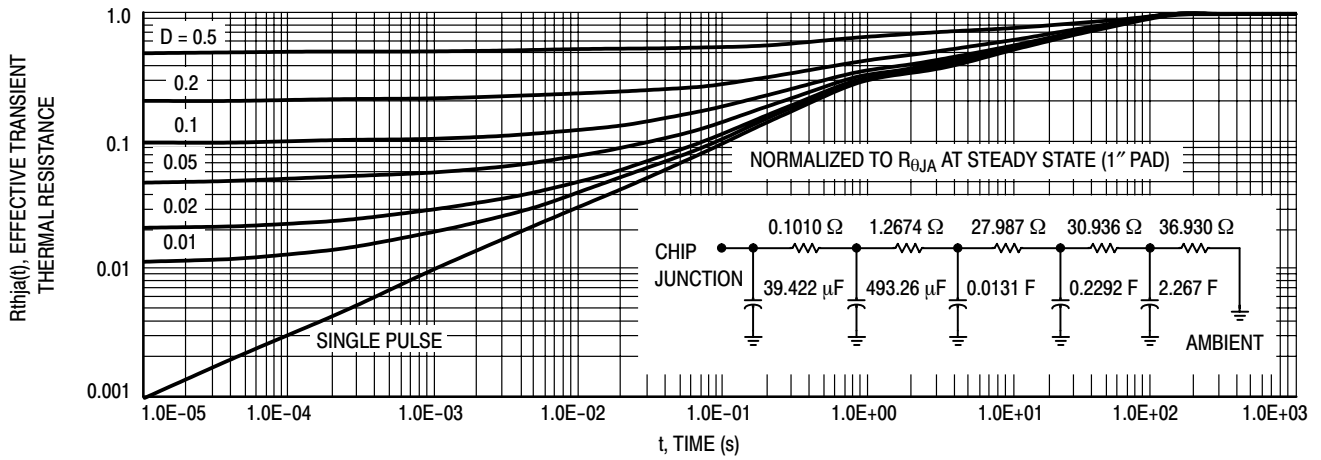


Figure 23. Schottky Thermal Response



# MECHANICAL CASE OUTLINE PACKAGE DIMENSIONS

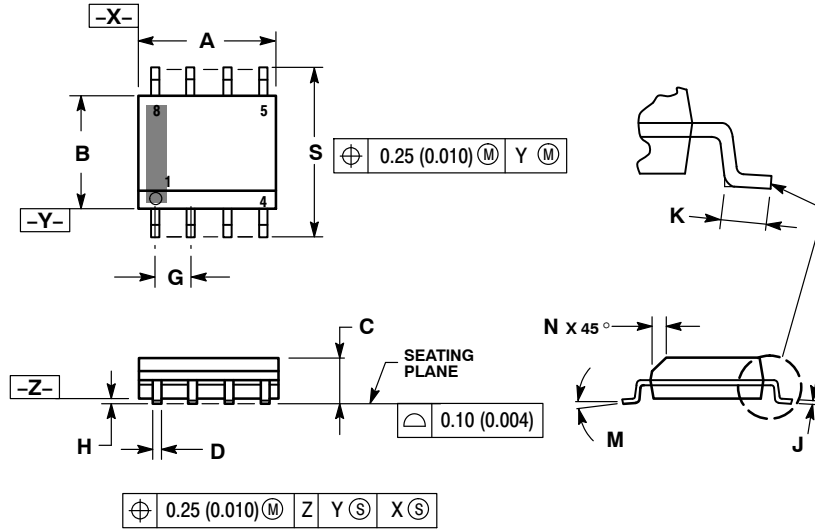
ON Semiconductor®



SCALE 1:1

SOIC-8 NB  
CASE 751-07  
ISSUE AK

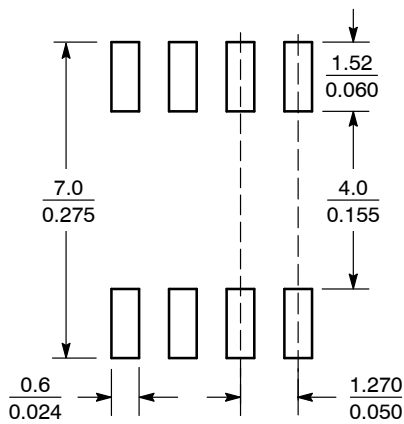
DATE 16 FEB 2011



- NOTES:
1. DIMENSIONING AND TOLERANCING PER ANSI Y14.5M, 1982.
  2. CONTROLLING DIMENSION: MILLIMETER.
  3. DIMENSION A AND B DO NOT INCLUDE MOLD PROTRUSION.
  4. MAXIMUM MOLD PROTRUSION 0.15 (0.006) PER SIDE.
  5. DIMENSION D DOES NOT INCLUDE DAMBAR PROTRUSION. ALLOWABLE DAMBAR PROTRUSION SHALL BE 0.127 (0.005) TOTAL IN EXCESS OF THE D DIMENSION AT MAXIMUM MATERIAL CONDITION.
  6. 751-01 THRU 751-06 ARE OBSOLETE. NEW STANDARD IS 751-07.

DIM	MILLIMETERS		INCHES	
	MIN	MAX	MIN	MAX
A	4.80	5.00	0.189	0.197
B	3.80	4.00	0.150	0.157
C	1.35	1.75	0.053	0.069
D	0.33	0.51	0.013	0.020
G	1.27 BSC		0.050 BSC	
H	0.10	0.25	0.004	0.010
J	0.19	0.25	0.007	0.010
K	0.40	1.27	0.016	0.050
M	0°	8°	0°	8°
N	0.25	0.50	0.010	0.020
S	5.80	6.20	0.228	0.244

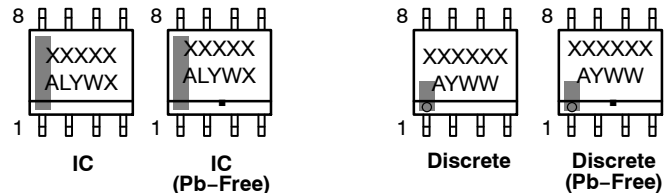
### SOLDERING FOOTPRINT\*



SCALE 6:1 (mm/inches)

\*For additional information on our Pb-Free strategy and soldering details, please download the ON Semiconductor Soldering and Mounting Techniques Reference Manual, SOLDERRM/D.

### GENERIC MARKING DIAGRAM\*



XXXXXX = Specific Device Code  
A = Assembly Location  
L = Wafer Lot  
Y = Year  
W = Work Week  
▪ = Pb-Free Package

XXXXXX = Specific Device Code  
A = Assembly Location  
Y = Year  
WW = Work Week  
▪ = Pb-Free Package

\*This information is generic. Please refer to device data sheet for actual part marking. Pb-Free indicator, "G" or microdot "▪", may or may not be present. Some products may not follow the Generic Marking.

STYLES ON PAGE 2

DOCUMENT NUMBER:	98ASB42564B	Electronic versions are uncontrolled except when accessed directly from the Document Repository. Printed versions are uncontrolled except when stamped "CONTROLLED COPY" in red.
DESCRIPTION:	SOIC-8 NB	PAGE 1 OF 2

ON Semiconductor and ON are trademarks of Semiconductor Components Industries, LLC dba ON Semiconductor or its subsidiaries in the United States and/or other countries. ON Semiconductor reserves the right to make changes without further notice to any products herein. ON Semiconductor makes no warranty, representation or guarantee regarding the suitability of its products for any particular purpose, nor does ON Semiconductor assume any liability arising out of the application or use of any product or circuit, and specifically disclaims any and all liability, including without limitation special, consequential or incidental damages. ON Semiconductor does not convey any license under its patent rights nor the rights of others.

**SOIC-8 NB**  
**CASE 751-07**  
**ISSUE AK**

DATE 16 FEB 2011

- |  |   |   |   |
|--|---|---|---|
| <p><b>STYLE 1:</b><br/> PIN 1. EMITTER<br/> 2. COLLECTOR<br/> 3. COLLECTOR<br/> 4. EMITTER<br/> 5. EMITTER<br/> 6. BASE<br/> 7. BASE<br/> 8. EMITTER</p>   | <p><b>STYLE 2:</b><br/> PIN 1. COLLECTOR, DIE, #1<br/> 2. COLLECTOR, #1<br/> 3. COLLECTOR, #2<br/> 4. COLLECTOR, #2<br/> 5. BASE, #2<br/> 6. EMITTER, #2<br/> 7. BASE, #1<br/> 8. EMITTER, #1</p>               | <p><b>STYLE 3:</b><br/> PIN 1. DRAIN, DIE #1<br/> 2. DRAIN, #1<br/> 3. DRAIN, #2<br/> 4. DRAIN, #2<br/> 5. GATE, #2<br/> 6. SOURCE, #2<br/> 7. GATE, #1<br/> 8. SOURCE, #1</p>                            | <p><b>STYLE 4:</b><br/> PIN 1. ANODE<br/> 2. ANODE<br/> 3. ANODE<br/> 4. ANODE<br/> 5. ANODE<br/> 6. ANODE<br/> 7. ANODE<br/> 8. COMMON CATHODE</p>   |
| <p><b>STYLE 5:</b><br/> PIN 1. DRAIN<br/> 2. DRAIN<br/> 3. DRAIN<br/> 4. DRAIN<br/> 5. GATE<br/> 6. GATE<br/> 7. SOURCE<br/> 8. SOURCE</p>   | <p><b>STYLE 6:</b><br/> PIN 1. SOURCE<br/> 2. DRAIN<br/> 3. DRAIN<br/> 4. SOURCE<br/> 5. SOURCE<br/> 6. GATE<br/> 7. GATE<br/> 8. SOURCE</p>  | <p><b>STYLE 7:</b><br/> PIN 1. INPUT<br/> 2. EXTERNAL BYPASS<br/> 3. THIRD STAGE SOURCE<br/> 4. GROUND<br/> 5. DRAIN<br/> 6. GATE 3<br/> 7. SECOND STAGE Vd<br/> 8. FIRST STAGE Vd</p>                    | <p><b>STYLE 8:</b><br/> PIN 1. COLLECTOR, DIE #1<br/> 2. BASE, #1<br/> 3. BASE, #2<br/> 4. COLLECTOR, #2<br/> 5. COLLECTOR, #2<br/> 6. EMITTER, #2<br/> 7. EMITTER, #1<br/> 8. COLLECTOR, #1</p>                              |
| <p><b>STYLE 9:</b><br/> PIN 1. EMITTER, COMMON<br/> 2. COLLECTOR, DIE #1<br/> 3. COLLECTOR, DIE #2<br/> 4. EMITTER, COMMON<br/> 5. EMITTER, COMMON<br/> 6. BASE, DIE #2<br/> 7. BASE, DIE #1<br/> 8. EMITTER, COMMON</p> | <p><b>STYLE 10:</b><br/> PIN 1. GROUND<br/> 2. BIAS 1<br/> 3. OUTPUT<br/> 4. GROUND<br/> 5. GROUND<br/> 6. BIAS 2<br/> 7. INPUT<br/> 8. GROUND</p>  | <p><b>STYLE 11:</b><br/> PIN 1. SOURCE 1<br/> 2. GATE 1<br/> 3. SOURCE 2<br/> 4. GATE 2<br/> 5. DRAIN 2<br/> 6. DRAIN 2<br/> 7. DRAIN 1<br/> 8. DRAIN 1</p>   | <p><b>STYLE 12:</b><br/> PIN 1. SOURCE<br/> 2. SOURCE<br/> 3. SOURCE<br/> 4. GATE<br/> 5. DRAIN<br/> 6. DRAIN<br/> 7. DRAIN<br/> 8. DRAIN</p>   |
| <p><b>STYLE 13:</b><br/> PIN 1. N.C.<br/> 2. SOURCE<br/> 3. SOURCE<br/> 4. GATE<br/> 5. DRAIN<br/> 6. DRAIN<br/> 7. DRAIN<br/> 8. DRAIN</p>  | <p><b>STYLE 14:</b><br/> PIN 1. N-SOURCE<br/> 2. N-GATE<br/> 3. P-SOURCE<br/> 4. P-GATE<br/> 5. P-DRAIN<br/> 6. P-DRAIN<br/> 7. N-DRAIN<br/> 8. N-DRAIN</p>   | <p><b>STYLE 15:</b><br/> PIN 1. ANODE 1<br/> 2. ANODE 1<br/> 3. ANODE 1<br/> 4. ANODE 1<br/> 5. CATHODE, COMMON<br/> 6. CATHODE, COMMON<br/> 7. CATHODE, COMMON<br/> 8. CATHODE, COMMON</p>               | <p><b>STYLE 16:</b><br/> PIN 1. EMITTER, DIE #1<br/> 2. BASE, DIE #1<br/> 3. EMITTER, DIE #2<br/> 4. BASE, DIE #2<br/> 5. COLLECTOR, DIE #2<br/> 6. COLLECTOR, DIE #2<br/> 7. COLLECTOR, DIE #1<br/> 8. COLLECTOR, DIE #1</p> |
| <p><b>STYLE 17:</b><br/> PIN 1. VCC<br/> 2. V2OUT<br/> 3. V1OUT<br/> 4. TXE<br/> 5. RXE<br/> 6. VEE<br/> 7. GND<br/> 8. ACC</p>  | <p><b>STYLE 18:</b><br/> PIN 1. ANODE<br/> 2. ANODE<br/> 3. SOURCE<br/> 4. GATE<br/> 5. DRAIN<br/> 6. DRAIN<br/> 7. CATHODE<br/> 8. CATHODE</p>   | <p><b>STYLE 19:</b><br/> PIN 1. SOURCE 1<br/> 2. GATE 1<br/> 3. SOURCE 2<br/> 4. GATE 2<br/> 5. DRAIN 2<br/> 6. MIRROR 2<br/> 7. DRAIN 1<br/> 8. MIRROR 1</p>   | <p><b>STYLE 20:</b><br/> PIN 1. SOURCE (N)<br/> 2. GATE (N)<br/> 3. SOURCE (P)<br/> 4. GATE (P)<br/> 5. DRAIN<br/> 6. DRAIN<br/> 7. DRAIN<br/> 8. DRAIN</p>   |
| <p><b>STYLE 21:</b><br/> PIN 1. CATHODE 1<br/> 2. CATHODE 2<br/> 3. CATHODE 3<br/> 4. CATHODE 4<br/> 5. CATHODE 5<br/> 6. COMMON ANODE<br/> 7. COMMON ANODE<br/> 8. CATHODE 6</p>  | <p><b>STYLE 22:</b><br/> PIN 1. I/O LINE 1<br/> 2. COMMON CATHODE/VCC<br/> 3. COMMON CATHODE/VCC<br/> 4. I/O LINE 3<br/> 5. COMMON ANODE/GND<br/> 6. I/O LINE 4<br/> 7. I/O LINE 5<br/> 8. COMMON ANODE/GND</p> | <p><b>STYLE 23:</b><br/> PIN 1. LINE 1 IN<br/> 2. COMMON ANODE/GND<br/> 3. COMMON ANODE/GND<br/> 4. LINE 2 IN<br/> 5. LINE 2 OUT<br/> 6. COMMON ANODE/GND<br/> 7. COMMON ANODE/GND<br/> 8. LINE 1 OUT</p> | <p><b>STYLE 24:</b><br/> PIN 1. BASE<br/> 2. EMITTER<br/> 3. COLLECTOR/ANODE<br/> 4. COLLECTOR/ANODE<br/> 5. CATHODE<br/> 6. CATHODE<br/> 7. COLLECTOR/ANODE<br/> 8. COLLECTOR/ANODE</p>                                      |
| <p><b>STYLE 25:</b><br/> PIN 1. VIN<br/> 2. N/C<br/> 3. REXT<br/> 4. GND<br/> 5. IOUT<br/> 6. IOUT<br/> 7. IOUT<br/> 8. IOUT</p>   | <p><b>STYLE 26:</b><br/> PIN 1. GND<br/> 2. dv/dt<br/> 3. ENABLE<br/> 4. ILIMIT<br/> 5. SOURCE<br/> 6. SOURCE<br/> 7. SOURCE<br/> 8. VCC</p>  | <p><b>STYLE 27:</b><br/> PIN 1. ILIMIT<br/> 2. OVLO<br/> 3. UVLO<br/> 4. INPUT+<br/> 5. SOURCE<br/> 6. SOURCE<br/> 7. SOURCE<br/> 8. DRAIN</p>  | <p><b>STYLE 28:</b><br/> PIN 1. SW_TO_GND<br/> 2. DASIC OFF<br/> 3. DASIC_SW_DET<br/> 4. GND<br/> 5. V_MON<br/> 6. VBULK<br/> 7. VBULK<br/> 8. VIN</p>  |
| <p><b>STYLE 29:</b><br/> PIN 1. BASE, DIE #1<br/> 2. EMITTER, #1<br/> 3. BASE, #2<br/> 4. EMITTER, #2<br/> 5. COLLECTOR, #2<br/> 6. COLLECTOR, #2<br/> 7. COLLECTOR, #1<br/> 8. COLLECTOR, #1</p>                        | <p><b>STYLE 30:</b><br/> PIN 1. DRAIN 1<br/> 2. DRAIN 1<br/> 3. GATE 2<br/> 4. SOURCE 2<br/> 5. SOURCE 1/DRAIN 2<br/> 6. SOURCE 1/DRAIN 2<br/> 7. SOURCE 1/DRAIN 2<br/> 8. GATE 1</p>                           |   |   |

<b>DOCUMENT NUMBER:</b>	<b>98ASB42564B</b>	Electronic versions are uncontrolled except when accessed directly from the Document Repository. Printed versions are uncontrolled except when stamped "CONTROLLED COPY" in red.
<b>DESCRIPTION:</b>	<b>SOIC-8 NB</b>	<b>PAGE 2 OF 2</b>

ON Semiconductor and  are trademarks of Semiconductor Components Industries, LLC dba ON Semiconductor or its subsidiaries in the United States and/or other countries. ON Semiconductor reserves the right to make changes without further notice to any products herein. ON Semiconductor makes no warranty, representation or guarantee regarding the suitability of its products for any particular purpose, nor does ON Semiconductor assume any liability arising out of the application or use of any product or circuit, and specifically disclaims any and all liability, including without limitation special, consequential or incidental damages. ON Semiconductor does not convey any license under its patent rights nor the rights of others.

ON Semiconductor and  are trademarks of Semiconductor Components Industries, LLC dba ON Semiconductor or its subsidiaries in the United States and/or other countries. ON Semiconductor owns the rights to a number of patents, trademarks, copyrights, trade secrets, and other intellectual property. A listing of ON Semiconductor's product/patent coverage may be accessed at [www.onsemi.com/site/pdf/Patent-Marking.pdf](http://www.onsemi.com/site/pdf/Patent-Marking.pdf). ON Semiconductor reserves the right to make changes without further notice to any products herein. ON Semiconductor makes no warranty, representation or guarantee regarding the suitability of its products for any particular purpose, nor does ON Semiconductor assume any liability arising out of the application or use of any product or circuit, and specifically disclaims any and all liability, including without limitation special, consequential or incidental damages. Buyer is responsible for its products and applications using ON Semiconductor products, including compliance with all laws, regulations and safety requirements or standards, regardless of any support or applications information provided by ON Semiconductor. "Typical" parameters which may be provided in ON Semiconductor data sheets and/or specifications can and do vary in different applications and actual performance may vary over time. All operating parameters, including "Typicals" must be validated for each customer application by customer's technical experts. ON Semiconductor does not convey any license under its patent rights nor the rights of others. ON Semiconductor products are not designed, intended, or authorized for use as a critical component in life support systems or any FDA Class 3 medical devices or medical devices with a same or similar classification in a foreign jurisdiction or any devices intended for implantation in the human body. Should Buyer purchase or use ON Semiconductor products for any such unintended or unauthorized application, Buyer shall indemnify and hold ON Semiconductor and its officers, employees, subsidiaries, affiliates, and distributors harmless against all claims, costs, damages, and expenses, and reasonable attorney fees arising out of, directly or indirectly, any claim of personal injury or death associated with such unintended or unauthorized use, even if such claim alleges that ON Semiconductor was negligent regarding the design or manufacture of the part. ON Semiconductor is an Equal Opportunity/Affirmative Action Employer. This literature is subject to all applicable copyright laws and is not for resale in any manner.

## PUBLICATION ORDERING INFORMATION

### LITERATURE FULFILLMENT:

Email Requests to: [orderlit@onsemi.com](mailto:orderlit@onsemi.com)

ON Semiconductor Website: [www.onsemi.com](http://www.onsemi.com)

### TECHNICAL SUPPORT

North American Technical Support:  
Voice Mail: 1 800-282-9855 Toll Free USA/Canada  
Phone: 011 421 33 790 2910

### Europe, Middle East and Africa Technical Support:

Phone: 00421 33 790 2910

For additional information, please contact your local Sales Representative