

5 V, 1 A H-Bridge Motor Driver

DESCRIPTION

The SiP2100 is an integrated, buffered H-bridge with TTL and CMOS compatible inputs with the capability of delivering up to 1 A continuous current at 5 V V_{DD} supply.

The SiP2100 has two independent logic inputs that can set four different motor operation modes: normal rotation, reverse rotation, stop (idling) and braking. The internal shoot-through protection logic also prevents upper and lower outputs from being turned on simultaneously.

The SiP2100 offers high efficiency with an extremely low operating current. The device also benefits from over temperature protection with a shut down hysteresis of 20 °C.

The SiP2100 is available in SOIC8 package.

FEATURES

- 1 A drive capability
- Optimized for 5 V V_{DD} bias
- Extremely low idle current
- Shoot-through protection scheme
- Thermal shutdown
- Material categorization: For definitions of compliance please see www.vishay.com/doc?99912



RoHS
COMPLIANT
HALOGEN
FREE

APPLICATIONS

- High performance servo
- Optical/tape disk drives
- Brush/stepper motor driver

PACKAGE OUTLINE

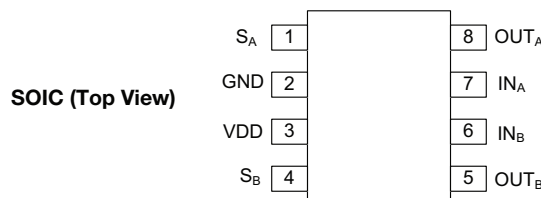

Fig. 1 - Package and Pinout

FUNCTIONAL BLOCK DIAGRAM AND TRUTH TABLE

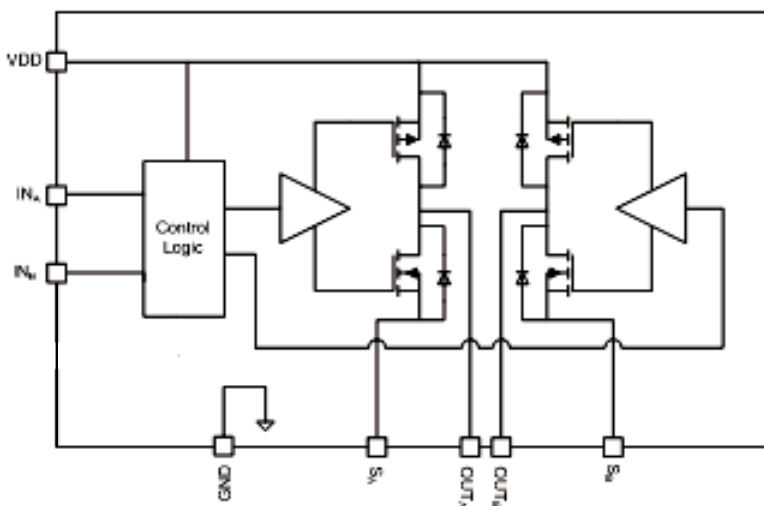

Fig. 2 - Functional Block Diagram

TRUTH TABLE			
IN _A	IN _B	OUT _A	Out _B
1	0	1	0
0	1	0	1
0	0	0	0
1	1	HiZ	HiZ



ABSOLUTE MAXIMUM RATINGS ($T_A = 25\text{ }^\circ\text{C}$, unless otherwise noted)			
Electrical Parameter	Conditions	Limits	Unit
V_{DD}	Reference to GND	- 0.3 to 6	V
OUT_A, OUT_B	Reference to GND	- 0.3 to 6	
S_A, S_B	Reference to GND	- 0.3 to 1	
IN_A, IN_B	Reference to GND	- 0.3 to V_{DD}	
Temperature			
Operating Temperature		- 40 to 85	$^\circ\text{C}$
Max. Operating Junction Temperature		150	

Stresses beyond those listed under "Absolute Maximum Ratings" may cause permanent damage to the device. These are stress ratings only, and functional operation of the device at these or any other conditions beyond those indicated in the operational sections of the specifications is not implied. Exposure to absolute maximum rating/conditions for extended periods may affect device reliability.

RECOMMENDED OPERATING CONDITIONS				
Parameter	Min.	Typ.	Max.	Unit
V_{DD}	3.8	5	5.5	V
Temperature				
Operating Junction Temperature	0		125	$^\circ\text{C}$
Recommended Ambient Temperature	0		70	

THERMAL RESISTANCE RATINGS			
Parameter		Max.	Unit
Thermal Resistance (Junction to Ambient)	SO-8, R_{thJA}	153	$^\circ\text{C}/\text{W}$
	SO-8 PowerPAD, R_{thJC}	40	
Power Dissipation	SO-8, $T_A = 70\text{ }^\circ\text{C}$	522	mW
	SO-8 PowerPAD, $T_A = 70\text{ }^\circ\text{C}$	2	W
Junction Temperature		- 65 to 150	$^\circ\text{C}$
Storage Temperature		- 55 to 150	



SPECIFICATIONS ($T_A = 25\text{ }^\circ\text{C}$, unless otherwise specified)							
Parameter	Symbol	Test Conditions $V_{DD} = 5\text{ V}$	Limits			Unit	
			Min. ^a	Typ. ^b	Max. ^a		
Driver Power Supply							
V_{DD} Bias Supply Current	I_{DD}	IN = 100 kHz		250	300	μA	
		IN = 20 kHz		150	180		
		Quiescent state		50			
V_{DD} Rising Threshold	$V_{DD\ TH_R}$	V_{DD} rising		2.8	3	V	
V_{DD} Falling Threshold	$V_{DD\ TH_F}$	V_{DD} falling	2	2.5			
V_{DD} UVLO Hysteresis	$V_{DD\ UVLO}$			300		mV	
Input Logic							
Input Voltage High	V_{IN_H}		2			V	
Input Voltage Low	V_{IN_L}				0.7		
Input Sourcing Current	I_{IN_H}				1	μA	
Input Sinking Current	I_{IN_L}		-1				
Output Stage							
Output Voltage High	V_{OUT_H}	$I_{OUT} = -500\text{ mA}$	$V_{DD} = 4.75\text{ V}$	4.4		V	
		$I_{OUT} = -1000\text{ mA}$		4.25			
Output Voltage Low	V_{OUT_L}	$I_{OUT} = +500\text{ mA}$					0.25
		$I_{OUT} = +1000\text{ mA}$					0.5
Output High Propagation Delay	TP_{LH}			20	25	nS	
Output Low Propagation Delay	TP_{HL}			20	25		
Thermal Protection							
Thermal Shutdown Threshold				150		$^\circ\text{C}$	
Thermal Shutdown Hysteresis				20			

Notes:

a. Pulse test; pulse width $\leq 300\text{ }\mu\text{s}$, duty cycle $\leq 2\%$.

b. Guaranteed by design, not subject to production testing.

PIN DESCRIPTION (SOIC PACKAGE)		
Pin Number	Name	Function
1	S_A	Driver output return A
2	GND	Analog ground of internal logic
3	V_{DD}	Input of internal logic bias and power stage
4	S_B	Driver output return B
5	OUT_B	Driver output B
6	IN_B	Driver input B
7	IN_A	Driver input A
8	OUT_A	Driver output A

TYPICAL CHARACTERISTICS (25 °C, unless otherwise noted)

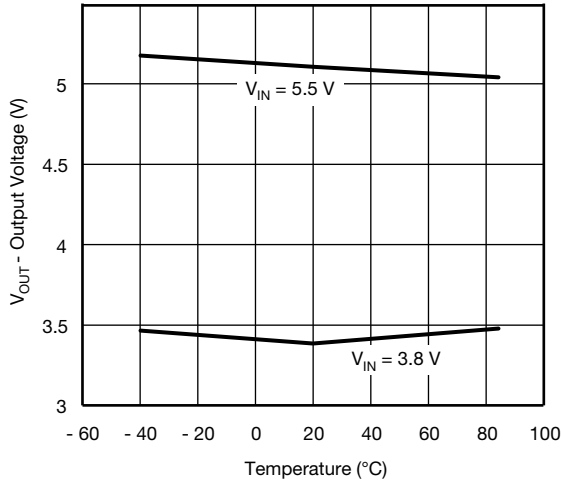

Fig 1. Output Voltage vs. Temperature (at 1.5 A Load)

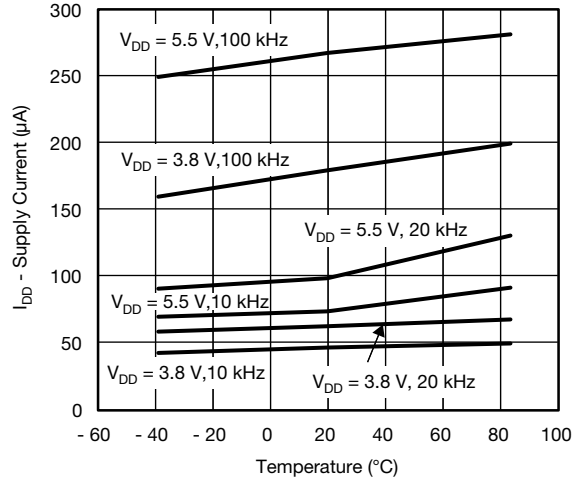

Fig 2. Supply Current I_{DD} vs. Temperature

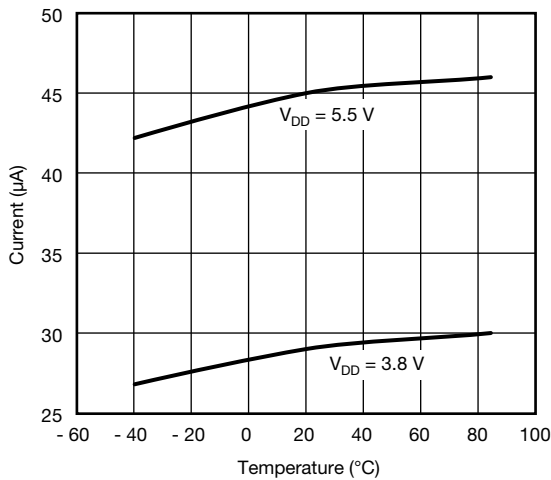

Fig 3. Quiescent Current vs. Temperature

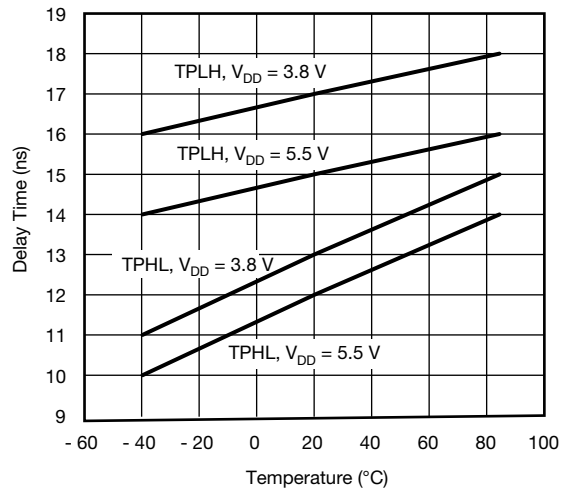

Fig 4. Propagation Delay vs. Temperature

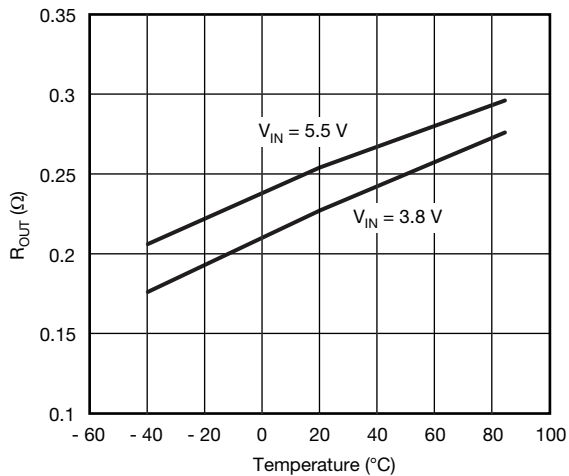

Fig 5. R_{OUT} vs. Temperature

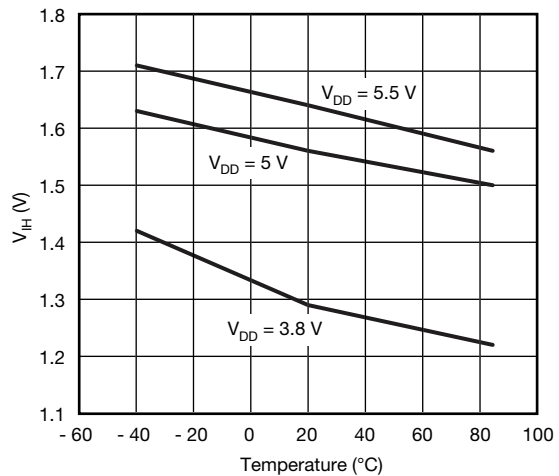
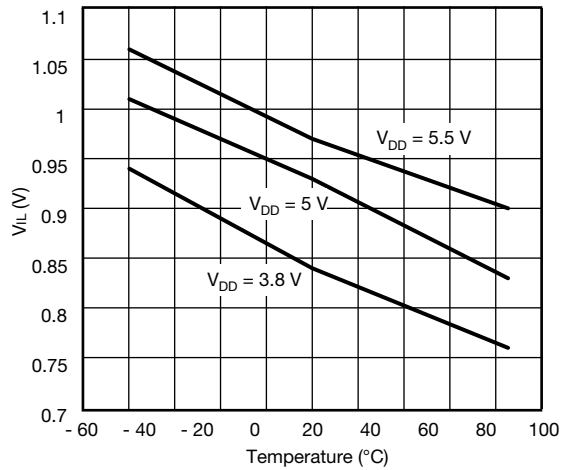

Fig 6. PWM Rising Threshold vs. Temperature

TYPICAL CHARACTERISTICS (25 °C, unless otherwise noted)

Fig 7. PWM Falling Threshold vs. Temperature

Vishay Siliconix maintains worldwide manufacturing capability. Products may be manufactured at one of several qualified locations. Reliability data for Silicon Technology and Package Reliability represent a composite of all qualified locations. For related documents such as package/tape drawings, part marking, and reliability data, see www.vishay.com/ppg?63949.

SOIC (NARROW): 8-LEAD

JEDEC Part Number: MS-012



DIM	MILLIMETERS		INCHES	
	Min	Max	Min	Max
A	1.35	1.75	0.053	0.069
A ₁	0.10	0.20	0.004	0.008
B	0.35	0.51	0.014	0.020
C	0.19	0.25	0.0075	0.010
D	4.80	5.00	0.189	0.196
E	3.80	4.00	0.150	0.157
e	1.27 BSC		0.050 BSC	
H	5.80	6.20	0.228	0.244
h	0.25	0.50	0.010	0.020
L	0.50	0.93	0.020	0.037
q	0°	8°	0°	8°
S	0.44	0.64	0.018	0.026
ECN: C-06527-Rev. I, 11-Sep-06				
DWG: 5498				



Disclaimer

ALL PRODUCT, PRODUCT SPECIFICATIONS AND DATA ARE SUBJECT TO CHANGE WITHOUT NOTICE TO IMPROVE RELIABILITY, FUNCTION OR DESIGN OR OTHERWISE.

Vishay Intertechnology, Inc., its affiliates, agents, and employees, and all persons acting on its or their behalf (collectively, "Vishay"), disclaim any and all liability for any errors, inaccuracies or incompleteness contained in any datasheet or in any other disclosure relating to any product.

Vishay makes no warranty, representation or guarantee regarding the suitability of the products for any particular purpose or the continuing production of any product. To the maximum extent permitted by applicable law, Vishay disclaims (i) any and all liability arising out of the application or use of any product, (ii) any and all liability, including without limitation special, consequential or incidental damages, and (iii) any and all implied warranties, including warranties of fitness for particular purpose, non-infringement and merchantability.

Statements regarding the suitability of products for certain types of applications are based on Vishay's knowledge of typical requirements that are often placed on Vishay products in generic applications. Such statements are not binding statements about the suitability of products for a particular application. It is the customer's responsibility to validate that a particular product with the properties described in the product specification is suitable for use in a particular application. Parameters provided in datasheets and / or specifications may vary in different applications and performance may vary over time. All operating parameters, including typical parameters, must be validated for each customer application by the customer's technical experts. Product specifications do not expand or otherwise modify Vishay's terms and conditions of purchase, including but not limited to the warranty expressed therein.

Except as expressly indicated in writing, Vishay products are not designed for use in medical, life-saving, or life-sustaining applications or for any other application in which the failure of the Vishay product could result in personal injury or death. Customers using or selling Vishay products not expressly indicated for use in such applications do so at their own risk. Please contact authorized Vishay personnel to obtain written terms and conditions regarding products designed for such applications.

No license, express or implied, by estoppel or otherwise, to any intellectual property rights is granted by this document or by any conduct of Vishay. Product names and markings noted herein may be trademarks of their respective owners.