

## FEATURES

**Nonreflective, 50  $\Omega$  design**

**High isolation: 45 dB typical at 2 GHz**

**Low insertion loss: 0.6 dB at 2 GHz**

**High power handling**

33 dBm through path

27 dBm terminated path

**High linearity**

1 dB compression (P1dB): 35 dBm typical

Input third-order intercept (IIP3): 58 dBm typical

**ESD rating: 2 kV human body model (HBM), Class 2**

**Single positive supply: 3.3 V to 5.0 V**

**Standard TTL-, CMOS-, and 1.8 V-compatible control**

**16-lead, 3 mm  $\times$  3 mm LFCSP package (9 mm<sup>2</sup>)**

**Pin compatible with the [HMC241ALP3E](#)**

## APPLICATIONS

Cellular/4G infrastructure

Wireless infrastructure

Automotive telematics

Mobile radios

Test equipment

## GENERAL DESCRIPTION

The HMC7992 is a general-purpose, nonreflective, 0.1 GHz to 6.0 GHz, silicon, single-pole, four-throw (SP4T) switch in a leadless, surface-mount package. The switch is ideal for cellular infrastructure applications, offers high isolation of 45 dB typical at 2 GHz, and a low insertion loss of 0.6 dB at 2 GHz. It offers excellent power handling capability up to 6.0 GHz, with input power of 1 dB compression point (P1dB) of 35 dBm at 5 V operation. The HMC7992 has good low frequency input power handling below 0.1 GHz and can operate well down to 10 kHz, with a typical 1 dB compression of 21 dBm (see Figure 21) and an IIP3 of 37 dBm (see Figure 22) at 1 MHz.

## FUNCTIONAL BLOCK DIAGRAM

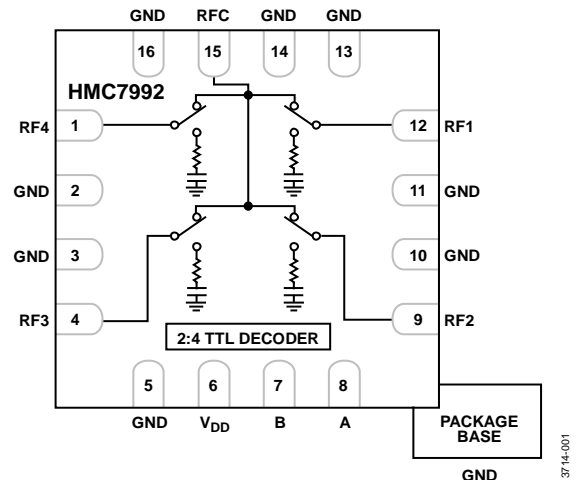

Figure 1.

The on-chip circuitry allows the HMC7992 to operate at a single, positive supply voltage range from 3.3 V to 5 V, and as well as a single, positive control voltage from 0 V to 1.8 V/3.3 V/5.0 V. A 2:4 decoder integrated in the switch requires only two controlled input signals, with a positive control voltage range from 0 V to 1.8 V/3.3 V/5.0 V, to select one of the four radio frequency (RF) paths.

**TABLE OF CONTENTS**

Features .....	1	Insertion Loss, Isolation, and Return Loss .....	6
Applications.....	1	Input Compression and Input Third-Order Intercept (0.1 GHz to 6.0 GHz).....	8
Functional Block Diagram .....	1	Input Compression and Input Third-Order Intercept (10 kHz to 1 GHz) .....	9
General Description .....	1	Theory of Operation .....	10
Revision History .....	2	Applications Information .....	11
Specifications.....	3	Outline Dimensions .....	12
Absolute Maximum Ratings.....	4	Ordering Guide .....	12
ESD Caution.....	4		
Pin Configuration and Function Descriptions.....	5		
Interface Schematics.....	5		
Typical Performance Characteristics .....	6		

**REVISION HISTORY**

**8/2019—Rev. 0 to Rev. A**

Changes to Specifications Section and Table 1 .....	3
Deleted Table 2 and Table 3; Renumbered Sequentially .....	4
Changes to Table 3.....	5
Moved Table 4 .....	10
Deleted Table 5.....	10
Changes to Ordering Guide .....	12

**1/2016—Revision 0: Initial Version**

## SPECIFICATIONS

$V_{DD} = 3.3\text{ V to }5.0\text{ V}$ ,  $V_{CTL} = 0\text{ V}/V_{DD}$ ,  $T_{CASE} = 25^\circ\text{C}$ ,  $50\ \Omega$  system, unless otherwise noted.

Table 1.

Parameter	Symbol	Test Conditions/Comments	Min	Typ	Max	Unit		
INSERTION LOSS		0.1 GHz to 2.0 GHz		0.6	0.9	dB		
		2.0 GHz to 4.0 GHz		0.7	1.1	dB		
		4.0 GHz to 6.0 GHz		1.0	1.5	dB		
ISOLATION RFC to RF1 to RF4 (Worst Case)		0.1 GHz to 2.0 GHz	40	45		dB		
		2.0 GHz to 4.0 GHz	32	37		dB		
		4.0 GHz to 6.0 GHz	25	30		dB		
RETURN LOSS		On State		25		dB		
				24		dB		
				17		dB		
		Off State		7		dB		
				15		dB		
				20		dB		
SWITCHING SPEED		Rise Time and Fall Time	$t_{RISE}, t_{FALL}$	10% to 90% of RF output	30	ns		
		On Time and Off Time	$t_{ON}, t_{OFF}$	50% of $V_{CTL}$ to 90% of RF output	150	ns		
RADIO FREQUENCY (RF) SETTling TIME		50% $V_{CTL}$ to 0.1 dB margin of final $RF_{OUT}$		320		ns		
INPUT POWER COMPRESSION		0.1 GHz to 6.0 GHz	P1dB	$V_{DD} = 5\text{ V}$	35	dB		
				$V_{DD} = 3.3\text{ V}$	33	dB		
				$V_{DD} = 5\text{ V}$	33	dB		
				$V_{DD} = 3.3\text{ V}$	31	dB		
INPUT THIRD-ORDER INTERCEPT	IIP3	0.1 GHz to 6.0 GHz, two-tone input power = 14 dBm/tone		$V_{DD} = 5\text{ V}$	58	dBm		
				$V_{DD} = 3.3\text{ V}$	56	dBm		
DIGITAL CONTROL VOLTAGES		<1 $\mu\text{A}$ typical	$V_{IL}$	$V_{DD} = 3.3\text{ V}$ ( $\pm 5\% V_{DD}$ )	0	0.85	V	
				$V_{DD} = 5\text{ V}$ ( $\pm 5\% V_{DD}$ )	0	1.2	V	
				$V_{DD} = 3.3\text{ V}$ ( $\pm 5\% V_{DD}$ )	1.15	3.3	V	
				$V_{DD} = 5\text{ V}$ ( $\pm 5\% V_{DD}$ )	1.55	5.0	V	
BIAS AND SUPPLY CURRENT	$I_{DD}$			$V_{DD} = 3.3\text{ V}$	0.16	0.20	mA	
				$V_{DD} = 5\text{ V}$	0.18	0.23	mA	
RECOMMENDED OPERATING CONDITIONS		0.1 GHz to 6.0 GHz	$V_{DD}$ $V_{CTL}$ $T_{CASE}$	Bias Voltage Range	3.0	5.4	V	
				Control Voltage Range	0	$V_{DD}$	V	
				Case Temperature Range	-40	+105	$^\circ\text{C}$	
				Maximum RF Input Power Through Path	$V_{DD}/V_{CTL} = 5\text{ V}$ , $T_{CASE} = 105^\circ\text{C}$	30		dBm
					$V_{DD}/V_{CTL} = 5\text{ V}$ , $T_{CASE} = -40^\circ\text{C to }+85^\circ\text{C}$	33		dBm
					$V_{DD}/V_{CTL} = 3.3\text{ V}$ , $T_{CASE} = 105^\circ\text{C}$	29		dBm
					$V_{DD}/V_{CTL} = 3.3\text{ V}$ , $T_{CASE} = -40^\circ\text{C to }+85^\circ\text{C}$	32		dBm
				Terminated Path	$V_{DD}/V_{CTL} = 3.3\text{ V to }5\text{ V}$ , $T_{CASE} = 105^\circ\text{C}$	21		dBm
					$V_{DD}/V_{CTL} = 3.3\text{ V to }5\text{ V}$ , $T_{CASE} = 85^\circ\text{C}$	24		dBm
					$V_{DD}/V_{CTL} = 3.3\text{ V to }5\text{ V}$ , $T_{CASE} = 25^\circ\text{C}$	27		dBm
					$V_{DD}/V_{CTL} = 3.3\text{ V to }5\text{ V}$ , $T_{CASE} = -40^\circ\text{C}$	27		dBm
				Hot Switching	$V_{DD}/V_{CTL} = 3.3\text{ V to }5\text{ V}$ , $T_{CASE} = 105^\circ\text{C}$	24		dBm
					$V_{DD}/V_{CTL} = 3.3\text{ V to }5\text{ V}$ , $T_{CASE} = -40^\circ\text{C to }+85^\circ\text{C}$	27		dBm

## ABSOLUTE MAXIMUM RATINGS

Table 2.

Parameter	Rating
Bias Voltage Range ( $V_{DD}$ )	-0.3 V to +5.5 V
Control Voltage Range (A, B)	-0.5 V to $V_{DD} + (+0.5 V)$
RF Input Power, <sup>1</sup> 3.3 V to 5 V (see Figure 2 and Figure 3)	
Through Path	34 dBm
Terminated Path	28 dBm
Hot Switching	30 dBm
Channel Temperature	135°C
Storage Temperature Range	-65°C to +150°C
Maximum Peak Reflow Temperature (MSL3)	260°C
Thermal Resistance (Channel to Package Bottom)	
Through Path	115°C
Terminated Path	200°C
ESD Sensitivity	
Human Body Model (HBM)	2 kV (Class 2)
Charged Device Model (CDM)	1.25 kV

<sup>1</sup> For recommended operating conditions, see Table 1.

Stresses at or above those listed under Absolute Maximum Ratings may cause permanent damage to the product. This is a stress rating only; functional operation of the product at these or any other conditions above those indicated in the operational section of this specification is not implied. Operation beyond the maximum operating conditions for extended periods may affect product reliability.

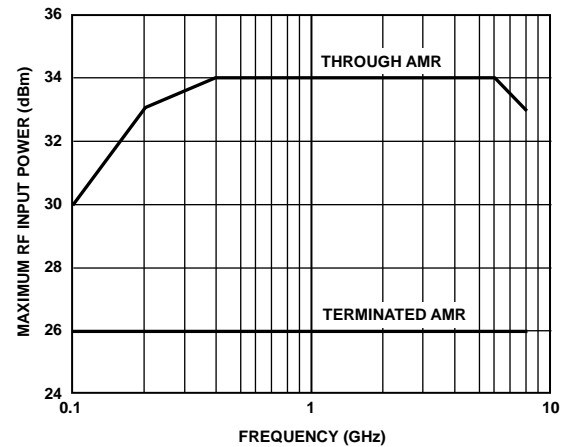

Figure 2. Maximum RF Input Power vs. Frequency

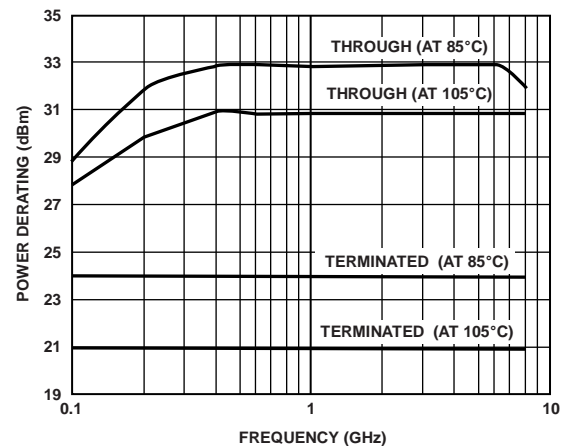

Figure 3. Power Derating vs. Frequency

### ESD CAUTION



**ESD (electrostatic discharge) sensitive device.** Charged devices and circuit boards can discharge without detection. Although this product features patented or proprietary protection circuitry, damage may occur on devices subjected to high energy ESD. Therefore, proper ESD precautions should be taken to avoid performance degradation or loss of functionality.

## PIN CONFIGURATION AND FUNCTION DESCRIPTIONS

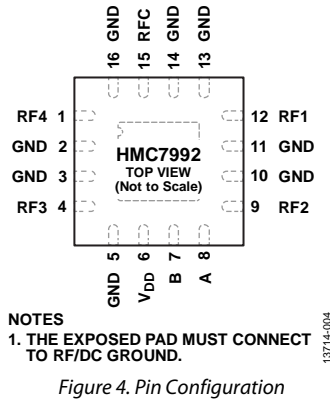

Figure 4. Pin Configuration

Table 3. Pin Function Descriptions

Pin No.	Mnemonic	Description
1	RF4	RF Port 4. This pin is dc-coupled and matched to 50 Ω. A dc blocking capacitor is required on this pin.
2, 3, 5, 10, 11, 13, 14, 16	GND	Ground. The package bottom has an exposed metal pad that must connect to the printed circuit board (PCB) RF/dc ground. See Figure 5 for the GND interface schematic.
4	RF3	RF Port 3. This pin is dc-coupled and matched to 50 Ω. A dc blocking capacitor is required on this pin.
6	V <sub>DD</sub>	Supply Voltage.
7	B	Logic Control Input B. See Figure 6 for the control input interface schematic. See Table 4 and the recommended input control voltages range in Table 1.
8	A	Logic Control Input A. See Figure 6 for the control input interface schematic. See Table 4 and the recommended input control voltages range in Table 1.
9	RF2	RF Port 2. This pin is dc-coupled and matched to 50 Ω. A dc blocking capacitor is required on this pin.
12	RF1	RF Port 1. This pin is dc-coupled and matched to 50 Ω. A dc blocking capacitor is required on this pin.
15	RFC	RF Common Port. This pin is dc-coupled and matched to 50 Ω. A dc blocking capacitor is required on this pin.
	EPAD	Exposed Pad. The exposed pad must connect to RF/dc ground.

## INTERFACE SCHEMATICS



Figure 5. GND Interface Schematic

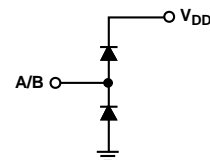

Figure 6. Logic Control (A/B) Interface Schematic

# TYPICAL PERFORMANCE CHARACTERISTICS

## INSERTION LOSS, ISOLATION, AND RETURN LOSS

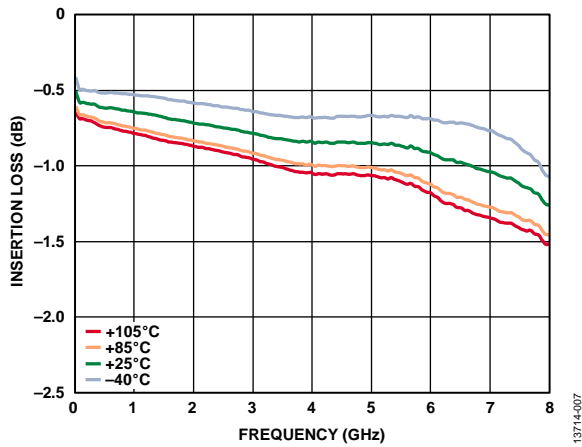

Figure 7. Insertion Loss vs. Frequency for Various Temperatures,  $V_{DD} = 5\text{ V}$

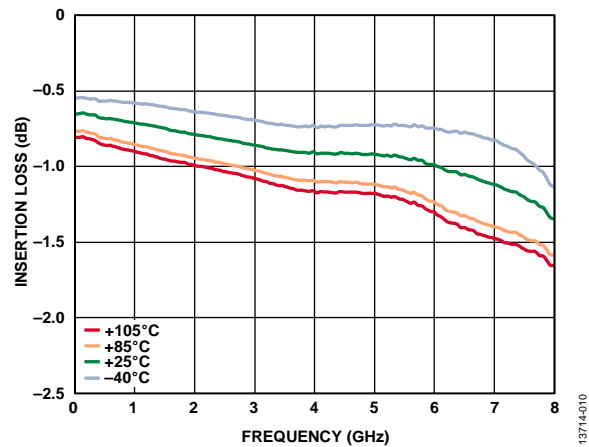

Figure 10. Insertion Loss vs. Frequency for Various Temperatures,  $V_{DD} = 3.3\text{ V}$

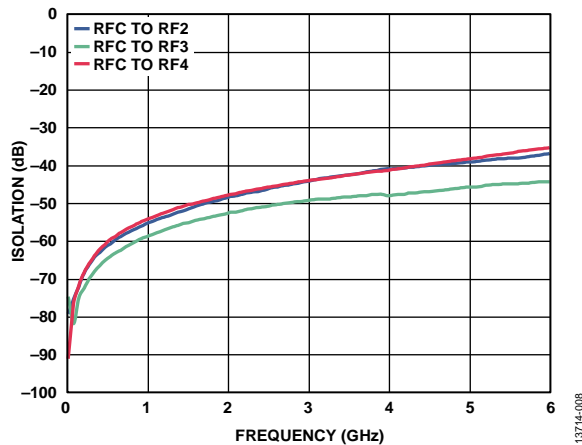

Figure 8. Isolation vs. Frequency,  $V_{DD} = 3.3\text{ V to }5\text{ V}$ , RFC to RF1 = On

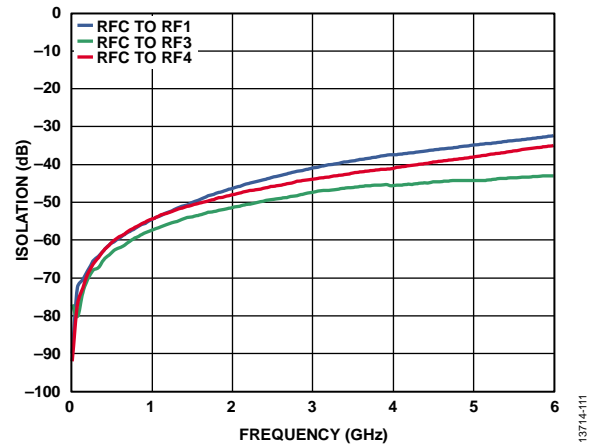

Figure 11. Isolation vs. Frequency,  $V_{DD} = 3.3\text{ V to }5\text{ V}$ , RFC to RF2 = On

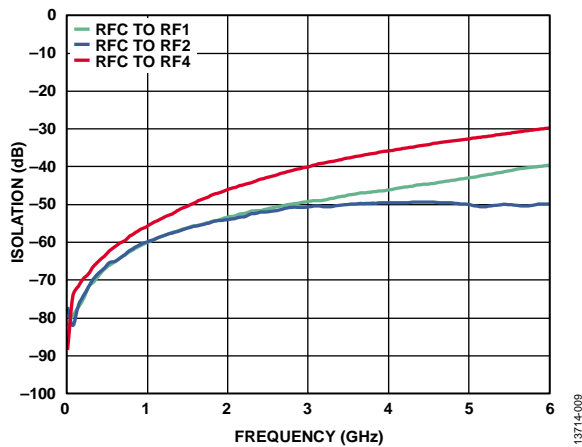

Figure 9. Isolation vs. Frequency,  $V_{DD} = 3.3\text{ V to }5\text{ V}$ , RFC to RF3 = On

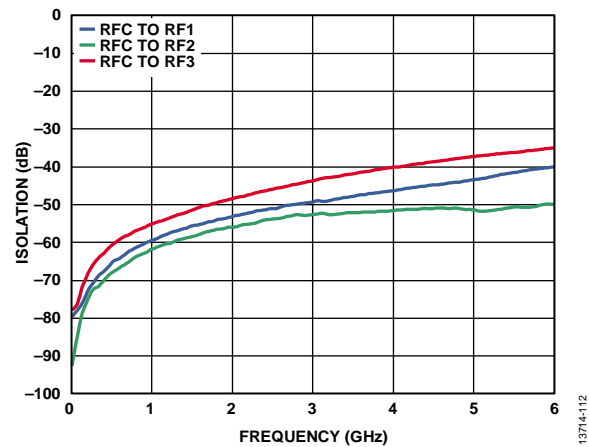

Figure 12. Isolation vs. Frequency,  $V_{DD} = 3.3\text{ V to }5\text{ V}$ , RFC to RF4 = On

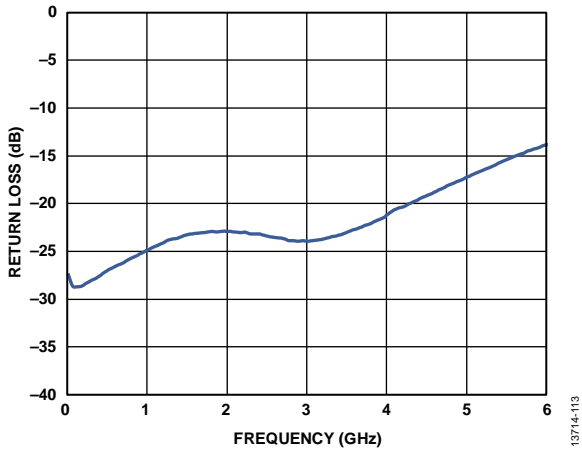

Figure 13. Return Loss for RFC vs. Frequency,  $V_{DD} = 3.3\text{ V to }5\text{ V}$

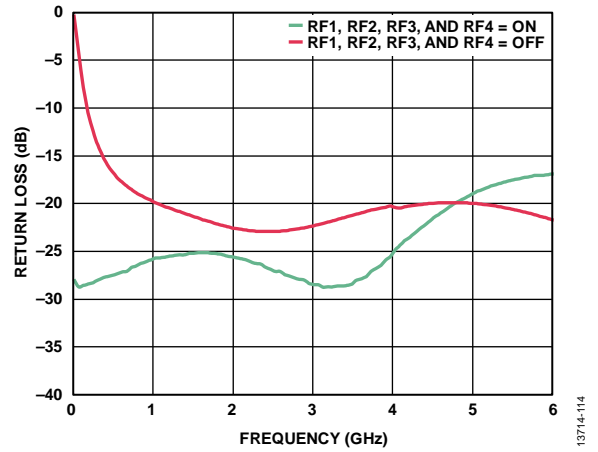

Figure 14. Return Loss for RF1, RF2, RF3, and RF4 vs. Frequency,  $V_{DD} = 3.3\text{ V to }5\text{ V}$

INPUT COMPRESSION AND INPUT THIRD-ORDER INTERCEPT (0.1 GHz TO 6.0 GHz)

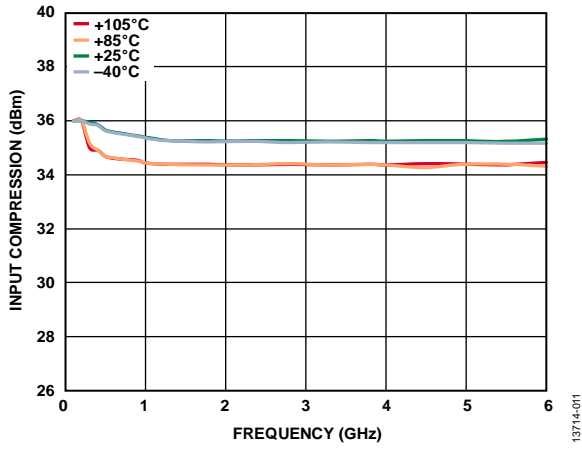

Figure 15. Input Compression 1 dB Point vs. Frequency for Various Temperatures,  $V_{DD} = 5 V$

13714-011

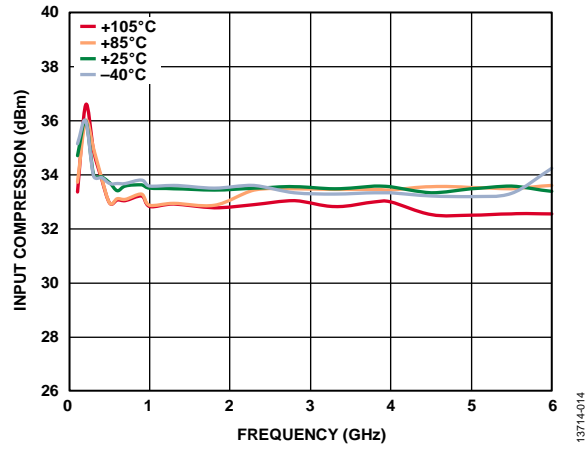

Figure 18. Input Compression 1 dB Point vs. Frequency for Various Temperatures,  $V_{DD} = 3.3 V$

13714-014

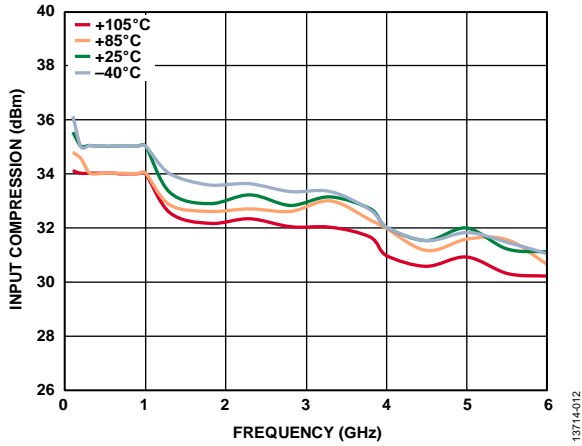

Figure 16. Input Compression 0.1 dB Point vs. Frequency for Various Temperatures,  $V_{DD} = 5 V$

13714-012

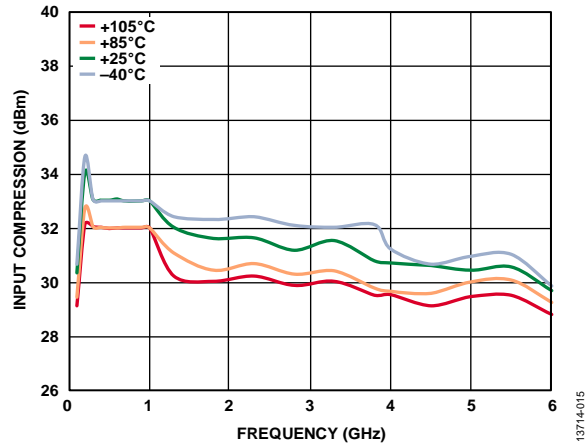

Figure 19. Input Compression 0.1 dB Point vs. Frequency for Various Temperatures,  $V_{DD} = 3.3 V$

13714-015

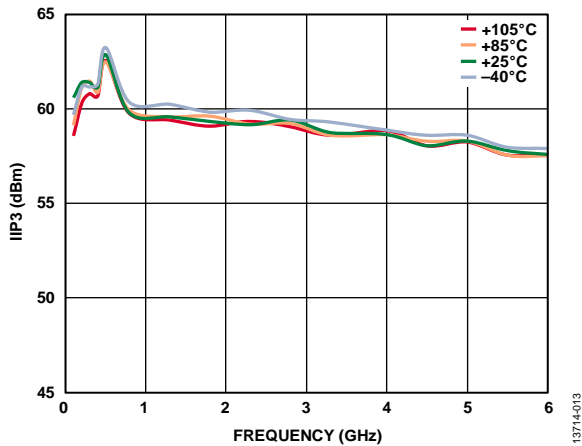

Figure 17. Input Third-Order Intercept (IIP3) Point vs. Frequency for Various Temperatures,  $V_{DD} = 5 V$

13714-013

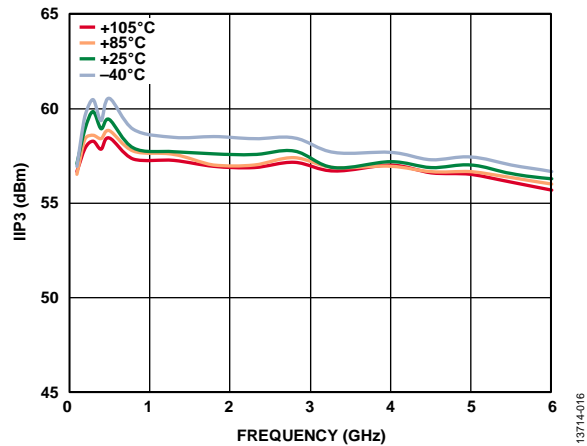

Figure 20. Input Third-Order Intercept (IIP3) Point vs. Frequency for Various Temperatures,  $V_{DD} = 3.3 V$

13714-016



**INPUT COMPRESSION AND INPUT THIRD-ORDER INTERCEPT (10 kHz TO 1 GHz)**

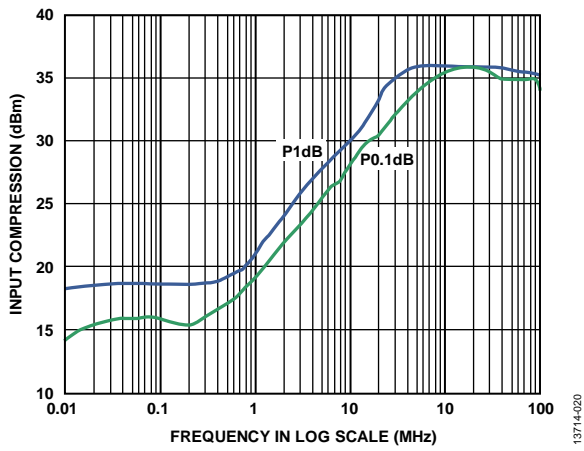

Figure 21. Input Compression (P1dB and P0.1dB Points) vs. Frequency in Log Scale,  $V_{DD} = 5\text{ V}$  at  $25^\circ\text{C}$

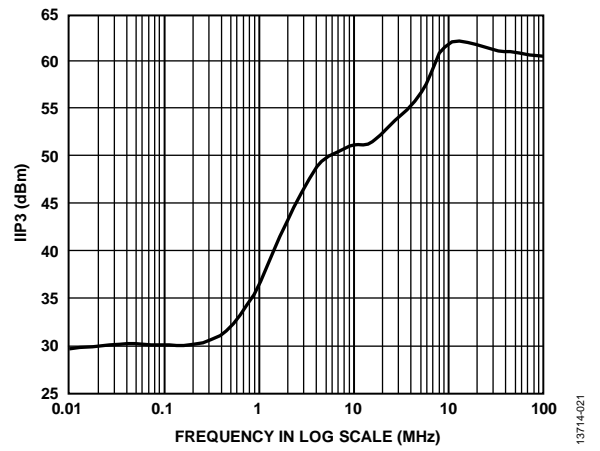

Figure 22. Input Third-Order Intercept (IIP3) vs. Frequency in Log Scale,  $V_{DD} = 5\text{ V}$  at  $25^\circ\text{C}$

## THEORY OF OPERATION

The HMC7992 requires a single positive supply voltage applied to the  $V_{DD}$  pin. A bypassing capacitor is recommended on the supply line to minimize RF coupling.

The HMC7992 integrates with an internal 2:4 decoder; the four RF paths are selected via the two digital control voltages applied to the A and B control inputs. A small value bypassing capacitor is recommended on these digital signal lines to improve the RF signal isolation.

The HMC7992 is internally matched to  $50\ \Omega$  at the RF common port (RFC) and the RF ports (RF1, RF2, RF3, and RF4); therefore, no external matching components are required. The RF pins are dc-coupled and dc blocking capacitors are required on the RF paths. The design is bidirectional; the RF input signals can apply at the RFC port or the RF1 to RF4 ports. The inputs and outputs are interchangeable.

Depending on the logic level applied to the control input pins, A and B, one RF output port (for example, RF1) is set to on mode, by which an insertion loss path is provided from the input to the output. The other RF output ports (for example, RF2, RF3, and RF4) are then set to off mode, by which the outputs are isolated from the input. When the RF output ports (RF1, RF2, RF3, and RF4) are in isolation mode, they are internally terminated to  $50\ \Omega$ , and thereby can absorb the applied RF signal.

The ideal power-up sequence is as follows:

1. Power up GND.
2. Power up  $V_{DD}$ .
3. Power up the digital control inputs. The relative order of the logic control inputs is not important. Powering the logic control inputs before the  $V_{DD}$  supply can inadvertently forward bias and damage the internal ESD protection structures.
4. Apply the RF input.

**Table 4. Truth Table**

Control Input		Signal Path State
A	B	RFC to
Low	Low	RF1
High	Low	RF2
Low	High	RF3
High	High	RF4

### APPLICATIONS INFORMATION

Generate the evaluation PCB with proper RF circuit design techniques. Signal lines at the RF port must have a 50 Ω impedance, and the package ground leads and backside ground slug must connect directly to the ground plane, as shown in Figure 23. The evaluation board shown in Figure 23 is available from Analog Devices, Inc., upon request.

**Table 5. Bill of Materials for the EV1HMC7992LP3D<sup>1</sup> Evaluation Board**

Reference Designator	Description
J1 to J5	PCB mount SMA connectors
C1 to C5	100 pF capacitors, 0402 package
C8 to C10	100 pF capacitors, 0402 package
C13	0.1 μF capacitor, 0402 package
R1 to R2	0 Ω resistors, 0402 package
U1	<a href="#">HMC7992LP3DE</a> SP4T switch
PCB <sup>2</sup>	600-01284-00 evaluation PCB

<sup>1</sup> Reference this evaluation board number when ordering the complete evaluation board.

<sup>2</sup> Circuit board material: Roger 4350 or Arlon 25FR.

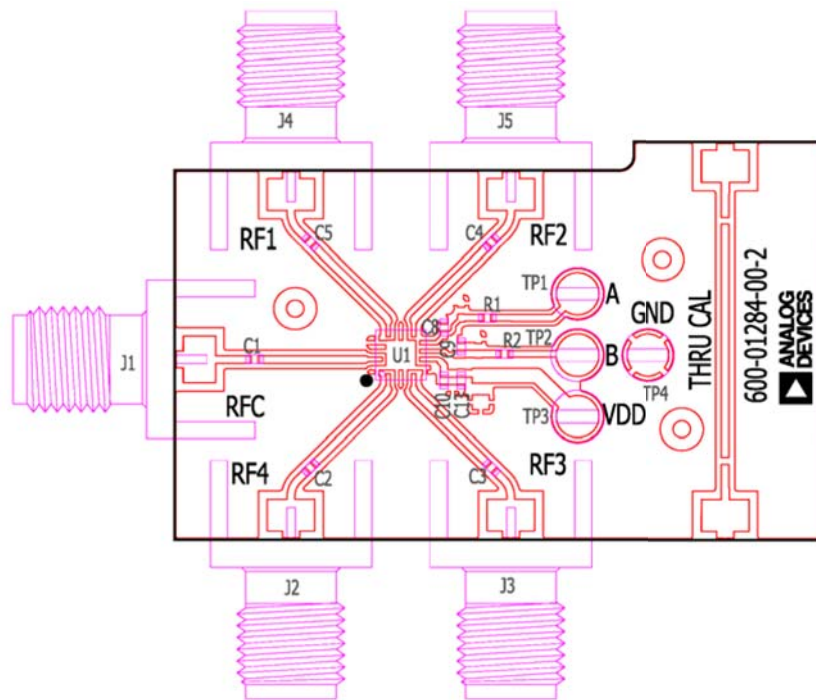
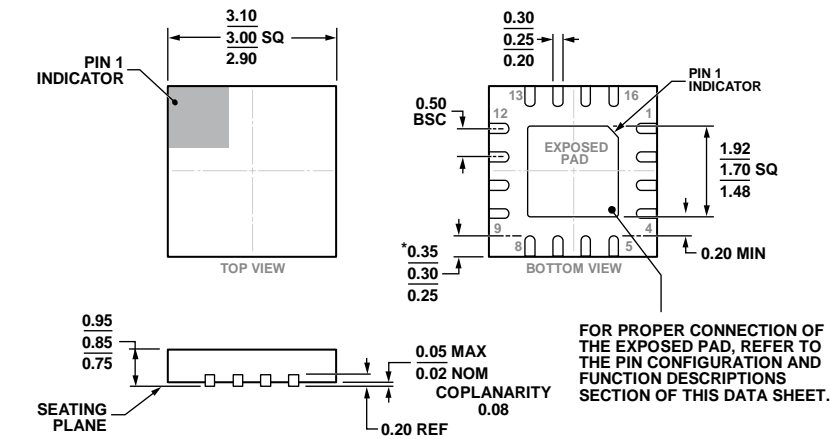

Figure 23. EV1HMC7992LP3D Evaluation Board

13714-017

OUTLINE DIMENSIONS



\*COMPLIANT WITH JEDEC STANDARDS MO-220-VEED-4 WITH THE EXCEPTION OF PACKAGE EDGE TO LEAD EDGE.

Figure 24. 16-Lead Lead Frame Chip Scale Package [LFCSP]  
3 mm x 3 mm Body and 0.85 mm Package Height  
(CP-16-38)

Dimensions shown in millimeters

ORDERING GUIDE

Model <sup>1</sup>	Temperature Range	Package Description	Package Option
HMC7992LP3DE	-40°C to +105°C	16-Lead Lead Frame Chip Scale Package [LFCSP]	CP-16-38
HMC7992LP3DETR	-40°C to +105°C	16-Lead Lead Frame Chip Scale Package [LFCSP]	CP-16-38
EV1HMC7992LP3D		Evaluation Board	

<sup>1</sup> The HMC7992LP3DE and HMC7992LP3DETR are RoHS Compliant Parts.