

100 V power Schottky rectifier

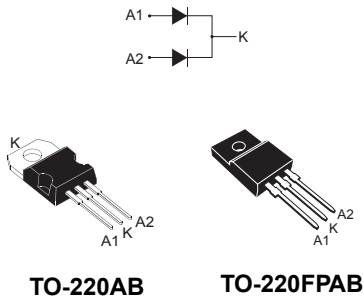

Features

- High junction temperature capability for converters located in confined environment
- Low leakage current at high temperature
- Low static and dynamic losses as a result of the Schottky barrier
- Avalanche specification
- ECOPACK®2 compliant

Applications

- Switching diode
- SMPS
- DC/DC converter
- LED lighting
- Desktop power supply

Description

Schottky barrier rectifier designed for high frequency miniature switched mode power supplies such as adaptors and on board DC/DC converters.

The **STPS20S100C** is housed in TO-220AB and TO-220FPAB packages.

Product status link	
STPS20S100C	
Product summary	
Symbol	Value
$I_{F(AV)}$	2 x 10 A
V_{RRM}	100 V
T_j	175 °C
V_F (typ.)	0.66 V

1 Characteristics

Table 1. Absolute ratings (limiting values at 25 °C, unless otherwise specified, per diode)

Symbol	Parameter			Value	Unit	
V _{RRM}	Repetitive peak reverse voltage			100	V	
I _{F(RMS)}	Forward rms current			30	A	
I _{F(AV)}	Average forward current	TO-220AB	T _c = 155 °C, δ = 0.5	Per diode	10	A
			T _c = 150 °C, δ = 0.5	Per device	20	
		TO-220FPAB	T _c = 135 °C, δ = 0.5	Per diode	10	
			T _c = 115 °C, δ = 0.5	Per device	20	
I _{FSM}	Surge non repetitive forward current		t _p = 10 ms sinusoidal	180	A	
P _{ARM}	Repetitive peak avalanche power		t _p = 10 μs, T _j = 125 °C	518	W	
T _{stg}	Storage temperature range			-65 to +175	°C	
T _j	Maximum operating junction temperature ⁽¹⁾			175	°C	

1. $(dP_{tot}/dT_j) < (1/R_{th(j-a)})$ condition to avoid thermal runaway for a diode on its own heatsink.

Table 2. Thermal resistance parameters

Symbol	Parameter		Max. value	Unit	
R _{th(j-c)}	Junction to case	TO-220AB	Per diode	2.2	°C/W
			Total	1.3	
		TO-220FPAB	Per diode	4.5	
			Total	3.5	
R _{th(c)}	Coupling	TO-220AB	0.3		
		TO-220FPAB	2.5		

When the diodes 1 and 2 are used simultaneously :

$$\Delta T_j(\text{diode 1}) = P(\text{diode1}) \times R_{th(j-c)}(\text{per diode}) + P(\text{diode 2}) \times R_{th(c)}$$

Table 3. Static electrical characteristics (per diode)

Symbol	Parameter	Test conditions		Min.	Typ.	Max.	Unit
I _R ⁽¹⁾	Reverse leakage current	T _j = 25 °C	V _R = V _{RRM}	-		3.5	μA
		T _j = 125 °C		-	1.3	4.5	mA

Symbol	Parameter	Test conditions		Min.	Typ.	Max.	Unit
$V_F^{(2)}$	Forward voltage drop	$T_j = 25\text{ }^\circ\text{C}$	$I_F = 5\text{ A}$	-		0.73	V
		$T_j = 125\text{ }^\circ\text{C}$		-	0.57	0.61	
		$T_j = 25\text{ }^\circ\text{C}$	$I_F = 10\text{ A}$	-		0.85	
		$T_j = 125\text{ }^\circ\text{C}$		-	0.66	0.71	
		$T_j = 25\text{ }^\circ\text{C}$	$I_F = 20\text{ A}$	-		0.94	
		$T_j = 125\text{ }^\circ\text{C}$		-	0.74	0.80	

1. Pulse test: $t_p = 5\text{ ms}$, $\delta < 2\%$

2. Pulse test: $t_p = 380\text{ }\mu\text{s}$, $\delta < 2\%$

To evaluate the conduction losses, use the following equation:

$$P = 0.62 \times I_{F(AV)} + 0.009 \times I_{F(RMS)}^2$$

For more information, please refer to the following application notes related to the power losses :

- AN604: Calculation of conduction losses in a power rectifier
- AN4021: Calculation of reverse losses on a power diode

1.1 Characteristics (curves)

Figure 1. Average forward power dissipation versus average forward current (per diode)

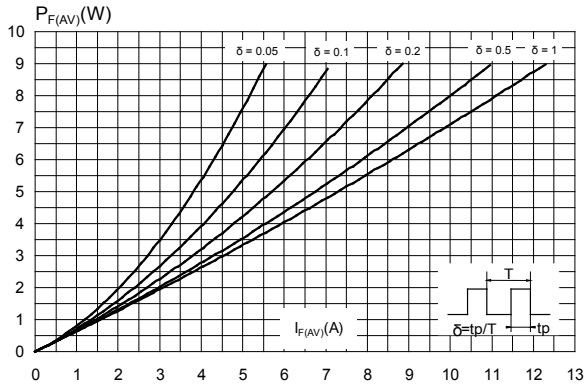

Figure 2. Average forward current versus ambient temperature ($\delta = 0.5$, per diode)

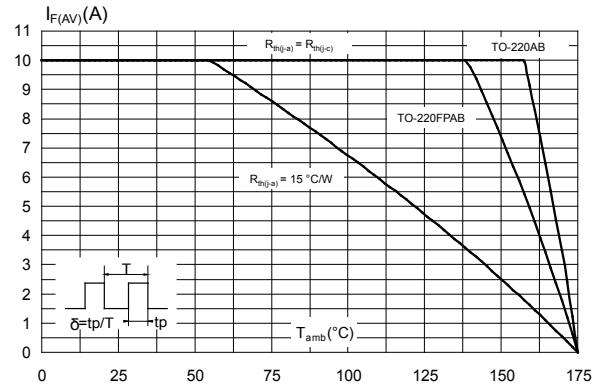

Figure 3. Normalized avalanche power derating versus pulse duration ($T_j = 125\text{ °C}$)

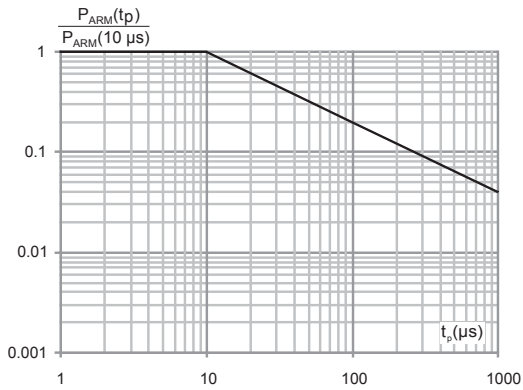

Figure 4. Relative variation of thermal impedance junction to case versus pulse duration (TO-220AB)

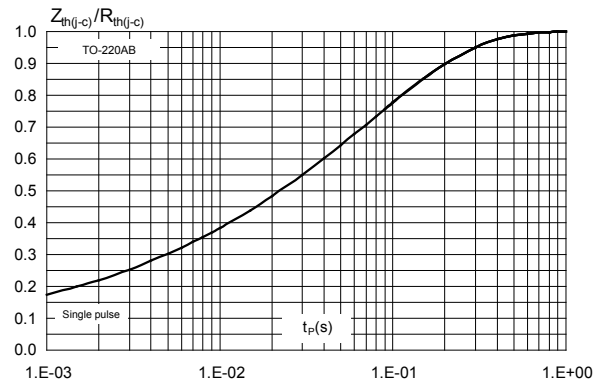

Figure 5. Relative variation of thermal impedance junction to case versus pulse duration (TO-220FPAB)

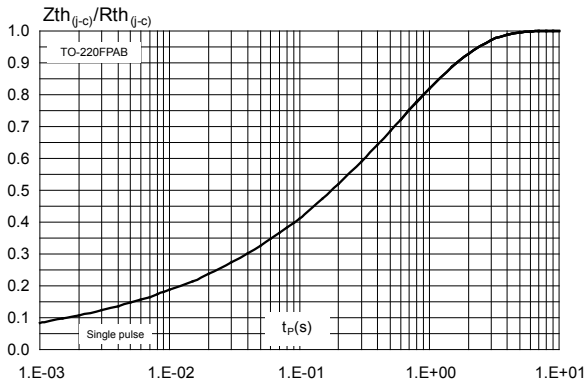

Figure 6. Reverse leakage current versus reverse voltage applied (typical values, per diode)

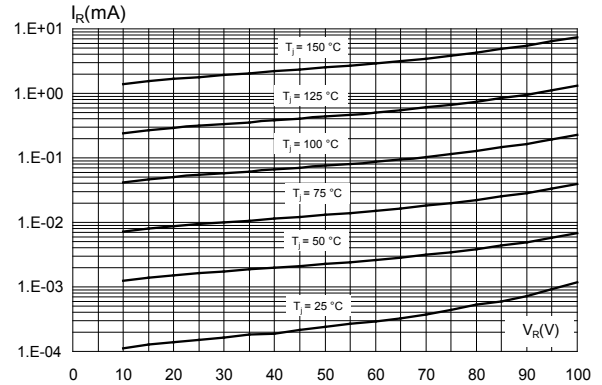

Figure 7. Junction capacitance versus reverse voltage applied (typical values, per diode)

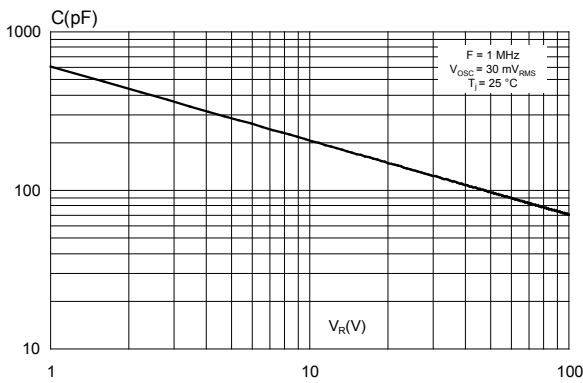
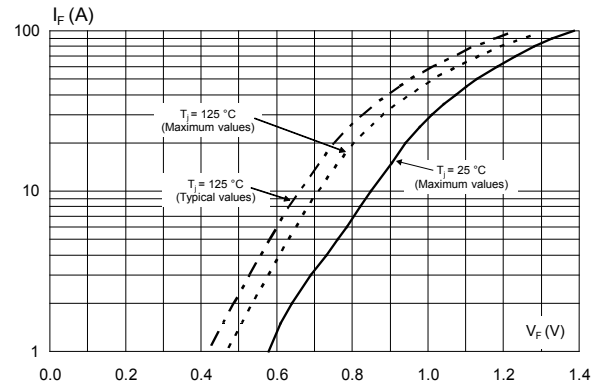

Figure 8. Forward voltage drop versus forward current (per diode)



2 Package information

In order to meet environmental requirements, ST offers these devices in different grades of ECOPACK® packages, depending on their level of environmental compliance. ECOPACK® specifications, grade definitions and product status are available at: www.st.com. ECOPACK® is an ST trademark.

2.1 TO-220FPAB package information

- Epoxy meets UL94, V0
- Cooling method: by conduction (C)
- Recommended torque value: 0.55 N·m
- Maximum torque value: 0.70 N·m

Figure 9. TO-220FPAB package outline

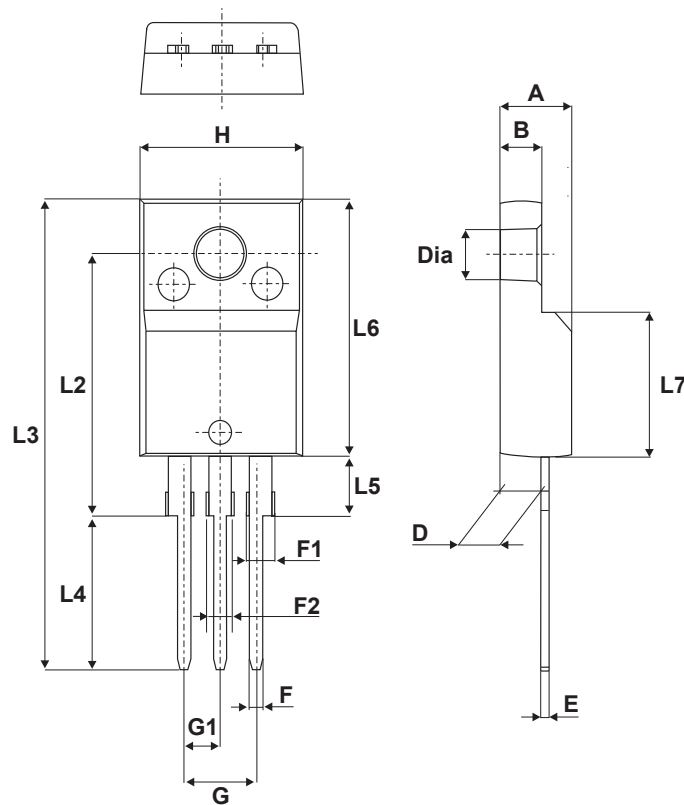

Table 4. TO-220FPAB package mechanical data

Ref.	Dimensions			
	Millimeters		Inches	
	Min.	Max.	Min.	Max.
A	4.40	4.60	0.173	0.181
B	2.50	2.70	0.098	0.106
D	2.50	2.75	0.098	0.108
E	0.45	0.70	0.018	0.027
F	0.75	1.00	0.03	0.039
F1	1.15	1.70	0.045	0.067
F2	1.15	1.70	0.045	0.067
G	4.95	5.20	0.195	0.205
G1	2.40	2.70	0.094	0.106
H	10.00	10.40	0.393	0.409
L2	16.00 typ.		0.63 typ.	
L3	28.60	30.60	1.126	1.205
L4	9.80	10.60	0.386	0.417
L5	2.90	3.60	0.114	0.142
L6	15.90	16.40	0.626	0.646
L7	9.00	9.30	0.354	0.366
Dia	3.00	3.20	0.118	0.126

2.2 TO-220AB package information

- Epoxy meets UL 94, V0
- Cooling method: by conduction (C)
- Recommended torque value: 0.55 N·m
- Maximum torque value: 0.70 N·m

Figure 10. TO-220AB package outline

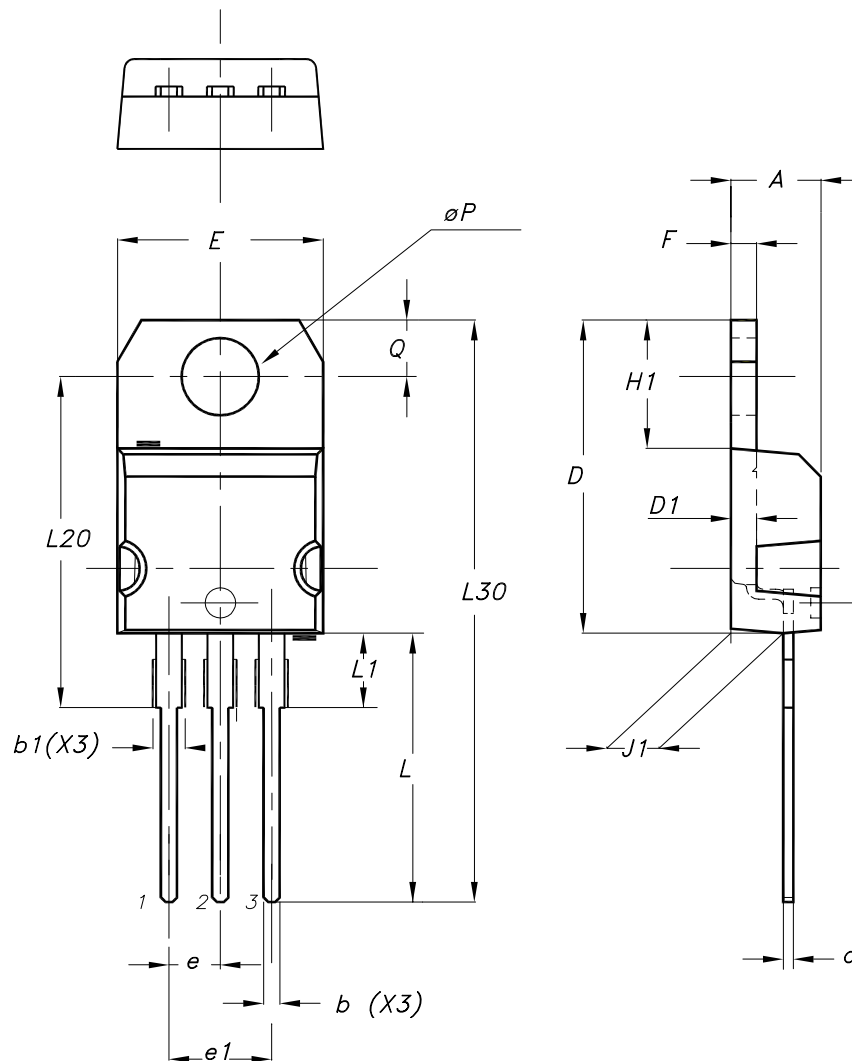

Table 5. TO-220AB package mechanical data

Ref.	Dimensions			
	Millimeters		Inches	
	Min.	Max.	Min.	Max.
A	4.40	4.60	0.173	0.181
b	0.61	0.88	0.240	0.035
b1	1.14	1.55	0.045	0.061

Ref.	Dimensions			
	Millimeters		Inches	
	Min.	Max.	Min.	Max.
c	0.48	0.70	0.019	0.028
D	15.25	15.75	0.600	0.620
D1	1.27 typ.		0.050 typ.	
E	10.00	10.40	0.394	0.409
e	2.40	2.70	0.094	0.106
e1	4.95	5.15	0.195	0.203
F	1.23	1.32	0.048	0.052
H1	6.20	6.60	0.244	0.260
J1	2.40	2.72	0.094	0.107
L	13.00	14.00	0.512	0.551
L1	3.50	3.93	0.138	0.155
L20	16.40 typ.		0.646 typ.	
L30	28.90 typ.		1.138 typ.	
θP	3.75	3.85	0.148	0.152
Q	2.65	2.95	0.104	0.116

3 Ordering information

Table 6. Ordering information

Order code	Marking	Package	Weight	Base qty.	Delivery mode
STPS20S100CT	STPS20S100CT	TO-220AB	1.95 g	50	Tube
STPS20S100CFP	STPS20S100CFP	TO-220FPAB	1.90 g		

Revision history

Table 7. Document revision history

Date	Version	Changes
16-Mar-2005	1	First issue.
03-Feb-2010	2	Added cathode indicator K to illustration of TO-220AB on cover page. Changed parameter in Table 2 from " RMS forward voltage " to " Forward rms current ".
11-May-2018	3	<p>Removed figure 4, figure 5 and figure 6.</p> <p>Updated Figure 3. Normalized avalanche power derating versus pulse duration ($T_j = 125\text{ }^\circ\text{C}$), Table 1. Absolute ratings (limiting values at $25\text{ }^\circ\text{C}$, unless otherwise specified, per diode), Figure 4. Relative variation of thermal impedance junction to case versus pulse duration (TO-220AB) and Figure 5. Relative variation of thermal impedance junction to case versus pulse duration (TO-220FPAB).</p> <p>Updated Section 3 Ordering information.</p> <p>Removed I²PAK package.</p> <p>Minor text changes to improve readability.</p>

IMPORTANT NOTICE – PLEASE READ CAREFULLY

STMicroelectronics NV and its subsidiaries (“ST”) reserve the right to make changes, corrections, enhancements, modifications, and improvements to ST products and/or to this document at any time without notice. Purchasers should obtain the latest relevant information on ST products before placing orders. ST products are sold pursuant to ST’s terms and conditions of sale in place at the time of order acknowledgement.

Purchasers are solely responsible for the choice, selection, and use of ST products and ST assumes no liability for application assistance or the design of Purchasers’ products.

No license, express or implied, to any intellectual property right is granted by ST herein.

Resale of ST products with provisions different from the information set forth herein shall void any warranty granted by ST for such product.

ST and the ST logo are trademarks of ST. All other product or service names are the property of their respective owners.

Information in this document supersedes and replaces information previously supplied in any prior versions of this document.

© 2018 STMicroelectronics – All rights reserved